

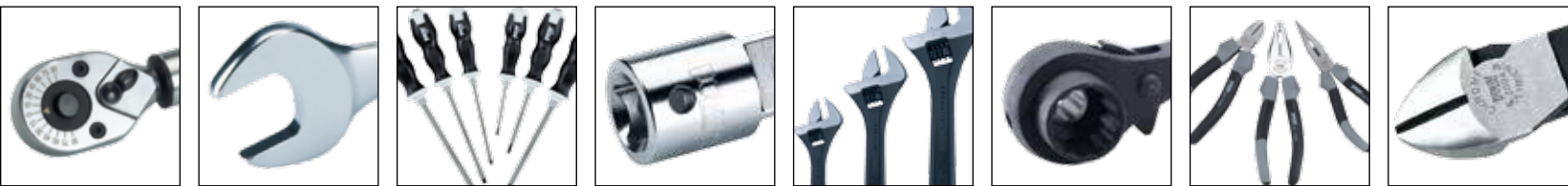

SHIP SUPPLY



HANDTOOL CATALOGUE

DURABILITY, INNOVATION & QUALITY

N° 2017



GLOBAL ASSORTMENT

This symbol indicates that a product is part of Wrist's global assortment.

GLOBAL ASSORTMENT CONSISTENCY IN PRODUCTS

Wrist offers a wide range of global assortment within provisions and stores, ensuring consistency in product quality and pricing wherever you receive your Wrist supplies.

Economies of scale are key to Wrist's purchasing improvement being able to use procurement strengths to secure competitive pricing in the market. Global assortment is available in all key ports.





POLAR® TOOLS IN WRIST'S GLOBAL ASSORTMENT

POLAR® Tools is part of Wrist's global assortment – with Wrist being the sole distributor in ports around the world. POLAR® is a Scandinavian tool brand with a full range of professional hand tools, which currently counts around 2,000 articles. The tools are specially developed for customers who wants high quality and with heavy duty and offshore demands.

POLAR® Tools come with an anti-corrosion warranty for all chrome plated products (wrenches, sockets, extensions adapters, etc.) The market standard for similar products has a chrome plated thickness of typically 6-8 micron. POLAR® Tools have a thickness of 10-12 micron.

POLAR® Tools provide life-time warranty on all products (excl. ratchets, torque wrenches and pneumatic air tools which are covered by standard warranty). The life-time warranty even applies to incorrect use of screwdrivers and sockets.

Bits and screwdrivers are manufactured in S2 special steel, which is much stronger compared to chrome-vanadium steel.

The POLAR® brand stands for professional hand tools, characterized by quality, reliability and usability.

WRENCHES 95 PRODUCTS

PLIERS 36 PRODUCTS

AIRTOOLS 6

SCREWDRIVERS 51 PRODUCTS

SOCKETS & ACCESSORIES 108 PRODUCTS

HAMMERS & CHISELS 28 PRODUCTS

VARIOUS ITEMS 17 PRODUCTS



- WRIST BRANCHES
- REPRESENTATIVE OFFICES

ABOUT WRIST



Wrist Ship Supply is the world's leading ship and offshore supplier of provisions and stores with a global market share around 8%. Wrist offers a global 24/7/365 service, including handling of owners' goods, shipping, airfreight and related marine services that meet the demands of multi-national organisations as well as local businesses. From offices around the globe all Wrist staff take pride in making it easy for the customers to receive their supplies, wherever and whenever requested – efficiently and at the best possible price. Wrist's promise is expressed in its mission: Expert Care to Each Ship & Offshore Location.

www.wrist.com.



CONTACT US

EUROPE

AALBORG

WRIST EUROPE A/S (DENMARK)
Tel.: +45 98 13 72 77
Email: wrist@wrist.com

ABERDEEN

STRACHANS LTD. (SCOTLAND)
Tel.: +44 1224 897 767
Email: aberdeen@strachans.co.uk

ALGECIRAS

WRIST SHIP SUPPLY SPAIN S.L. (SPAIN)
Tel.: +34 956 675 078
Email: algeciras@wrist.com

DEN HELDER

DEN HELDER STORES B.V.
(THE NETHERLANDS)
Tel.: +31 223 635587
Email: info@denhelderstores.nl

ESBJERG

JENS LYSHOLDTS EFTF. A/S (DENMARK)
Tel.: +45 75 12 10 22
Email: dsc@lysholdt.dk

GREAT YARMOUTH

STRACHANS LTD. (UNITED KINGDOM)
Tel.: +44 1493 850337
Email: yarmouth@strachans.co.uk

HAMBURG

WRIST SHIP SUPPLY GERMANY GMBH
(GERMANY)
Tel.: +49 40 299 971 90
Email: hamburg@wrist.com

HAUGESUND

WRIST EUROPE AS (NORWAY)
Tel.: +47 5285 6690
Email: norway@wrist.com

LAS PALMAS

WRIST SHIP SUPPLY SPAIN S.L. (SPAIN)
Tel.: +34 928 475 177
Email: laspalmas@wrist.com

MARSEILLE

WRIST EUROPE SAS (FRANCE)
Tel.: +33 467 748 427
Email: marseille@wrist.com

PETERHEAD

STRACHANS LTD. (SCOTLAND)
Tel.: +44 1779 485300
Email: peterhead@strachans.co.uk

ROTTERDAM

WRIST-KOOYMAN SHIP SUPPLY B.V.
(THE NETHERLANDS)
Tel.: +31 10 428 4300 (Wrist)
Tel.: +31 10 753 6753 (Kooyman)
Email: rotterdam@wrist.com

FAR EAST

GUANGZHOU

WRIST (SHENZHEN) TRADING
COMPANY LTD. (CHINA)
Tel.: +86 1892 3758 608
Email: china@wrist.com

SINGAPORE

WRIST FAR EAST PTE. LTD.
(SINGAPORE)
Tel.: +65 6318 0000
Email: singapore@wrist.com

MIDDLE EAST

DUBAI

WRIST MIDDLE EAST (UAE) LLC.
Tel.: +971 6 514 7400
Email: dubai@wrist.com

MALDIVES

COSMOPOLITAN CHAMPA BROTHERS
PVT. LTD. (MALDIVES)
Tel.: +960 331 0477
Email: rito@wrist.com

NORTH AMERICA

CORPUS CHRISTI

WORLD SHIP SUPPLY
Tel.: +1 361 289 7380
Email: usgulf@wrist.com

HOUSTON

WRIST USA (USA)
Tel.: +1 281 817 2060
Email: usgulf@wrist.com

JACKSONVILLE / SAVANNAH

WORLD SHIP SUPPLY (USA)
Tel.: +1 904 768 1015
Email: usgulf@wrist.com

LONG BEACH / LOS ANGELES

WEST COAST SHIP SUPPLY (USA)
Tel.: +1 562 435 5245
Email: westcoast@wrist.com

MONTREAL

KARLO CORPORATION (CANADA)
Tel.: +1 514 255 5017
Email: canada@wrist.com

NEW ORLEANS

WORLD SHIP SUPPLY (USA)
Tel.: +1 504 586 0767
Email: usgulf@wrist.com

NEW YORK

EAST COAST SHIP SUPPLY LLC. (USA)
Tel.: +1 732 205 9790
Email: eastcoast@wrist.com

PORTLAND

WEST COAST SHIP SUPPLY (USA)
Tel.: +1 503 224 9950
Email: westcoast@wrist.com

SAN FRANCISCO / OAKLAND

WEST COAST SHIP SUPPLY (USA)
Tel.: +1 510 444 7200
Email: westcoast@wrist.com

SEATTLE

WEST COAST SHIP SUPPLY (USA)
Tel.: +1 206 716 3001
Email: westcoast@wrist.com

VANCOUVER

KARLO CORPORATION SUPPLY &
SERVICES (CANADA)
Tel.: +1 604 205 5466
Email: vancouver@wrist.com

REPRESENTATIVE OFFICES

ASIA

ASIA REPRESENTATIVE OFFICE
Tel.: +65 9841 3247
Email: roph@wrist.com

GERMANY

GERMANY REPRESENTATIVE OFFICE
Tel.: +49 402 999 7190
Mobile: +49 172 984 9400
Email: caml@wrist.com

GREECE

GREECE REPRESENTATIVE OFFICE
Tel.: +30 216 70 04341
Mobile: +30 693 27 69653
Email: lidi@wrist.com

NORWAY

NORWAY REPRESENTATIVE OFFICE
Mobile: +47 9017 2312
Email: bvr@wrist.com

THE PHILIPPINES

PHILIPPINES REPRESENTATIVE OFFICE
Tel.: + 63 917 325 2158
Mobile: + 63 939 921 3090
Email: lina@wrist.com



SOCKETS & ACCESSORIES

*POLAR® sockets and ratchets are designed to fit and built to perform for a lifetime.
Made from high grade chrome vanadium steel for a stronger and more durable tool.*



5314 E 1/4" REVERSIBLE RATCHET W/ LOCKING SYSTEM

- Model with 60 teeth and Quick Release.
- Compact head with working angle of 6°.

 PAGE 155



5314 B 1/4" REVERSIBLE RATCHET W/ LOCKING SYSTEM

- Model with 48 teeth and Quick Release.
- Compact head with working angle of 7,5°.

 PAGE 155



5338 3/8" REVERSIBLE RATCHET W/ LOCKING SYSTEM

- Model with 60 teeth and Quick Release.
- Compact head with working angle of 6°.

 PAGE 158



5312 1/2" REVERSIBLE RATCHET W/ LOCKING SYSTEM

- Model with 60 teeth and Quick Release.
- Compact head with a working angle of 6°.

 PAGE 169



5212 EX 1/2" EXTENSIONS

- With ext. 22 mm Hexagon.

 PAGE 166



5212 EXW 1/2" WOBBLE EXTENSIONS

- With ext. 22 mm Hexagon.

 PAGE 167



5412 TH 1/2" SLIDING T-HANDLE

 PAGE 169



5812 U 1/2" UNIVERSAL JOINT

- Equipped with tension-spring. Joint stays at desired angle.

 PAGE 169



6012 1/2" 6-POINT METRIC IMPACT SOCKETS

 PAGE 188



5014 1/4" 6-POINT METRIC SOCKETS

▪ Sizes: From 5 - 13 mm  PAGE 152



5738 A 3/8" ADAPTOR FROM 3/8" TO 1/4"

 PAGE 158



5034 3/4" 6-POINT METRIC SOCKETS

▪ Sizes: From 24 - 38 mm  PAGE 170



5638 A 3/8" ADAPTOR FROM 3/8" TO 1/2"

 PAGE 158



5012 1/2" 6-POINT METRIC SOCKETS

▪ Sizes: From 8 - 32 mm  PAGE 159



5712 A 1/2" ADAPTOR FROM 1/2" TO 3/8"

 PAGE 167



5012 B 1/2" 12-POINT METRIC SOCKETS

▪ Sizes: From 10 - 32 mm  PAGE 160



5612 A 1/2" ADAPTOR FROM 1/2" TO 3/4"

 PAGE 167



5012 L 1/2" 6-POINT LONG METRIC SOCKETS

▪ Sizes: From 10 - 24 mm  PAGE 159



5734 A 3/4" ADAPTOR FROM 3/4" TO 1/2"

 PAGE 170



5614 A 1/4" ADAPTOR FROM 1/4" TO 3/8"

 PAGE 154



WRENCHES

POLAR® wrenches are manufactured according to international standards, from high grade chrome vanadium steel, giving you the professional quality known by all POLAR® products.



2000 METRIC COMBINATION WRENCH

- 12-Point ring angled at 15°. Open end angled at 15°.
- Sizes: From 6 - 60 mm

 PAGE 95



2100 METRIC COMBINATION WRENCH OFFSET

- 12-Point ring angled at 70°. Open end angled at 15°.
- Surface: Chrome plated finish, with polished heads
- Sizes: From 6 - 32 mm

 PAGE 98



2005 REVERSIBLE METRIC GEAR COMBINATION WRENCH

- Reversible model with 72 teeth and a working angle of 5°.
- 12-Point ring angled at 15°. Open end angled at 15°.
- Sizes: From 8 - 24 mm

 PAGE 97



2110 METRIC DOUBLE END OFFSET RING WRENCHES

- 12-Point ring angled at 70°.
- Surface: Satin chrome finish. Material: Chrome-vanadium steel.
- Sizes: From 8 x 10 - 30 x 32 mm

 PAGE 99



2010 METRIC DOUBLE OPEN END WRENCH

- Open end angled at 15°.
- Sizes: From 6 x 7 - 24 x 27 mm

 PAGE 97



2600 ADJUSTABLE WRENCH

- Grinded head tip and 15° angel. Scale in mm. Left knurling.
- Sizes: From 4" - 24"

 PAGE 102



2000 METRIC WRENCH SET - 26 PCS.

- Supplied in nylon bag.
- Sizes: From 6 - 32 mm

 PAGE 96



2091 METRIC DOUBLE OPEN END WRENCH SET - 12 PCS.

- Supplied in nylon bag.
- Sizes: From 6 x 7 - 30 x 32 mm

 PAGE 98



2095 REVERSIBLE GEAR COMBINATION WRENCH SET - 12 PCS.

- Supplied in nylon bag.
- Sizes: From 8 - 19 mm

 PAGE 97



2091 METRIC DOUBLE OPEN END WRENCH SET - 8 PCS.

- Supplied in nylon bag.
- Sizes: From 6 x 7 - 20 x 22 mm

 PAGE 97



7100 TORQUE WRENCH

- Adjustable torque wrench with reversible ratchet.
- Sizes: 1/4", 3/8", 1/2" and 3/4".

 PAGE 104



PLIERS

POLAR® pliers give you control and comfort. The quality forged steel ensures strength and durability. The handles are designed to offer increased leverage and power.



3001 COMBINATION PLIER

- Model with cutter for piano wire (200 kg/mm²) and knurled gripping surface.

 PAGE 113



3020 BOX-JOINT WATER PUMP PLIER

- Model with 7 positions and knurled gripping surface.

 PAGE 114



3002 DIAGONAL CUTTER

- Model with cutter for hard wire (160 kg/mm²).

 PAGE 113



3006 HALF-ROUND NOSE PLIER WITH BENT JAWS

- Model with cutter for hard wire (160 kg/mm²) and knurled gripping surface.

 PAGE 113



3005 HALF-ROUND LONG NOSE PLIER WITH STRAIGHT JAWS

- Model with cutter for hard wire (160 kg/mm²) and knurled gripping surface.

 PAGE 113



3060 PIPE WRENCH 90°

- Swedish pattern.
- 90° serrated jaw.

 PAGE 115



3004 HEAVY-DUTY DIAGONAL CUTTER

- Model with cutter for piano wire (200 kg/mm²).

 PAGE 113



3061 PIPE WRENCH 45°

- Swedish pattern.
- 45° serrated jaw.

 PAGE 115



3100 PLIER WITH STRAIGHT JAWS - INTERNAL CIRCLIPS

- PVC coated handles.

 PAGE 118



3110 PLIER WITH STRAIGHT JAWS - EXTERNAL CIRCLIPS

- PVC coated handles.

 PAGE 118



3115 PLIERS WITH NOSE BENT 90° - EXTERNAL CIRCLIPS

- PVC coated handles.

 PAGE 118



3200 LOCKING PLIER

- Model with curved jaws with cutter.

 PAGE 119



3400 METAL CUTTING SHEAR

- Internal torsion spring. Serrated edges prevent slipping.
- Cutting capacity: Stainless steel: 0,7 mm.

 PAGE 120



INSULATED PLIERS

POLAR® insulated pliers are individually tested to protect up to 1000V AC and VDE and GS approved.



3001 INSUL. COMBINATION PLIER

- Model with cutter for piano wire (200 kg/mm²) and knurled gripping surface.

 PAGE 116



3005 INSUL. HALF-ROUND LONG NOSE PLIERS WITH STRAIGHT JAWS

- Model with cutter for hard wire (160 kg/mm²) and knurled gripping surface.

 PAGE 116



3002 INSUL. DIAGONAL CUTTER

- Model with cutter for hard wire (160 kg/mm²).

 PAGE 116



3006 INSUL. HALF-ROUND NOSE PLIERS W/ BENT JAWS

- Model with cutter for hard wire (160 kg/mm²) and knurled gripping surface.

 PAGE 116



3004 INSUL. HEAVY-DUTY DIAGONAL CUTTER

- Model with cutter for piano wire (200 kg/mm²).

 PAGE 116



3009 INSUL. WIRE STRIPPER

- Model with opening spring and adjusting screw.

 PAGE 116



3020 INSUL. BOX-JOINT WATER PUMP PLIER

- Model with 7 positions and knurled gripping surface.

 PAGE 117





TOOL SETS

POLAR® offers a wide selection of different tool sets in sturdy water-resistant plastic cases - easy to carry around and always at hand.

5090 H 1/4" METRIC SOCKET WRENCH SET

- Socket wrench set with 6-point sockets from 4 to 14 mm and accessories.
- The set is supplied with a reversible 60-teeth ratchet with locking system.

 PAGE 9



5090 H 1/2" METRIC SOCKET WRENCH SET

- Socket wrench set with 6-point sockets from 10 to 32 mm and accessories.
- The set is supplied with a reversible 72-teeth ratchet with locking system.

 PAGE 17



5090 HL 3/8" METRIC SOCKET WRENCH SET

- Socket wrench set with 6-point sockets from 6 to 22 mm, long sockets from 8 to 22 mm and accessories.
- The set is supplied with a reversible 60-teeth ratchet with locking system.

 PAGE 16



5090 H 3/4" METRIC SOCKET WRENCH SET

- Socket wrench set with 6-point sockets from 22 to 50 mm and accessories.
- The set is supplied with a reversible 40-teeth ratchet.

 PAGE 18







SCREWDRIVERS & HEXAGON KEYS

POLAR® screwdrivers offer a great combination of power and comfort and the unique handle shape provides a soft and firm grip as well as superior force.



4000 SCREWDRIVERS FOR SLOTTED HEAD SCREWS

- Ergonomic soft grip handle.

 PAGE 124



4020 PZ SCREWDRIVERS FOR POZIDRIV® HEAD SCREWS

- Ergonomic soft grip handle.

 PAGE 126



4001 SCREWDRIVERS FOR SLOTTED HEAD SCREWS

- Supplied with go-through blade and hexagonal bolster.
- Ergonomic soft grip handle with impact cap.

 PAGE 124



4021 PZ SCREWDRIVERS FOR POZIDRIV® HEAD SCREWS

- Supplied with go-through blade and hexagonal bolster.
- Ergonomic soft grip handle with impact cap.

 PAGE 126

4003 STUBBY SCREWDRIVERS FOR SLOTTED HEAD SCREWS

- Ergonomic soft grip handle.

 PAGE 124



4200 INSULATED SCREWDRIVERS FOR SLOTTED HEAD SCREWS

- Every tool is individually tested to protect up to 1000V AC.
- Ergonomic soft grip handle.

 PAGE 131



4010 PH SCREWDRIVERS FOR PHILLIPS® HEAD SCREWS

- Ergonomic soft grip handle.

 PAGE 125



4210 INSULATED SCREWDRIVERS FOR PHILLIPS® HEAD SCREWS

- Every tool is individually tested to protect up to 1000V AC.
- Ergonomic soft grip handle.

 PAGE 131



4011 PH SCREWDRIVERS FOR PHILLIPS® HEAD SCREWS

- Supplied with go-through blade and hexagonal bolster.
- Ergonomic soft grip handle with impact cap.

 PAGE 125



4220 INSULATED SCREWDRIVERS FOR POZIDRIV® HEAD SCREWS

- Every tool is individually tested to protect up to 1000V AC.
- Ergonomic soft grip handle.

 PAGE 131

4013 PH STUBBY SCREWDRIVERS FOR PHILLIPS® HEAD SCREWS

- Ergonomic soft grip handle.

 PAGE 125





4290 INSULATED SCREWDRIVER SET - 6 PCS.

▪ Supplied in carton box.

 PAGE 132



4790 1/2" IMPACT BIT DRIVER SET

▪ Set supplied in plastic box with 5/16" bits (13 pcs.), bits socket and impact bit driver.

 PAGE 149



4195 LS/9 LONG METRIC HEXAGON KEY SET WITH BALL-POINT

▪ Supplied in plastic holder.

 PAGE 136



4195 FS/8 METRIC HEXAGON KEY SET WITH BALL-POINT

▪ Compact holder with comfortable grip.

 PAGE 137



4195 LIS/12 LONG INCH HEXAGON KEY SET WITH BALL-POINT

▪ Supplied in plastic holder.

 PAGE 136



4190 LTXS/9 LONG KEY SET FOR TORX® HEAD SCREWS

▪ Supplied in plastic holder.

 PAGE 136

4190 S/30 METRIC AND INCH HEXAGON KEY SET

▪ Supplied in plast box.

 PAGE 137



AIRTOOLS

POLAR® Air tools are designed to work comfortably and feature heavy duty components to resist the everyday use.



6100 C1 1/2" IMPACT WRENCH

- Composite motor housing.
- Lightweight.
- Twin hammer.

 PAGE 174



6120 A 5" ANGLE GRINDER

- Composite motor housing.
- Powerful 0,75 HP motor. Low noise level.

 PAGE 180



6100 D 3/4" IMPACT WRENCH

- Composite motor housing.
- Lightweight.
- Twin hammer.

 PAGE 176



6130 B DRILL, 13 MM

- Composite motor housing.
- Two speed trigger.

 PAGE 182



6110 A MINI GRINDER

- Comfort grip.
- Rotating rear regulator.

 PAGE 178



6137 B NEEDLE SCALER - PISTOL

 PAGE 183





HAMMERS & CHISELS

POLAR® offers a wide range of striking tools made of carbon steel and high grade chrome-molybdenum steel.



8010 BALL PEIN HAMMERS

- Model with round flat head and ball shaped pein.

PAGE 199



8040 SLEDGE HAMMERS

- Model with Hickory handle and steel protection.

PAGE 200

8290 PP/6 ASSORTMENT WITH 6 PIN PUNCHES

- Supplied in nylon bag.

PAGE 201



8290 S/5 ASSORTMENT WITH 5 TOOLS

- Taper, Center and Pin punch, Cape and Flat chisel.

PAGE 203



8200 PIN PUNCHES

PAGE 201



8205 TAPER PUNCHES

PAGE 202



8210 CENTER PUNCHES

PAGE 202



8215 CAPE CHISELS

PAGE 202



8220 FLAT CHISELS

PAGE 202



8290 S/17 ASSORTMENT WITH 17 TOOLS

- Taper, Center and Pin punch, Cape and Flat chisel.

PAGE 202



MISCELLANEOUS PRODUCTS

Discover a variety of POLAR® products including measuring tools, knives, saws and bench vises.



9101 UTILITY KNIFE

- Professional model with 9 mm snap-off blades.

PAGE 210

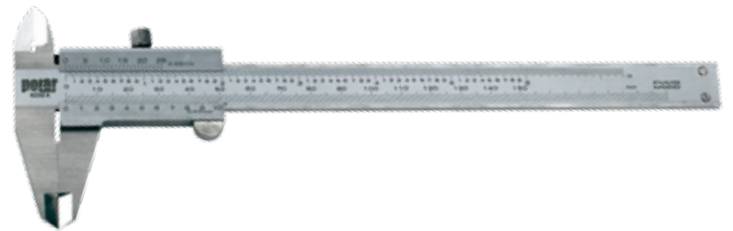

9200 A VERNIER CALIPER

- Accurate to 0.02 mm (1/50 mm). Inside, outside and depth measurements.

PAGE 212



9101 SB 9 MM SPARE BLADES (10 PCS.)

PAGE 210



9105 UTILITY KNIFE

- Professional model with 18 mm snap-off blades.

PAGE 210



9400 S TAPE RULES

- Precision class II. Casing in steel with rubbergrip.

PAGE 212



9105 SB 18 MM SPARE BLADES (10 PCS.)

PAGE 210



8400 BENCH VISES AND SWIVEL BASES

- Model made of cast carbon steel.

PAGE 206



9210 HACKSAW

- Model for 300 mm blades with possibility of positioning the blade at 45° and 90°.

PAGE 211



POLAR® TOOL INDEX



ROLLER CABINETS, ASSORTMENTS AND STORAGE 26-93

PAGE

ROLLER CABINETS 26-35

- EASY 28-29, 39
- X-LARGE 30-31
- CARGO 32-33
- MINI 34-35, 92

ROLLER CABINETS WITH TOOLS 46-59

- EASY 47-51
- X-LARGE 52-59
- MINI 46

TOOL ASSORTMENTS 44-87

- SINGLE ASSORTMENTS 60-76
- TOOL TRAY SYSTEM 44-45
- TRIPLE ASSORTMENTS 60-62, 69, 71, 73
- TOOLSET S1, 350 PCS. 77
- TOOLSET S2, 425 PCS. 78
- TOOLSET S3, 470 PCS. 80-81
- TOOLSET S4, 66 PCS. 82
- TOOLSET S5, 163 PCS. 83
- TOOLSET S6, 473 PCS. 84-85
- TOOLSET S7, 447 PCS. 87

STORAGE

- CABINETS 88, 91
- DRAWER CHESTS 36, 92
- SERVICE CART 92-93
- SIDE CABINETS 39
- TOOL BOX 36-38
- TOOL HOLDERS/HOOKS 88-90
- TOOL PANELS 88, 91
- WORKBENCH 91

ACCESSORIES 40

- DIVIDERS 41
- HOLDERS 40
- SIDETABLE 40
- SPAREPARTS 42-43
- WASTEBASKET 40



SOCKET WRENCH SETS AND TOOL SETS 6-25

PAGE

SOCKET SETS 8-19

- 1/4" 8-12
- 3/8" 13-16
- 1/2" 17
- 3/4" 18
- 1" 19

TOOL SETS 20-25



WRENCHES 94-102

PAGE

- ADJUSTABLE 102
- COMBINATION 95-96
- DOUBLE SOCKET RATCHET 98
- DOUBLE SWIVEL END 100
- FLARE NUT 100
- OFFSET 98
- OPEN END 97-98
- REVERSIBLE GEAR COMBINATION 97
- RING END 99
- SETS 95-102
- SWIVEL GEAR COMBINATION 101



AIR TOOLS 172-197

PAGE

- ACCESSORIES 182, 184-197
- BLOWGUNS 184
- DRILLS 182
- GRINDERS 178-180
- HAMMERS 183
- IMPACT WRENCHES 174-176
- NEEDLE SCALERS 183
- POLISHERS 180
- RATCHETS 177
- RIVETERS 182
- SANDERS 181
- TIRE INFLATING GUN 184

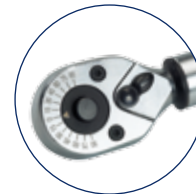

TORQUE WRENCHES 103-111

PAGE

- ANGLE AND TORQUE ADAPTERS 109
- ANGLE METER 110
- BICYCLE TORQUE KITS 108
- BOX END INSERTS 110
- CLICK-TYPE TORQUE WRENCHES 104-105
- DIGITAL TORQUE MINI WRENCHES 107
- DIGITAL TORQUE WRENCHES 106-107
- DIGITAL TORQUE SCREWDRIVERS 109
- OPEN END INSERTS 110-111
- RATCHET INSERTS 111



PLIERS 112-121

PAGE

PLIERS 112-120

- CIRCLIP 118
- COMBINATION 113
- DIAGONAL 113
- ELECTRONIC 114
- LOCKING 119-120
- NOSE 113
- PIPE WRENCHES 115
- TONGUE AND GROOVE 114
- SETS 115, 118
- WATER PUMP 114
- WIRE STRIPPER 113

PLIERS, INSULATED 116-117

- CABLE CUTTERS 117
- COMBINATION 116
- DIAGONAL 116
- NOSE 116
- SETS 117
- WIRE STRIPPER 116

MORE...

- ELECTRICIANS SCISSOR 120
- FILES 121
- METAL CUTTING SHEARS 120



MISCELLANEOUS PRODUCTS 204-215

PAGE

- BENCH VISES 206
- CABLE TIES 214
- INSPECTION MIRRORS 207-208
- KNIVES 210
- LEVELS 213
- MAGNETIC TRAYS 209
- OIL FILTER STRAP WRENCHES 205
- PICK-UP TOOLS 207-208
- SAWS (HAND- AND HACK SAW) 211
- SCRAPERS 205
- TAPE RULES 212-213
- UNIVERSAL PULLER 206
- VERNIER CALIPER 212
- WORK LAMP (LED) 215



SCREWDRIVERS AND BITS 122-149

PAGE

BITS AND ACCESSORIES 140-149

- 1/4" BITS 140-146
- 1/4" ADAPTERS 148
- 5/16" BITS 148-149
- BITS SETS 144-147
- SCREWDRIVER BIT SOCKETS 148-149

L-SHAPED KEYS 135-137

- HEXAGON KEYS 135-136
- TORX® 136
- SETS 136-137

SCREWDRIVERS 124-134

- DISPLAY SET 218
- FLEX 130
- GO-THROUGH 124-129
- HEX HEAD 130
- PHILLIPS® 125
- POZIDRIV® 126
- RATCHET SCREWDRIVER 133
- SETS 126-130
- SLOTTED 124
- TAMPER RESISTANT® 130
- TORX® 129

SCREWDRIVERS, INSULATED 131-132

- PHILLIPS® 131
- POZIDRIV® 131
- SETS 132
- SLOTTED 131
- VOLTAGE TESTER 131

SCREWDRIVERS, PRECISION 133-134

- PHILLIPS® 133
- SETS 134
- SLOTTED 133
- TAMPER RESISTANT® 133
- TORX® 133

SCREWDRIVERS, T-HANDLE 138-139

- HEX HEAD 138
- HEX NUTSPINNER 139
- TORX® 130



SOCKETS AND ACCESSORIES 150-171/185-197

PAGE

MANUEL

- 1/4" 152-155
- 3/8" 156-158
- 1/2" 159-169
- 3/4" 170
- 1" 171

IMPACT

- 3/8" 186-197
- 1/2" 188-193
- 3/4" 194-195
- 1" 196-197
- 1½" 197



STRIKING TOOLS 198-203

PAGE

- CHISELS 202-203
- HAMMERS 199-200
- PUNCHES 201-202
- SETS 201-203



DISPLAYS & COLLECTION 216-221

PAGE

- DISPLAY ACCESSORIES 216
- DISPLAY STAND 216
- DISPLAYS FOR TOOL SETS 217
- POLAR COLLECTION 219-221
- SALES DISPLAYS 217-218

POLAR TOOLS

WE ARE PROUD TO PRESENT OUR **NEW POLAR® CATALOGUE.**

POLAR TOOLS A/S is a Scandinavian manufacturer and supplier of professional quality tools. The company was established in 2006 with focus on global sales, creating strong and individual solutions to our global customers within various sectors – from the Army to the Pharmaceutical Industry, Offshore to Airlines, from Denmark to all over the world.

We have one single definition; to produce, sell and supply quality tools. **POLAR®** is good and solid handtools, which are characterized by reliability and design. **POLAR®** handtools follow the strict demands for quality and utility, though **POLAR®** handtools are sold at competitive prices.

At **POLAR®** we focus on offering an assortment which matches the present marked demands and expectations to a serious supplier of handtools. For this reason, all **POLAR®** handtools are carefully selected, examined and tested by professional users at our test centers.

Experience the wide range of products from **POLAR®**, which counts for more than 2,000 quality tools and still more to come.





POLARTOOLS.COM

Visit our up-to-date website for the latest product news and activities, and find all necessary technical information related to our products.

If you want to be sure not to miss important news, then sign up for our newsletter or join us on Facebook.



FIND US!

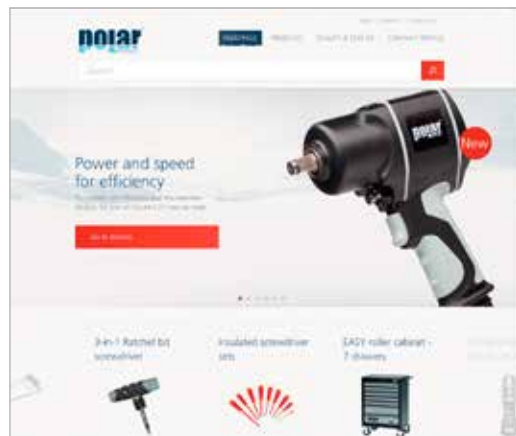

Products, News, Catalogues, Manuals and more.



Clearly sorted by range and size.



Product details, technical information and related products.

POLAR®
SOCKET WRENCH SETS AND TOOL SETS

SOCKET WRENCH SETS &

POLAR® offers a wide selection of different tool sets in sturdy water-resistant plastic cases and strong metal boxes.

Our plastic cases include a variety of features:

- Metal hinges
- Lockable with padlock
- Rubber gasket for water resistance
- Durable construction

Our metal boxes include following features:

- ABS trays
- Firm handle
- Strong metal hinges
- 1.2 mm strong steel casing
- Durable construction



TOOL SETS



POLAR® SOCKET WRENCH SETS AND TOOL SETS

SOCKET WRENCH SET

5090 HC 1/4" METRIC SOCKET WRENCH SET

ITEM NO. 50901423

- Socket wrench set supplied in compact plastic box with 6-point sockets from 4 to 13 mm, bits and accessories.
- The set is supplied with a reversible 72-teeth ratchet with locking system.
- 23 tools.

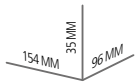

0,53 KG

5704196 014906

1

1/4"

1/4"

IMPA CODE 610107

CONTENT:

QTY.	DESCRIPTION	SIZE
12	6-point sockets	5014 1/4" 4 - 4.5 - 5 - 5.5 - 6 - 7 - 8 - 9 - 10 - 11 - 12 - 13 mm
2	Bits for Phillips® screws	4514 1/4" PH 1 - 2
2	Bits for Pozidriv® screws	4514 1/4" PZ 1 - 2
4	Bits for Torx® screws	4514 1/4" TX T15 - T20 - T25 - T30
1	Screwdriver bit socket	4714 1/4" x 1/4"
1	Wobble extension	5214 1/4" EXW 100 mm
1	Ratchet, 72 teeth	5314 C 1/4"

23
TOOLS





5090 H 1/4" METRIC SOCKET WRENCH SET

ITEM NO. 50901418

- Socket wrench set in watertight plastic case with 6-point sockets from 4 to 14 mm and accessories.
- The set is supplied with a reversible 60-teeth ratchet with locking system.
- 18 tools.



18
TOOLS

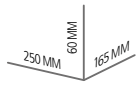

0,8 KG

5704196 000572

1

1/4"

IMPA CODE 610110



CONTENT:

QTY.	DESCRIPTION	SIZE
13	6-point sockets	5014 1/4" 4 - 4.5 - 5 - 5.5 - 6 - 7 - 8 - 9 - 10 - 11 - 12 - 13 - 14 mm
1	Ratchet, 60 teeth	5314 1/4" E
2	Extensions	5214 1/4" EX 50 - 100 mm
1	Sliding T-handle	5414 1/4" TH
1	Universal joint	5814 1/4" U



POLAR® SOCKET WRENCH SETS AND TOOL SETS

5090 HB 1/4" METRIC SOCKET WRENCH SET

ITEM NO. 50901441

- Socket wrench set in watertight plastic case with 6-point sockets from 4 to 14 mm, socket drivers and accessories.
- The set is supplied with a reversible 60-teeth ratchet with locking system.
- 41 tools.

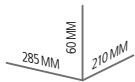

1,4 KG

5704196 000589

1

1/4"



41
TOOLS

CONTENT:

QTY.	DESCRIPTION	SIZE	QTY.	DESCRIPTION	SIZE
12	6-point sockets	5014 1/4" 4 - 5 - 5.5 - 6 - 7 - 8 - 9 - 10 - 11 - 12 - 13 - 14 mm	3	Socket drivers for Phillips® screws	5114 1/4" PH 1 - 2 - 3
1	Ratchet, 60 teeth	5314 1/4" E	3	Socket drivers for Pozidriv® screws	5114 1/4" PZ 1 - 2 - 3
2	Extensions	5214 1/4" EX 50 - 100 mm	8	Socket drivers for Tamper Resistant® Torx® screws	5114 1/4" STX T8 - T10 - T15 - T20 - T25 - T27 - T30 - T40
1	Sliding T-handle	5414 1/4" TH	6	Socket drivers for hex head screws	5114 1/4" H 3 - 4 - 5 - 6 - 8 - 10 mm
1	Universal joint	5814 1/4" U			
1	Plastic handle driver	5514 1/4" HD			
3	Socket drivers for slotted head screws	5114 1/4" 4 - 5.5 - 7 mm			



5090 HL 1/4" METRIC SOCKET WRENCH SET

ITEM NO. 50901459

- Socket wrench set in watertight plastic case with short and long 6-point sockets from 4 to 13 mm, bits and accessories.
- The set is supplied with a reversible 60-teeth ratchet with locking system.
- 59 tools.

59
TOOLS

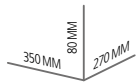

1,9 KG

5704196 000596

1

1/4"

1/4"



CONTENT:

QTY.	DESCRIPTION	SIZE	QTY.	DESCRIPTION	SIZE
11	6-point sockets	5014 1/4" 4 - 5 - 5.5 - 6 - 7 - 8 - 9 - 10 - 11 - 12 - 13 mm	1	Quick-Release screwdriver bit socket	4714 1/4" QR
10	Long 6-point sockets	5014 1/4" L 4 - 5 - 6 - 7 - 8 - 9 - 10 - 11 - 12 - 13 mm	5	Bits for slotted head screws	4514 1/4" 3.5 - 4.5 - 5.5 - 6.5 - 8 mm
1	Ratchet, 60 teeth	5314 1/4" E	3	Bits for Phillips® screws	4514 1/4" PH 1 - 2 - 3
2	Extensions	5214 1/4" EX 50 - 100 mm	3	Bits for Pozidriv® screws	4514 1/4" PZ 1 - 2 - 3
1	Sliding T-handle	5414 1/4" TH	10	Bits for Tamper Resistant® Torx® screws	4514 1/4" STX T7 - T8 - T9 - T10 - T15 - T20 - T25 - T27 - T30 - T40
1	Universal joint	5814 1/4" U	7	Bits for hex head screws	4514 1/4" H 2 - 3 - 4 - 5 - 6 - 7 - 8 mm
1	Plastic handle driver	5514 1/4" HD	2	Bits for square head screws	4514 1/4" SQ 1 - 2
1	Screwdriver bit socket	4714 1/4" x 1/4"			

POLAR® SOCKET WRENCH SETS AND TOOL SETS

5090 HIB 1/4" METRIC AND INCH SOCKET WRENCH SET

ITEM NO. 50901460

- Socket wrench set in watertight plastic case with 6-point sockets from 4 to 14 mm, 3/16" to 1/2", bits and accessories.
- The set is supplied with a reversible 60-teeth ratchet with locking system.
- 60 tools.

60
TOOLS

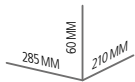

- 2,6 KG
- 5704196 000602
- 1
- 1/4"
- 1/4"
- IMPA CODE 610108



CONTENT:

QTY.	DESCRIPTION	SIZE	QTY.	DESCRIPTION	SIZE
12	6-point sockets	5014 1/4" 4 - 5 - 5.5 - 6 - 7 - 8 - 9 - 10 - 11 - 12 - 13 - 14 mm	1	Quick-Release screwdriver bit socket	4714 1/4" QR
9	6-point sockets	5014 1/4" 3/16 - 7/32 - 1/4 - 9/32 - 5/16 - 11/32 - 3/8 - 7/16 - 1/2"	5	Bits for slotted head screws	4514 1/4" 3.5 - 4.5 - 5.5 - 6.5 - 8 mm
1	Ratchet, 60 teeth	5314 1/4" A	3	Bits for Phillips® screws	4514 1/4" PH 1 - 2 - 3
2	Extensions	5214 1/4" EX 50 - 100 mm	3	Bits for Pozidriv® screws	4514 1/4" PZ 1 - 2 - 3
1	Flexible extension	5214 1/4" F	10	Bits for Tamper Resistant® Torx® screws	4514 1/4" STX T7 - T8 - T9 - T10 - T15 - T20 - T25 - T27 - T30 - T40
1	Sliding T-handle	5414 1/4" TH	7	Bits for hex head screws	4514 1/4" H 2 - 3 - 4 - 5 - 6 - 7 - 8 mm
1	Universal joint	5814 1/4" U	2	Bits for square head screws	4514 1/4" SQ 1 - 2
1	Plastic handle driver	5514 1/4" HD			
1	Screwdriver bit socket	4714 1/4" x 1/4"			



5090 H 3/8" METRIC SOCKET WRENCH SET

ITEM NO. 50903812

- Socket wrench set in metal box with 6-point sockets from 7 to 19 mm and accessories.
- The set is supplied with a reversible 60-teeth ratchet with locking system.
- 12 tools.

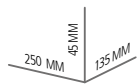

- 1,7 KG
- 5704196 018485
- 1
- 3/8"



CONTENT:

QTY.	DESCRIPTION	SIZE
9	6-point sockets	5038 3/8" 6 - 7 - 8 - 9 - 10 - 11 - 12 - 13 - 14 - 15 - 16 mm
1	Ratchet, 60 teeth	5338 3/8" E
1	Extension	5238 3/8" EX 150 mm
1	Sliding T-handle	5438 3/8" TH



POLAR® SOCKET WRENCH SETS AND TOOL SETS

5090 HLM 3/8" METRIC SOCKET WRENCH SET

ITEM NO. 5090-3832

- Socket wrench set in metal box with 17 6-point sockets from 6 to 24 mm and 10 long 6-point sockets from 6 to 19 mm and accessories.
- Supplied with a reversible 60-teeth ratchet.

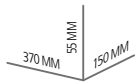

3,6 KG

5704196 028811

1

3/8"

32
TOOLS



CONTENT:

QTY.	DESCRIPTION	SIZE
17	6-point sockets	5038 3/8" 6-7-8-9-10-11-12-13-14-15-16-17-18-19-21-22-24mm
10	Long 6-point sockets	5038 3/8" L 6-7-8-10-11-13-16-17-18-19 mm
2	Extensions	5238 3/8" EX 75-150mm
1	Ratchet, 60 teeth	5338 3/8" E
1	Sliding T-handle	5938 3/8" FH 250 mm
1	Universal joint	5838 3/8" U





5090 HB 3/8" METRIC SOCKET WRENCH SET

ITEM NO. 5090-3847

- Socket wrench set in metal box with 17 6-point sockets from 6 to 24 mm and 7 NTX Torx® sockets from 6 to 16 mm, bits and accessories.
- Supplied with a reversible 60-teeth ratchet.

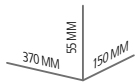

3,4 KG

5704196 028828

1

3/8"

47 TOOLS



CONTENT:

QTY.	DESCRIPTION	SIZE
17	6-point sockets	5038 3/8" 6-7-8-9-10-11-12-13-14-15-16-17-18-19-21-22-24mm
7	Sockets, Torx® screws	5038 3/8" NTX E6 - E7 - E8 - E10 - E12 - E14 - E16
2	Extensions	5238 3/8" EX 75 - 150mm
1	Ratchet, 60 teeth	5338 3/8" E
1	Sliding T-handle	5938 3/8" FH 250mm
1	Universal joint	5838 3/8" U
8	Bits, slotted head screws	4516 5/16" 2 - 2,5 - 3 - 4 - 5 - 6 - 8 - 10
9	Bits, Torx® screws	4516 5/16" TX T10 - T15 - T20 - T25 - T30 - T40 - T45 - T50 - T55
1	Screwdriver bit socket, 5/16" bits	4738 5/16"



POLAR® SOCKET WRENCH SETS AND TOOL SETS

5090 HL 3/8" METRIC SOCKET WRENCH SET

ITEM NO. 50903836

- Socket wrench set in watertight plastic case with 6-point sockets from 6 to 22 mm, long sockets from 8 to 22 mm and accessories.
- The set is supplied with a reversible 60-teeth ratchet with locking system.
- 36 tools.



36
TOOLS

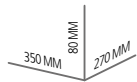

 3,4 KG

 5704196 000619

 1

 3/8"

 3/8"

IMPA CODE 610114



CONTENT:

QTY.	DESCRIPTION	SIZE
17	6-point sockets	5038 3/8" 6 - 7 - 8 - 9 - 10 - 11 - 12 - 13 - 14 - 15 - 16 - 17 - 18 - 19 - 20 - 21 - 22 mm
12	Long 6-point sockets	5038 3/8" L 8 - 9 - 10 - 11 - 12 - 13 - 14 - 15 - 17 - 19 - 20 - 22 mm
1	Ratchet, 60 teeth	5338 3/8" E
1	Extension	5238 3/8" EX 150 mm
1	Sliding T-handle	5438 3/8" TH
1	Universal joint	5838 3/8" U
3	Spark plug sockets	5038 3/8" SP 16 - 18 - 21 mm



5090 H 1/2" METRIC SOCKET WRENCH SET

ITEM NO. 50901223

- Socket wrench set in watertight plastic case with 6-point sockets from 10 to 32 mm and accessories.
- The set is supplied with a reversible 60-teeth ratchet with locking system.
- 23 tools.

23 TOOLS

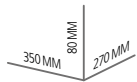

4,1 KG

5704196 000626

1

1/2"

IMPA CODE 610142



CONTENT:

QTY.	DESCRIPTION	SIZE
18	6-point sockets	5012 1/2" 10 - 11 - 12 - 13 - 14 - 15 - 16 - 17 - 18 - 19 - 20 - 21 - 22 - 23 - 24 - 27 - 30 - 32 mm
1	Ratchet, 60-teeth	5312 1/2" E
2	Extensions	5212 1/2" EX 125, 250 mm
1	Sliding T-handle	5412 1/2" TH
1	Universal joint	5812 1/2" U



POLAR® SOCKET WRENCH SETS AND TOOL SETS

5090 H 3/4" METRIC SOCKET WRENCH SET

ITEM NO. 50903415

- Socket wrench set in plastic case with 6-point sockets from 22 to 50 mm and accessories.
- The set is supplied with a reversible 48-teeth ratchet.
- 14 tools.

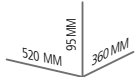

13 KG

5704196 000633 **IMPA CODE** 610153

1

3/4"

CONTENT:

QTY.	DESCRIPTION	SIZE
10	6-point sockets	5034 3/4" 22 - 24 - 27 - 30 - 32 - 36 - 38 - 41 - 46 - 50 mm
1	Ratchet, 48 teeth	5334 3/4"
2	Extensions	5234 3/4" EX 100 - 200 mm
1	Sliding T-handle	5434 3/4" TH



14
TOOLS



5090 H 1" METRIC SOCKET WRENCH SET

ITEM NO. 50900115

- Socket wrench set in metal box with 6-point sockets from 36 to 80 mm and accessories.
- Supplied with a reversible 24-teeth ratchet.
- 15 tools.

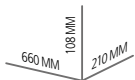

27,6 KG

5704196 026572

1

1"

CONTENT:

QTY.	DESCRIPTION	SIZE
10	6-point sockets	5001 1" 36 - 41 - 46 - 50 - 55 - 60 - 65 - 70 - 75 - 80 mm
1	Ratchet, 24 teeth	5301 1"
2	Extensions	5201 1" EX 200 - 400 mm
1	Handle	550 mm
1	Sliding head	1"



15
TOOLS

POLAR® SOCKET WRENCH SETS AND TOOL SETS



5191 A 1/4" AND 3/8" METRIC TOOL SET

ITEM NO. 51911098

- Socket wrench set in watertight plastic case with short and long 6-point sockets, bits, combination wrenches, screwdrivers, adjustable wrench, pliers, hammer and accessories.
- The set is supplied with reversible ratchets with locking system.
- 98 tools.

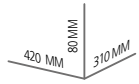

6,0 KG

5704196 000664

1

1/4" 3/8"

1/4"

98
TOOLS



CONTENT:

QTY.	DESCRIPTION	SIZE	QTY.	DESCRIPTION	SIZE
12	6-point sockets	5014 1/4" 4 - 4.5 - 5 - 5.5 - 6 - 7 - 8 - 9 - 10 - 11 - 12 - 13 mm	5	Bits for slotted head screws	4514 1/4" 3.5 - 4.5 - 5.5 - 6.5 - 8 mm
10	Long 6-point sockets	5014 1/4" L 4 - 5 - 6 - 7 - 8 - 9 - 10 - 11 - 12 - 13 mm	3	Bits for Phillips® screws	4514 1/4" PH 1 - 2 - 3
12	6-point sockets	5038 3/8" 10 - 11 - 12 - 13 - 14 - 15 - 16 - 17 - 18 - 19 - 20 - 22 mm	3	Bits for Pozidriv® screws	4514 1/4" PZ 1 - 2 - 3
2	Spark plug sockets	5038 3/8" SP 18 - 21 mm	10	Bits for Tamper Resistant® Torx® screws	4514 1/4" STX T7 - T8 - T9 - T10 - T15 - T20 - T25 - T27 - T30 - T40
1	Ratchet, 60 teeth	5314 1/4" E	7	Bits for hex head screws	4514 1/4" H 2 - 3 - 4 - 5 - 6 - 7 - 8 mm
1	Ratchet, 60 teeth	5338 3/8" E	2	Bits for square head screws	4514 1/4" SQ 1 - 2
2	Extensions	5214 1/4" EX 50 - 100 mm	1	Screwdriver for slotted head screws	4000 5,5 x 125 mm
2	Extensions	5238 3/8" EX 150 - 250 mm	1	Screwdriver for Phillips® screws	4010 PH 2
1	Sliding T-handle	5414 1/4" TH	1	Screwdriver for Pozidriv® screws	4020 PZ 2
1	Universal joint	5814 1/4" U	13	Combination wrenches	2000 7 - 8 - 9 - 10 - 11 - 12 - 13 - 14 - 15 - 16 - 17 - 18 - 19 mm
1	Universal joint	5838 3/8" U	1	Adjustable wrench	2605 150 mm / 8"
1	Plastic handle driver	5514 1/4" HD	1	Combination plier	3001 180 mm
1	Screwdriver bit socket	4714 1/4" x 1/4"	1	Waterpump plier	3020 250 mm
1	Quick-Release screwdriver bit socket	4714 1/4" QR	1	Engineers hammer	8030 300 g

POLAR® SOCKET WRENCH SETS AND TOOL SETS

5191 D 1/4" AND 1/2" METRIC SOCKET SET

ITEM NO. 51910094

- Socket wrench set in watertight plastic case with short and long 6-point sockets, bits, bits sockets and accessories.
- The set is supplied with reversible ratchets with locking system.
- 94 tools.

94
TOOLS

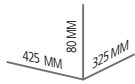

6,5 KG

5704196 031651

1

1/4" 1/2"

1/4"



CONTENT:

QTY.	DESCRIPTION	SIZE	QTY.	DESCRIPTION	SIZE
13	6-point sockets	5014 1/4" 4 - 4.5 - 5 - 5.5 - 6 - 7 - 8 - 9 - 10 - 11 - 12 - 13 - 14 mm	18	6-point sockets	5012 1/2" 10 - 11 - 12 - 13 - 14 - 15 - 16 - 17 - 18 - 19 - 20 - 21 - 22 - 23 - 24 - 27 - 30 - 32 mm
8	Long 6-point sockets	5014 1/4" L 6 - 7 - 8 - 9 - 10 - 11 - 12 - 13 mm	4	Long 6-point sockets	5012 1/2" L 14 - 15 - 17 - 19 mm
6	Socket drivers for Torx® screws	5114 1/4" TX T8 - 10 - 15 - 20 - 25 - 30	2	Extensions	5212 1/2" EX 125 - 250 mm
3	Socket drivers for slotted screws	5114 1/4" 4 - 5.5 - 7 mm	1	Universal joint	5812 1/2" U
4	Socket drivers for hex head screws	5114 1/4" H 3 - 4 - 5 - 6 mm	1	Screwdriver bit socket	4712 1/2"
2	Socket drivers for Pozidriv® screws	5114 1/4" PZ 1 - 2	2	Spark Plug Sockets	5012 1/2" SP 16 - 21 mm
2	Socket drivers for Phillips® screws	5114 1/4" PH 1 - 2	1	Adaptor	5638 A 3/8" to 1/2"
2	Extensions	5214 1/4" EX 50, 100 mm,	1	Ratchet, 60 teeth	5312 1/2" E
1	Universal joint	5814 1/4" U	4	Bits for Torx® screws	4514 1/4" TX T40 - 45 - 50 - 55
1	Sliding T-handle	5414 1/4" TH	3	Bits for slotted screws	4514 1/4" 8 - 10 - 12 mm
1	Plastic handle driver	5514 1/4" HD	4	Bits for hex head screws	4514 1/4" H 8 - 10 - 12 - 14 mm
1	Flexible extension	5214 1/4" F 150 mm	2	Bits for Phillips® screws	4514 1/4" PH 3 - 4
1	Ratchet, 60 teeth	5314 1/4" E	2	Bits for Pozidriv® screws	4514 1/4" PZ 3 - 4
			1	Bits Adaptor	4714 1/4" SQ
			3	Hex keys	4100 1.5 - 2 - 2.5 mm

POLAR® SOCKET WRENCH SETS AND TOOL SETS



5191 B 1/4" AND 1/2" METRIC TOOL SET

ITEM NO. 51910098

- Socket wrench set in watertight plastic case with short and long 6-point sockets, bits, combination wrenches, double swivel end socket wrenches and accessories.
- The set is supplied with reversible ratchets with locking system.
- 98 tools.

98
TOOLS

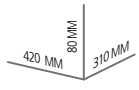

7,2 KG

5704196 000640

1

1/4" 1/2"

1/4" 5/16"



CONTENT:

QTY.	DESCRIPTION	SIZE	QTY.	DESCRIPTION	SIZE
12	6-point sockets	5014 1/4" 4 - 4.5 - 5 - 5.5 - 6 - 7 - 8 - 9 - 10 - 11 - 12 - 13 mm	1	Quick-Release screwdriver bit socket	4714 1/4" QR
10	Long 6-point sockets	5014 1/4" L 4 - 5 - 6 - 7 - 8 - 9 - 10 - 11 - 12 - 13 mm	1	Socket adaptor	4714 1/4" SQ 25 mm
13	6-point sockets	5012 1/2" 10 - 11 - 12 - 13 - 14 - 15 - 17 - 19 - 22 - 24 - 27 - 30 - 32 mm	5	Bits for slotted head screws	4514 1/4" 3.5 - 4.5 - 5.5 - 6.5 - 8 mm
1	Ratchet, 60 teeth	5314 1/4" E	3	Bits for Phillips® screws	4514 1/4" PH 1 - 2 - 3
1	Ratchet, 60 teeth	5312 1/2" E	3	Bits for Pozidriv® screws	4514 1/4" PZ 1 - 2 - 3
2	Extensions	5214 1/4" EX 50 - 100 mm	10	Bits for Tamper Resistant® Torx® screws	4514 1/4" STX T7 - T8 - T9 - T10 - T15 - T20 - T25 - T27 - T30 - T40
2	Extensions	5212 1/2" EX 125 - 250 mm	4	Bits for Torx® screws	4516 5/16" TX T40 - T45 - T50 - T55
1	Flexible handle	5912 1/2" FH 410 mm	7	Bits for hex head screws	4514 1/4" H 2 - 3 - 4 - 5 - 6 - 7 - 8 mm
1	Sliding T-handle	5414 1/4" TH	2	Bits for square head screws	4514 1/4" SQ 1 - 2
1	Sliding T-handle	5412 1/2" TH	6	Combination wrenches	2000 8 - 10 - 12 - 13 - 14 - 17 mm
1	Universal joint	5814 1/4" U	4	Double swivel end socket wrenches	2400 8 x 9 - 10 x 11 - 12 x 13 - 14 x 15 mm
1	Universal joint	5812 1/2" U	3	Hexagon keys	4100 1.5 - 2 - 2.5 mm
1	Plastic handle driver	5514 1/4" HD			
1	Screwdriver bit socket	4714 1/4" x 1/4"			
1	Screwdriver bit socket	4712 1/2" x 5/16"			

POLAR® SOCKET WRENCH SETS AND TOOL SETS

5191 C 1/4", 3/8" AND 1/2" METRIC TOOLSET

ITEM NO. 51910147

- Socket wrench set in watertight plastic case with short and long 6-point sockets, bits, combination wrenches, adjustable wrench, double swivel end socket wrenches, pliers, hammer and accessories.
- Supplied with reversible ratchets with locking system.
- 147 tools.

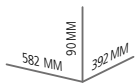

12,6 KG

5704196 000657

1

1/4" 3/8" 1/2"

1/4" 5/16"



147
TOOLS

CONTENT:

QTY.	DESCRIPTION	SIZE	QTY.	DESCRIPTION	SIZE
13	6-point sockets	5014 1/4" 4 - 4.5 - 5 - 5.5 - 6 - 7 - 8 - 9 - 10 - 11 - 12 - 13 - 14 mm	1	Screwdriver bit socket	4714 1/4" x 1/4"
10	Long 6-point sockets	5014 1/4" L4 - 5 - 6 - 7 - 8 - 9 - 10 - 11 - 12 - 13 mm	1	Screwdriver bit socket	4712 1/2" x 5/16"
6	6-point sockets	5038 3/8" 10 - 13 - 16 - 17 - 18 - 19 mm	1	Socket adaptor	4714 1/4" SQ 25 mm
13	6-point sockets	5012 1/2" 10 - 11 - 12 - 13 - 14 - 15 - 17 - 19 - 22 - 24 - 27 - 30 - 32 mm	1	Socket adaptor	4716 3/8" SQ 25 mm
4	Sockets for Torx® screws	5014 1/4" NTX E4 - E5 - E6 - E7	1	Quick-Release screwdriver bit socket	4714 1/4" QR
7	Sockets for Torx® screws	5038 3/8" NTX E8 - E10 - E11 - E12 - E14 - E16 - E18	5	Bits for slotted head screws	4514 1/4" 3.5 - 4.5 - 5.5 - 6.5 - 8 mm
3	Spark plug sockets	5038 3/8" SP 16 - 18 - 21 mm	2	Bits for slotted head screws	4516 5/16" 10 - 12 mm
3	Long thinwalled 6-point sockets	6012 1/2" LT 17 - 19 - 21 mm	3	Bits for Phillips® screws	4514 1/4" PH 1 - 2 - 3
1	Ratchet, 60 teeth	5314 1/4" E	1	Bits for Phillips® screws	4516 5/16" PH 4
1	Ratchet, 60 teeth	5338 3/8" E	3	Bits for Pozidriv® screws	4514 1/4" PZ 1 - 2 - 3
1	Ratchet, 60 teeth	5312 1/2" E	1	Bits for Pozidriv® screws	4516 5/16" PZ 4
2	Extensions	5214 1/4" EX 50 - 100 mm	10	Bits for Tamper Resistant® Torx® screws	4514 1/4" STX T7 - T8 - T9 - T10 - T15 - T20 - T25 - T27 - T30 - T40
1	Extension	5238 3/8" EX 125 mm	4	Bits for Torx® screws	4516 5/16" TX T40 - T45 - T50 - T55
2	Extensions	5212 1/2" EX 125 - 250 mm	7	Bits for hex head screws	4514 1/4" H 2 - 3 - 4 - 5 - 6 - 7 - 8 mm
1	Flexible extension	5214 1/4" F	2	Bits for hex head screws	4516 5/16" H 10 - 12 mm
1	Flexible handle	5912 1/2" FH 410 mm	2	Bits for square head screws	4514 1/4" SQ 1 - 2
1	Sliding T-handle	5414 1/4" TH	13	Combination wrenches	2000 7 - 8 - 9 - 10 - 11 - 12 - 13 - 14 - 15 - 16 - 17 - 18 - 19 mm
1	Sliding T-handle	5438 3/8" TH	4	Double swivel end socket wrenches	2400 8 x 9 - 10 x 11 - 12 x 13 - 14 x 15 mm
1	Sliding T-handle	5412 1/2" TH	3	Metric hexagon keys	4100 1.5 - 2 - 2.5 mm
1	Universal joint	5814 1/4" U	1	Adjustable wrench	2605 250 mm / 10"
1	Universal joint	5838 3/8" U	1	Combination plier	3001 180 mm
1	Universal joint	5812 1/2" U	1	Waterpump plier	3020 250 mm
1	Plastic handle driver	5514 1/4" HD	1	Engineers hammer	8030 300 g
1	Adaptor	5738 3/8" A			
1	Adaptor	5712 1/2" A			

POLAR® SOCKET WRENCH SETS AND TOOL SETS



1092 A2 TOOL BOX WITH TOOL ASSORTMENT

5704196 018508 HxWxD 240 x 495 x 225 mm 17 KG 1

- TOOL BOX with tool set type 1875 S4.
- 2 drawers mounted on ball bearing slides.
- All drawers are supplied with oil-proff rubber mats.
- Centralized locking.
- 66 tools.

66
TOOLS



CONTENT S4 TOOL SET - 66 TOOLS:



QTY.	DESCRIPTION	SIZE
18	6-point sockets	5012 1/2" 10-11-12-13-14-15-16-17-18-19-20-21-22-23-24-27-30-32 mm
1	Ratchet, 60 teeth	5312 1/2" E
2	Extensions	5212 1/2" EX 125 - 250 mm
1	Sliding T-handle	5412 1/2" TH
1	Universal joint	5812 1/2" U
4	Screwdrivers for slotted head screws	4000 3 x 75 - 4 x 100 - 5,5 x 125 - 6,5 x 150 mm
3	Screwdrivers for Phillips® screws	4010 PH 1 - PH 2 - PH 3
14	Combination wrenches	2000 8 - 9 - 10 - 11 - 12 - 13 - 14 - 15 - 16 - 17 - 18 - 19 - 21 - 22 mm
1	Combination plier	3001 180 mm
1	Diagonal cutter	3002 160 mm
1	Half-round long nose plier	3005 160 mm

QTY.	DESCRIPTION	SIZE
1	Waterpump plier	3020 250 mm
1	Locking plier	3202 250 mm
1	Electricians scissor	3500 140 mm
9	Long metric hexagon keys	4105 BP 1.5 - 2 - 2.5 - 3 - 4 - 5 - 6 - 8 - 10 mm
1	Mechanics hammer	8030 300 g
1	Taper punch	8205 3 x 120 mm
1	Center punch	8210 2 x 120 mm
1	Cape chisel	8215 5 x 130 mm
1	Flat chisel	8220 12 x 130 mm
1	Pin punch	8200 4 x 150 mm
1	Hacksaw	9210 300 mm

POLAR® SOCKET WRENCH SETS AND TOOL SETS

1092 3D TOOL BOX WITH TOOL ASSORTMENT

ITEM NO. 10920119

- TOOL BOX with tool set type 1875 S10.
- 3 drawers mounted on ball bearing slides.
- All drawers are supplied with oil-proff rubber mats.
- 119 tools.

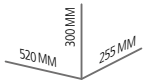

5704196 027678 20 KG



119
TOOLS



CONTENT TRAY:



QTY.	DESCRIPTION	SIZE
12	6-point sockets	5014 1/4" 4- 4.5- 5- 5.5- 6- 7- 8- 9- 10- 11- 12- 13 mm
3	Long 6-point sockets	5014 1/4" L 8- 10- 13 mm
1	Universal joint	5814 1/4" U
1	Extension	5214 1/4" EX 50 mm
1	Ratchet, 60-teeth	5314 1/4" E
1	Sliding T-handle	5414 TH 1/4"
1	Spinner handle	5514 1/4" HD
1	Magnetic Bit Holding Screwdriver	4043 M 1/4" x 100 mm

QTY.	DESCRIPTION	SIZE
14	6-point sockets	5012 1/2" 14- 15- 16- 17- 18- 19- 20- 21- 22- 23- 24- 27- 30- 32 mm
3	Long 6-point sockets	5012 1/2" L 17, 19, 21 mm
1	Universal joint	5812 1/2" U
3	Extensions	5212 1/2" EX 50 - 125 - 150 mm
1	Ratchet, 60-teeth	5312 E 1/2"
1	Bits set with bit holder, 32 tools	4590 H 1/4"

CONTENT DRAWERS:



QTY.	DESCRIPTION	SIZE
3	Screwdrivers for Philips® screws	4010 PH 1 - PH 2 - PH 3
1	Stubby screwdriver for Philips® screws	4013 PH 1
4	Screwdrivers for slotted screws	4000 4x100 - 5.5x125 - 6.5x150 - 8x175 mm
1	Stubby screwdriver for slotted screws	4003 5.5x25 mm



QTY.	DESCRIPTION	SIZE
11	Combination wrenches	2000 8-10-11-12-13-14-15-16-17-18-19 mm
1	Long metric hexagon key set with ball-point	4195 LS/9 1.5- 2- 2.5- 3- 4- 5- 6- 8- 10 mm
1	Long key set for Torx® Key Set	4190 LTXS/9 T8-T10-T15-T20-T25-T27-T30-T40-T50



QTY.	DESCRIPTION	SIZE
1	Water pump plier	3020 250 mm
1	Half-round long nose plier straight jaw	3005 200 mm
1	Combination plier	3001 180 mm
1	Heavy-duty diagonal cutter	3004 180 mm
1	Mechanic hammer	8030 300 g
1	Adjustable wrench	2600 8"/200 mm

POLAR® SOCKET WRENCH SETS AND TOOL SETS



1093 5T CANTILEVER TOOL BOX WITH TOOL ASSORTMENT

ITEM NO. 10930104

- TOOL BOX with tool set type 1875 S9.
- Preset for padlock.
- 104 tools.

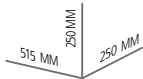

11,9 KG

5704196 027685



CONTENT TRAYS:



QTY.	DESCRIPTION	SIZE
11	6-point sockets	5014 1/4" 3.5 - 4 - 5 - 6 - 7 - 8 - 9 - 10 - 11 - 12 - 13 mm
1	Universal joint	5814 1/4" U
1	Extension	5214 1/4" EX 50 mm
1	Ratchet, 60-teeth	5314 1/4" E
1	Water Pump Plier	3020 250 mm
1	Adjustable wrench	2600 8"/200 mm



QTY.	DESCRIPTION	SIZE
10	Combination wrenches	2000 8 - 9 - 10 - 11 - 12 - 13 - 14 - 15 - 17 - 19 mm
1	Mechanic hammer	8030 300 g
1	Combination plier	3001 180 mm
1	Half-round long nose plier with straight jaw	3005 200 mm
1	Measuring tape	9400 3 mtr.



QTY.	DESCRIPTION	SIZE
2	Screwdrivers for slotted screws	4000 3 x 75 - 5.5 x 125
2	Screwdrivers for Philips® screws	4010 PH 1 - PH 2
1	Magnetic bit holding screwdriver	4043 M 1/4" x 100 mm
1	Bits set with bit holder, 32 tools	4590 H 1/4"



QTY.	DESCRIPTION	SIZE
14	6-point sockets	5012 1/2" 10 - 13 - 14 - 15 - 16 - 17 - 18 - 19 - 21 - 22 - 24 - 27 - 30 - 32 mm
1	Universal joint	5812 1/2" U
1	Extension	5212 1/2" EX 125 mm
1	Ratchet, 60-teeth	5312 1/2" E



QTY.	DESCRIPTION	SIZE
1	Long key set for Torx® Key Set	4190 LTXS/9 T8-T10-T15-T20-T25-T27-T30-T40-T50
1	Long metric hexagon key set with ball-point	4195 LS/9 1.5-2-2.5-3-4-5-6-8-10 mm
1	Pin punch	8200 3 mm
1	Center punch	8210 4 mm

POLAR®
 ROLLER CABINETS, ASSORTMENTS AND STORAGE

ROLLER CABINETS

POLAR® Roller cabinets have been developed and built to exceed the highest standards. The construction of our tool storage units are performed without compromise, to ensure the strength and durability you need.

All our Roller cabinets includes the following standard features:

- Quick lock system
- Centralized locking
- Drawer with steel handles
- Double wall construction
- Reinforced corner gussets
- 1.2 mm strong sheet steel casing
- Worktop in chemical resistant hard PVC material
- Oil-proof rubber mats in all drawers
- Large oil-proof rubber casters





POLAR®
 ROLLER CABINETS, ASSORTMENTS AND STORAGE

ROLLER CABINETS

EASY

POLAR® EASY is our most popular roller cabinet, which gives you reliability and space, to store your tools and equipment. A large program of side cabinets and accessories makes this roller cabinet very versatile.

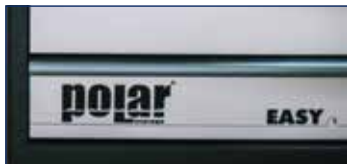

POLAR® ROLLER CABINETS, ASSORTMENTS AND STORAGE

TROLLEY DIMENSIONS

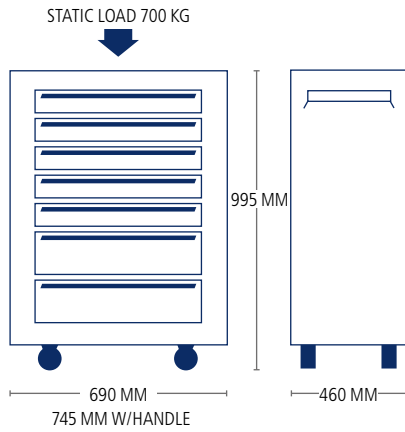

DRAWER DIMENSIONS

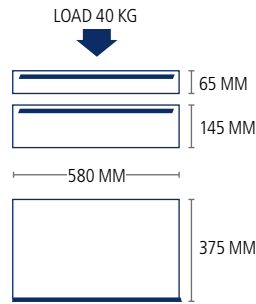

EASY TOOLSETS

163 tools - page 47
350 tools - page 48-49
425 tools - page 50-51

EASY ACCESSORIES

Page 40-41

EASY SPAREPARTS

Page 42-43

1000 7D EASY ROLLER CABINET (EMPTY)

ITEM NO. 1000007



- Empty trolley with 7 drawers.
- 5 drawers: H 65 x W 580 x D 375 mm
- 2 drawers: H 145 x W 580 x D 375 mm
- Heavy-duty construction: 700 kg static load.
- Drawer loading capacity: 40 kg

1000 8D EASY ROLLER CABINET (EMPTY)

ITEM NO. 1000008



- Empty trolley with 8 drawers.
- 7 drawers: H 65 x W 580 x D 375 mm
- 1 drawers: H 145 x W 580 x D 375 mm
- Heavy-duty construction: 700 kg static load.
- Drawer loading capacity: 40 kg

POLAR®
 ROLLER CABINETS, ASSORTMENTS AND STORAGE

X-LARGE

POLAR® X-LARGE gives you 50 % more storage capacity for your tools and equipment. The large worktop makes it a good workstation, whenever mobility is needed. The roller cabinet is available with 7 and 8 drawers.





TROLLEY DIMENSIONS

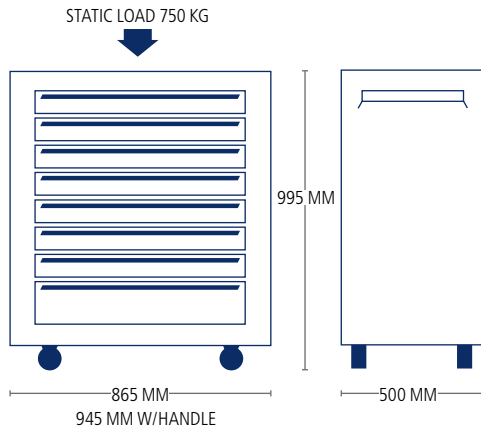

DRAWER DIMENSIONS

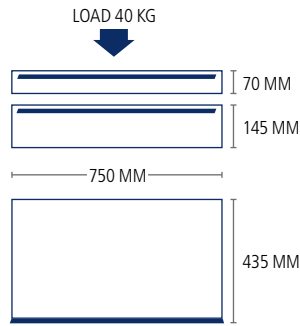

X-LARGE TOOLSETS

350 tools - page 52-53
447 tools - page 54-55
470 tools - page 56-57
473 tools - page 58-59

X-LARGE ACCESSORIES

Page 40-41

X-LARGE SPAREPARTS

Page 42-43

1000 7D X-LARGE ROLLER CABINET (EMPTY)

ITEM NO. 10001007

84,5 KG 5704196 013510

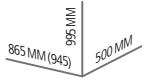

- Empty trolley with 7 drawers.
- 5 drawers: H 70 x W 750 x D 435 mm.
- 2 drawers: H 145 x W 750 x D 435 mm
- Heavy-duty construction: 750 kg static load.
- Drawer loading capacity: 40 kg

1000 8D X-LARGE ROLLER CABINET (EMPTY)

ITEM NO. 10001008

85 KG 5704196 015668

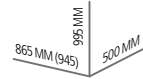

- Empty trolley with 8 drawers.
- 7 drawers: H 70 x W 750 x D 435 mm.
- 1 drawer: H 145 x W 750 x D 435 mm
- Heavy-duty construction: 750 kg static load.
- Drawer loading capacity: 40 kg

POLAR®
 ROLLER CABINETS, ASSORTMENTS AND STORAGE

CARGO

POLAR® CARGO is our largest roller cabinet and preferable when storage space and mobility is the key word. Adding side cabinets and accessories, will make this roller cabinet very versatile and a true workstation.





TROLLEY DIMENSIONS

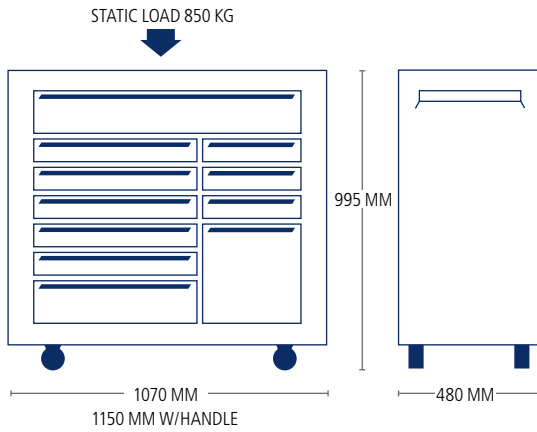

DRAWER DIMENSIONS

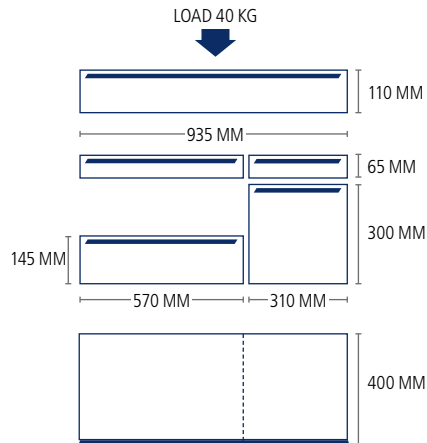

CARGO TOOLSETS

163 tools - page 83
350 tools - page 77

CARGO ACCESSORIES

Page 40-41

CARGO SPAREPARTS

Page 42-43

1000 11D CARGO ROLLER CABINET (EMPTY)

ITEM NO. 10002011

127 KG

5704196 013527

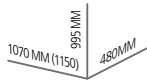

- Empty trolley with 11 drawers.
- 1 drawer: H 110 x W 935 x D 400 mm
- 5 drawers: H 65 x W 570 x D 400 mm
- 1 drawer: H 145 x W 570 x D 400 mm
- 3 drawers: H 65 x W 310 x D 400 mm
- 1 drawer: H 300 x W 310 x D 400 mm
- Heavy-duty construction: 850 kg static load.
- Drawer loading capacity: 40 kg

POLAR®
ROLLER CABINETS, ASSORTMENTS AND STORAGE

MINI

POLAR® MINI trolley is our small and compact trolley, but with same technical features as the standard trolleys. It has been designed to fit underneath our workbench, taking up a minimum of floor space.



TROLLEY DIMENSIONS

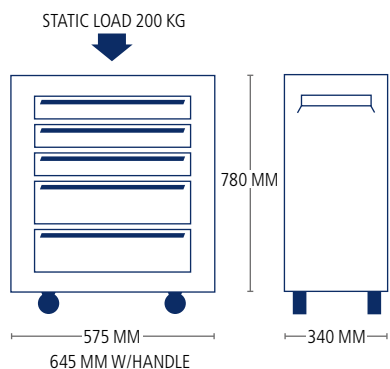

DRAWER DIMENSIONS

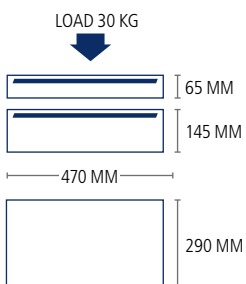

MINI TOOLSETS

66 tools - page 46

MINI ACCESSORIES

Page 40-41

MINI SPAREPARTS

Page 42-43



1000 5D MINI CABINET (EMPTY)

ITEM NO. 10003005

 35 KG

 5704196 016863

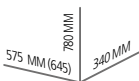

- Empty trolley with 5 drawers.
- 3 drawers: H 65 x W 470 x D 290 mm.
- 2 drawers: H 145 x W 470 x D 290 mm
- Construction: 200 kg static load.
- Drawer loading capacity: 30 kg



The MINI roller cabinet can be stored under the workbench.

POLAR® ROLLER CABINETS, ASSORTMENTS AND STORAGE

TOOL BOXES

1020 TOOL TROLLEY - LIGHT

ITEM NO. 10200001

5704196 030302 HxWxD 360 x 440 x 200 mm 5 KG 1

- Tool trolley with telescopic handle.
- Polypropylen case made with injection molding technique.
- Modern design, with compact dimensions, high capacity and lightweight.
- The aluminum profile grants further strength.

GENERAL FEATURES:

Chromed handle
Central lock with key
2 side closing
Document area
Capacity: 10 liter



1025 TOOL TROLLEY - EXTREME

ITEM NO. 10250001

5704196 030319 HxWxD 375 x 475 x 260 mm 6,4 KG 1

- Tool Trolley with telescopic handle and high thickness Polypropylene casing.
- Polypropylen case made with injection molding technique.
- This material makes the case extremely resistant against chemical corrosion, shock, high and low temperature.
- The injection technique ensures constant material thickness, even in the corners.

GENERAL FEATURES:

2 metal locks with keys
3 metal hinges for maximum strength
Can accommodate up to 3 tool pallets
Bottom area with adjustable/removable dividers
Ergonomic handle
Rubber coated grip
Address label
Document area
Capacity: 35 liter



1050 2D TOOL BOX

ITEM NO. 10500002

5704196 016887 HxWxD 240 x 495 x 225 mm 7,7 KG 1

- 2 drawers mounted on ball bearing slides.
- All drawers are supplied with oil-proof rubber mats.
- Centralized locking. Handles on both sides.
- Drawer loading capacity: 15 kg
- Upper compartment: H 55 x W 440 x D 210 mm
- 2 drawers: H 75 x W 465 x D 195 mm
- Surface: Black and grey powder coating.
- Material: 1,2 mm sheet steel casing.

! Also available with tool set S4 - see page 23.





1005 3D DRAWER CHEST

ITEM NO. 10050003

5704196 016870 HxWxD 340 x 690 x 460 mm 28 KG 1



- 3 drawers mounted on ball bearing slides.
- Front handles with auto-lock system.
- All drawers are supplied with oil-proof rubber mats.
- Centralized locking. Handles on both sides.
- Possible to combine with roller cabinets EASY and X-LARGE.
- Drawer loading capacity: 30 kg. 3 drawers: H 65 x W 580 x D 375 mm
- Surface: Black and grey powder coating.
- Material: 1,2 mm sheet steel casing.

1050 3D TOOL BOX

ITEM NO. 10500003

5704196 027647 HxWxD 300 x 520 x 225 mm 11,3 KG 1



- 3 drawers mounted on ball bearing slides.
- All drawers are with oil-proof rubber mats.
- Centralized locking. Handle on lid. Drawer loading capacity: 15 kg.
- Upper compartment: H 55 x W 505 x D 240 mm.
- 3 drawers: H 50 x W 445 x D 215 mm.
- Surface: Black and grey powder coating.
- Material: 1,2 mm sheet steel casing.

! Also available with tool set S10 - see page 24.

1005 4D DRAWER CHEST

ITEM NO. 10050004

5704196 015675 HxWxD 490 x 660 x 405 mm 33 KG 1



- 4 drawers mounted on ball bearing slides.
- Front handles with auto-lock system. Supplied with tool tray.
- All drawers are supplied with oil-proof rubber mats.
- Centralized locking. Handles on both sides.
- Possible to combine with roller cabinets EASY and X-LARGE.
- Drawer loading capacity: 30 kg
- Upper compartment: H 70 x W 650 x D 390 mm
- 4 drawers: H 75 x W 580 x D 375 mm
- 1 tray: H 43 x W 440 x D 180 mm
- Surface: Black and grey powder coating.
- Material: 1,2 mm sheet steel casing.

1055 5T CANTILEVER TOOL BOX

5704196 024950 HxWxD 250 x 515 x 250 mm 5,4 KG 1



- Long cantilever tool box with five compartments.
- Preset for padlock.
- Inside dimensions: Lower compartment 465 x 120 x 215 mm
4 x compartments 465 x 100 x 55 mm

! Also available with tool set S9 - see page 25.



1005 4DXL DRAWER CHEST

ITEM NO. 10051004

5704196 028590

HxWxD 452 x 865 x 500 mm

44,5 KG

1

- Possible to combine with X-LARGE roller cabinet.
- 4 drawers mounted on ball bearing slides.
- Front handles with auto-lock system.
- All drawers are with oil-proof rubber mats.
- Centralized locking. Handles on both sides.
- Drawer loading capacity: 40 kg.





SIDECABINETS

SUITABLE FOR

EASY - page 28
X-LARGE - page 30
CARGO - page 32

1010 A SIDECABINET WITH 2 SHELVES

ITEM NO. 10100001

5704196 013534 HxWxD 860 x 380 x 460 mm 20 KG 1

- Possible to combine with roller cabinets EASY, X-LARGE and CARGO.
- Shelf loading capacity: 30 kg
- 2 shelves: W 350 x D 420 mm
- Surface: Black and grey powder coating.
- Material: 1,2 mm sheet steel casing.



1010 C SIDECABINET WITH PANEL

ITEM NO. 10100003

5704196 013558 HxWxD 860 x 310 x 460 mm 28 KG 1

- Possible to combine with roller cabinets EASY, X-LARGE and CARGO.
- 1 panel with 30 hooks: H 630 x W 415 mm
- 1 upper compartment: H 65 x W 190 x D 410 mm
- Surface: Black and grey powder coating.
- Material: 1,2 mm sheet steel casing.



1010 B SIDECABINET WITH DRAWERS

ITEM NO. 10100002

5704196 013541 HxWxD 860 x 380 x 460 mm 41 KG 1

- 7 drawers mounted on ball bearing slides.
- All drawers are supplied with oil-proof rubber mats.
- Centralized locking.
- Possible to combine with roller cabinets EASY, X-LARGE and CARGO.
- Drawer loading capacity: 40 kg
- 5 drawers: H 70 x W 265 x D 400 mm
- 2 drawers: H 150 x W 265 x D 400 mm
- Surface: Black and grey powder coating.
- Material: 1,2 mm sheet steel casing.



1090 EASY ROLLER CABINET WITH TWO CABINETS AND TOP CHEST (EMPTY)

ITEM NO. 10900004

1380 MM
1485 MM
460 MM
158 KG
5704196 015606



- Supplied with sidecabinets models 1010 A and B (page 39) and tool chest model 1005 4D (page 36).

POLAR® ROLLER CABINETS, ASSORTMENTS AND STORAGE

ACCESSORIES

1011 A HOLDER FOR SPRAYCANS

ITEM NO. 10110001

5704196 013565 HxWxD 90 x 90 x 430 mm 1,25 KG 1



- Possible to mount on roller cabinets EASY, X-LARGE and CARGO.
- Surface: Black and grey powder coating.
- Material: 1,2 mm sheet steel casing.

1011 C PAPER HOLDER

ITEM NO. 10110003

5704196 013589 HxWxD 100 x 375 x 220 mm 1,25 KG 1



- Possible to mount on roller cabinets EASY, X-LARGE and CARGO.
- Paperroll: Max. width 365 mm, max. Ø 380 mm
- Surface: Black and grey powder coating.
- Material: 2 mm sheet steel casing.

1011 B SIDETABLE

ITEM NO. 10110002

5704196 013572 HxWxD 178 x 405 x 434 mm 4 KG 1



- Possible to mount on roller cabinets EASY, X-LARGE and CARGO.
- Workarea: 434 x 405 mm
- Surface: Black powder coating.
- Material: 1,2 mm sheet steel casing.

1011 D WASTEBASKET

ITEM NO. 10110004

5704196 016511 HxWxD 450 x 365 x 260 mm 1,4 KG 1



- 25-liter plastic bin (including bracket).
- Can be used together with roller cabinets MINI, EASY, X-LARGE and CARGO.



POLAR® ROLLER CABINETS, ASSORTMENTS AND STORAGE

1011 FB EXTERNAL DIVIDERS

▪ To be placed in the front and back of the drawer.



ITEM NO.	5704196+	USABLE FOR TROLLEYS	L MM	H MM	KG	
10110100	016757	EASY	578	50	0,264	1
10110120	016771	X-LARGE	752	50	0,343	1

1011 SQ HORIZONTAL DIVIDERS



ITEM NO.	5704196+	TYPE	L MM	H MM	KG	
10110140	016825	0	80	50	0,048	1
10110141	016818	1	117	50	0,071	1
10110142	016801	2	155	50	0,098	1
10110143	016795	3	193	50	0,119	1

1011 ST VERTICAL DIVIDERS

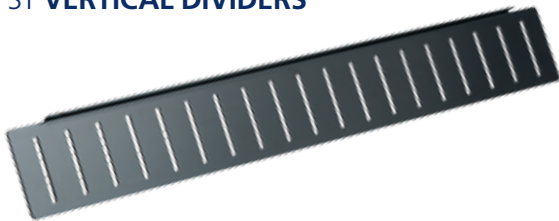

ITEM NO.	5704196+	USABLE FOR TROLLEYS	L MM	H MM	KG	
10110105	016764	EASY	372	50	0,232	1
10110125	016788	X-LARGE	434	50	0,273	1

1011 S/17 SET OF 17 DIVIDERS

ITEM NO. 10110150

5704196 016856

1,3 KG

1



▪ The set contains 6 dividers type 0 - 4 dividers type 1 - 4 dividers type 2 and 3 dividers type 3.

1011 S/6 SET OF DIVIDERS

▪ Set with two external dividers and four vertical dividers.

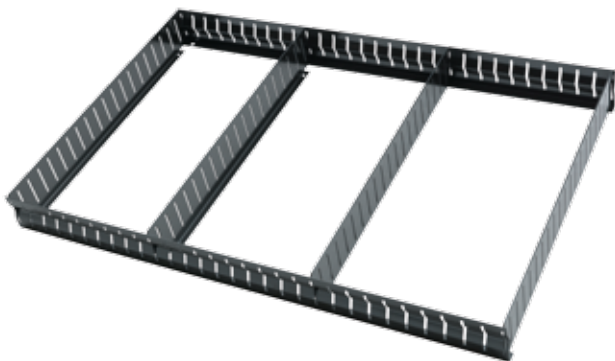

ITEM NO.	5704196+	USABLE FOR TROLLEYS	KG	
10110110	016832	EASY	1,4	1
10110130	016849	X-LARGE	1,8	1



POLAR® ROLLER CABINETS, ASSORTMENTS AND STORAGE

SPAREPARTS

LOCK WITH 2 KEYS FOR ROLLER CABINETS

▪ For all POLAR® STORAGE products.



ITEM NO.	5704196+	G	
P1000000000	016528	67	1

MASTER KEY

▪ For all POLAR® STORAGE products.



ITEM NO.	5704196+	G	
P1000000001	027135	6	1

KEY FOR ROLLER CABINET

▪ For all POLAR® STORAGE products.
▪ On purchase - enlight existing key number.



ITEM NO.	5704196+	G	
P1000000002	027159	6	1

TOPPLATE

▪ For EASY, X-LARGE and CARGO.



ITEM NO.	5704196+	TYPE	HxWxD MM	G	
P1000000005	027104	EASY	13 x 675 x 450	5500	1
P1000100005	027111	X-LARGE	13 x 855 x 490	7750	1
P1000200005	027128	CARGO	13 x 1055 x 470	9400	1

WHEEL WITH BRAKE

▪ Wheel for EASY and X-LARGE with brake.



ITEM NO.	5704196+	WHEEL Ø	G	
P1000000008	027142	120 mm	1579	1

WHEEL

▪ Wheel for EASY and X-LARGE.



ITEM NO.	5704196+	WHEEL Ø	G	
P1000000009	027166	120 mm	1129	1

SET WITH 4 WHEELS

▪ Set with 4 wheels for EASY and X-LARGE - 2 with brakes.



ITEM NO.	5704196+	WHEEL Ø	G	
P1000000031	030449	120 mm	6400	1

POLAR® ROLLER CABINETS, ASSORTMENTS AND STORAGE

MATS FOR ROLLER CABINETS

■ For EASY and X-LARGE.



ITEM NO.	5704196+	TYPE	QTY. PCS.	G	
P1000000010	027173	EASY	7	196	1
P1000100010	027180	X-LARGE	7	250	1
P1000100011	027197	X-LARGE	8	350	1

DRAWER - CARGO



ITEM NO.	5704196+	HxWxD	G	
P1000200020	019444	120 x 935 x 400 mm	7350	1
P1000200021	019437	75 x 570 x 400 mm	3932	1
P1000200022	019420	154 x 570 x 400 mm	5500	1
P1000200023	019413	75 x 310 x 400 mm	2516	1
P1000200024	019406	312 x 310 x 400 mm	5600	1

DRAWER - EASY



ITEM NO.	5704196+	HxWxD	G	
P1000000020	019499	75 x 580 x 375 mm	3333	1
P1000000021	019482	154 x 580 x 375 mm	4276	1
P1000000022	019475	312 x 580 x 375 mm	6600	1

DRAWER - MINI



ITEM NO.	5704196+	HxWxD	G	
P1000300020	019390	75 x 480 x 295 mm	1994	1
P1000300021	019383	154 x 480 x 295 mm	2706	1

DRAWER - X-LARGE



ITEM NO.	5704196+	HxWxD	G	
P1000100020	019468	70 x 750 x 435 mm	5250	1
P1000100021	019451	154 x 750 x 435 mm	6850	1

HANDLE - DRAWER CHESTS

■ For model 1005.



ITEM NO.	5704196+	G	
P1005000401	027203	223	1

POLAR®
ROLLER CABINETS, ASSORTMENTS AND STORAGE

TOOL ASSORTMENTS

POLAR® Modular tool tray system ensures your tools to be in the right place. The POLAR® inlays are made of durable material and protected by a plastic tray, in order to withstand intense use. All tools are carefully arranged and always securely held in the same place.

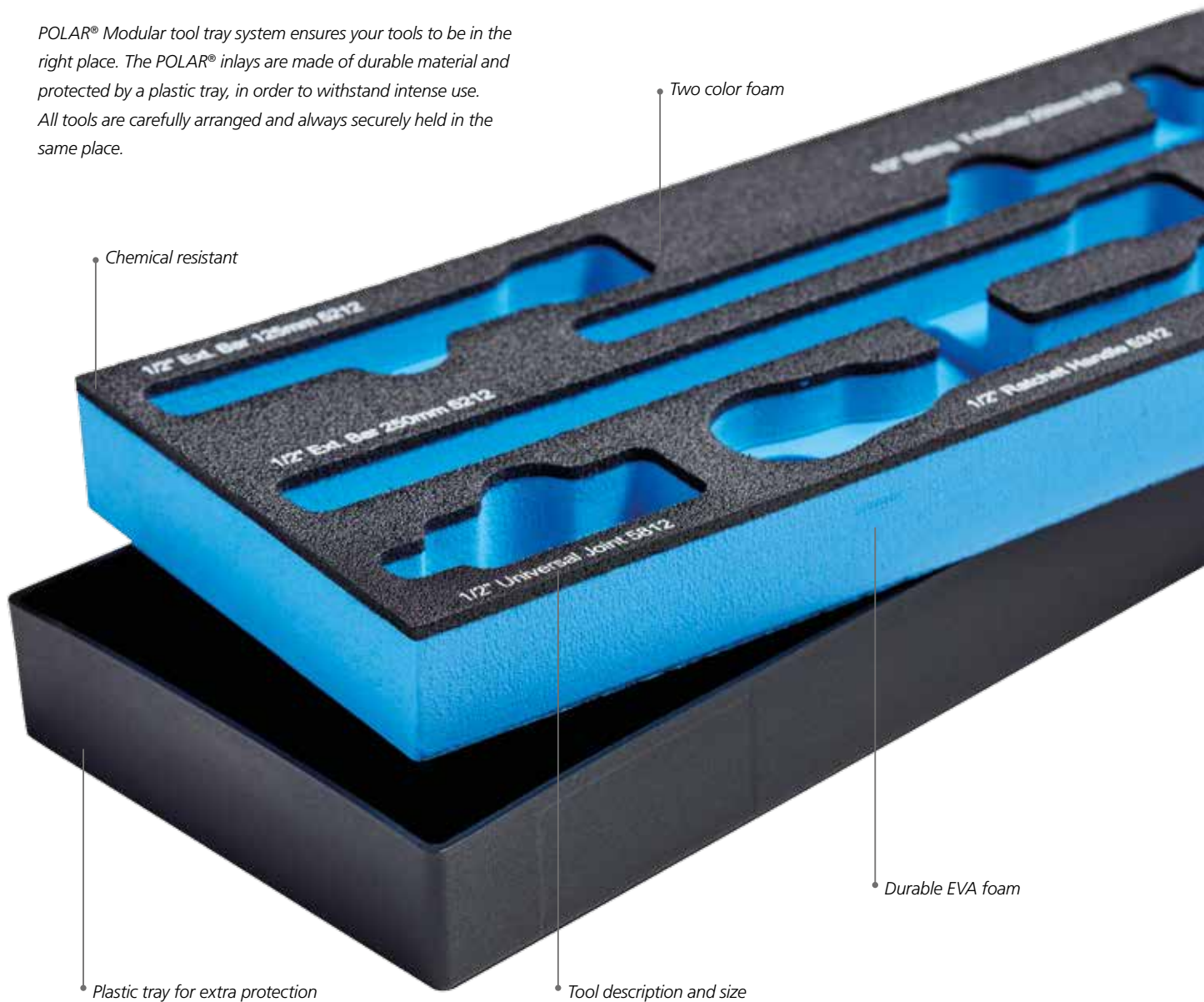

POLAR® ROLLER CABINETS, ASSORTMENTS AND STORAGE



MODULAR TOOL TRAY SYSTEM

The POLAR® Modular tool tray system consists of two different sizes. The 'Triple' type takes up the same space as three 'Single' type trays, as shown in below drawing, giving multiple combinations for our range of trolleys and tool chests.

TOOL ASSORTMENTS

From page 60 to 76.



SINGLE TRAY
370 X 140 MM

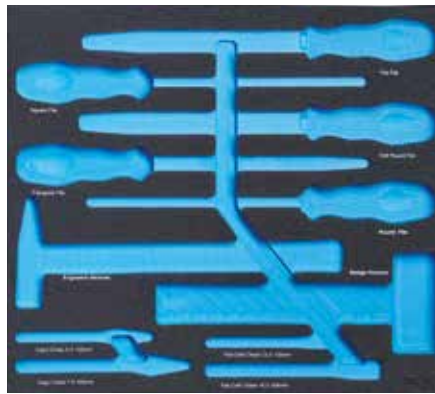

TRIPLE TRAY
370 X 415 MM

EXAMPLES

TOOL TRAYS IN EASY DRAWERS AND DRAWER CHESTS (3D + 4D)

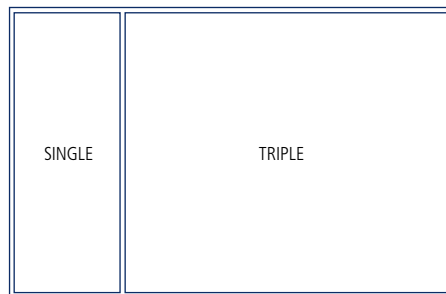
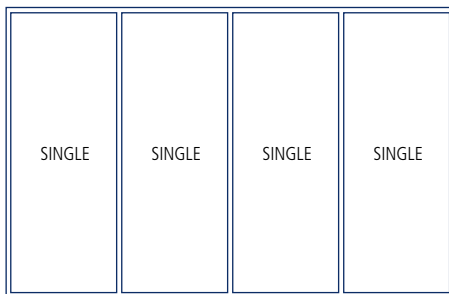

TOOL TRAYS IN X-LARGE DRAWERS

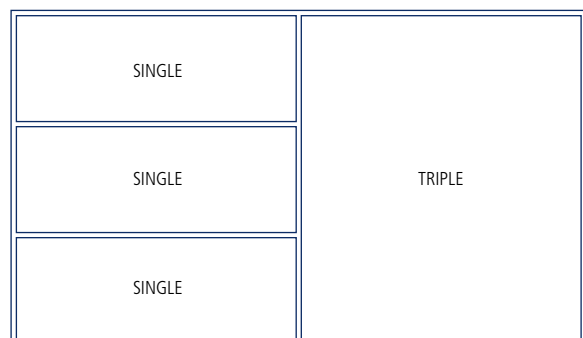
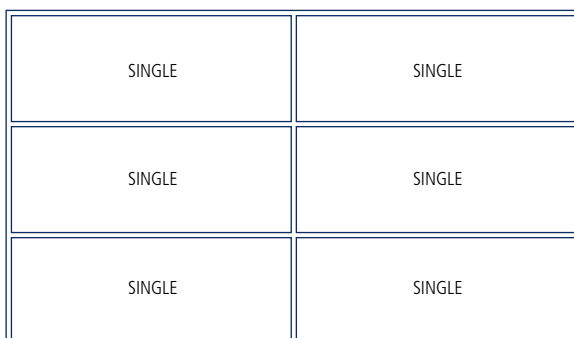

POLAR® ROLLER CABINETS, ASSORTMENTS AND STORAGE

ROLLER CABINETS WITH TOOL ASSORTMENTS

1092 J5M ROLLER CABINET WITH TOOL ASSORTMENT

ITEM NO. 10920066

- MINI roller cabinet with tool set type 1875 S4.
- Worktop in hard PVC material.
- 5 drawers mounted on ball bearing slides.
- Centralized locking.
- 66 tools.

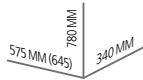

45 KG

5704196018546

**5
DRAWERS**

**66
TOOLS**



CONTENT S4 - 66 TOOLS:



QTY.	DESCRIPTION	SIZE
18	6-point sockets	5012 1/2" 10-11-12-13-14-15-16-17-18-19-20-21-22-23-24-27-30-32mm
1	Ratchet, 60 teeth	5312 1/2" E
2	Extensions	5212 1/2" EX 125 - 250 mm
1	Sliding T-handle	5412 1/2" TH
1	Universal joint	5812 1/2" U
4	Screwdrivers for slotted head screws	4000 3 x 75 - 4 x 100 - 5,5 x 125 - 6,5 x 150 mm
3	Screwdrivers for Phillips®screws	4010 PH 1 - PH 2 - PH 3
14	Combination wrenches	2000 8 - 9 - 10 - 11 - 12 - 13 - 14 - 15 - 16 - 17 - 18 - 19 - 21 - 22 mm
1	Combination plier	3001 180 mm
1	Diagonal cutter	3002 160 mm
1	Half-round long nose plier	3005 160 mm

QTY.	DESCRIPTION	SIZE
1	Waterpump plier	3020 250 mm
1	Locking plier	3202 250 mm
1	Electricians scissor	3500 140 mm
9	Long metric hexagon keys	4105 BP 1.5 - 2 - 2.5 - 3 - 4 - 5 - 6 - 8 - 10 mm
1	Mechanics hammer	8030 300 g
1	Taper punch	8205 3 x 120 mm
1	Center punch	8210 2 x 120 mm
1	Cape chisel	8215 5 x 130 mm
1	Flat chisel	8220 12 x 130 mm
1	Pin punch	8200 4 x 150 mm
1	Hacksaw	9210 300 mm

POLAR®
ROLLER CABINETS, ASSORTMENTS AND STORAGE



1091 B7E ROLLER CABINET
WITH TOOL ASSORTMENT

ITEM NO. 10910163

- EASY roller cabinet with tool set type 1875 S5.
- 7 drawers.
- 163 tools.

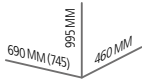

90 KG

5704196 020396

163
TOOLS

7
DRAWERS



55 CONTENT:



- 1800 Combination wrench set 8 - 19 mm
- 1801 Combination wrench set 20 - 24 mm
- 1814 1/4" Socket wrench set 4 - 14 mm
- 1819 1/2" Socket wrench set 10 - 32 mm



- 1827 1/2" Ratchet and accessories
- 1829 B Screwdriver set for slotted head screws
- 1830 C Screwdriver set, PH
- 1831 A Screwdriver set, TX



- 1834 Metric and Torx® hexagon key set
- 1835 Plier set with combination-, cutting- and long nose plier
- 1836 Plier set with waterpump- and locking pliers
- 1845 Measuring and cutting tool set

163
TOOLS

8
DRAWERS



1091 B8E ROLLER CABINET
WITH TOOL ASSORTMENT

ITEM NO. 10918163

- EASY roller cabinet with tool set type 1875 S5.
- 8 drawers.
- 163 tools.

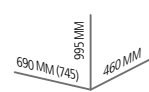

92 KG

5704196 029436

POLAR®
ROLLER CABINETS, ASSORTMENTS AND STORAGE

1091 A7E ROLLER CABINET WITH TOOL ASSORTMENT

ITEM NO. 10910350

- EASY roller cabinet with tool set type 1875 S1.
- 7 drawers.
- 350 tools.

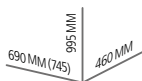

106 KG

5704196 020402



1091 A8E ROLLER CABINET WITH TOOL ASSORTMENT

ITEM NO. 10918350

- EASY roller cabinet with tool set type 1875 S1.
- 8 drawers.
- 350 tools.

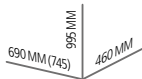

108 KG

5704196 029443



POLAR® ROLLER CABINETS, ASSORTMENTS AND STORAGE

S1 CONTENT: (BOTH A7E AND A8E)



- 1800 Combination wrench set 8 - 19 mm
- 1801 Combination wrench set 20 - 24 mm
- 1807 Reversible ratchet combination wrench set 8 - 19 mm
- 1812 Double swivel end socket wrench set 8 - 19 mm



- 1813 1/4" Socket wrench set 4 - 14 mm
- 1815 1/4" Long sockets and socket drivers
- 1817 3/8" Socket wrench set 6 - 22 mm
- 1819 1/2" Socket wrench set 10 - 32 mm



- 1820 1/2" Long sockets 10 - 24 mm
- 1825 1/2" Long socket drivers for hex head screws 5 - 19 mm
- 1826 1/2" Long socket drivers for Torx® screws T10 - T50
- 1827 1/2" Ratchet and accessories



- 1829 B Screwdriver set for slotted head screws
- 1830 C Screwdriver set, PH
- 1831 A Screwdriver set, TX
- 1834 Metric and Torx® hexagon key set



- 1835 Plier set with combination-, cutting- and long nose pliers
- 1836 Plier set with waterpump- and locking plier
- 1837 Adjustable wrenches 6" - 8" - 10"
- 1843 Bits set



- 1839 Hammers, chisels and files set
- 1845 Measuring and cutting tool set

POLAR® ROLLER CABINETS, ASSORTMENTS AND STORAGE

S2 CONTENT: (BOTH F8E, F10E AND F11E)



- 1800 Combination wrench set 8 - 19 mm
- 1801 Combination wrench set 20 - 24 mm
- 1807 Reversible ratchet combination wrench set 8 - 19 mm
- 1812 Double swivel end socket wrench set 8 - 19 mm



- 1813 1/4" Socket wrench set 4 - 14 mm
- 1815 1/4" Long sockets and socket drivers
- 1817 3/8" Socket wrench set 6 - 22 mm
- 1819 1/2" Socket wrench set 10 - 32 mm



- 1820 1/2" Long sockets 10 - 24 mm
- 1824 1/2" Socket drivers for slot-head, Phillips®, Pozidriv® and hexagonal screws
- 1825 1/2" Long socket drivers for hex head screws 5 - 19 mm
- 1826 1/2" Long socket drivers for Torx® screws T10 - T50



- 1827 1/2" Ratchet and accessories
- 1829 Screwdriver set
- 1830 Screwdriver set for Phillips® and Pozidriv® screws
- 1831 Screwdriver set, TX



- 1834 Metric and Torx® hexagon key set
- 1835 Plier set with combination-, cutting- and long nose pliers
- 1836 Plier set with waterpump- and locking pliers
- 1837 Adjustable wrenches 6" - 8" - 10"



- 1839 Hammers, chisels and files set
- 1841 Plier set for circlips 19 - 60 mm



- 1842 1/2" Impact socket set
- 1840 Impact tool set
- 1843 Bits set
- 1844 Measuring and cutting tool set



- 1845 Measuring and cutting tool set
- 1847 Impact driver bit set
- 1848 Screwdriver set, hex
- 1849 Screwdriver set

1091 F10E ROLLER CABINET WITH TOOL ASSORTMENT

ITEM NO. 10910425

- EASY roller cabinet and top drawer chest with tool set type 1875 S2.
- 10 drawers.
- 425 tools.

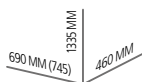

145 KG

5704196 020372

425 TOOLS

10 DRAWERS



1091 F8E ROLLER CABINET WITH TOOL ASSORTMENT

ITEM NO. 10918425

- EASY roller cabinet with tool set type 1875 S2.
- 8 drawers.
- 425 tools.

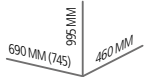

119 KG

5704196 029450



425 TOOLS

8 DRAWERS

1091 F11E ROLLER CABINET WITH TOOL ASSORTMENT

ITEM NO. 10928425

- EASY roller cabinet and top drawer chest with tool set type 1875 S2.
- 11 drawers. 425 tools.

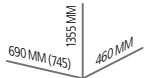

147 KG

5704196 029467



425 TOOLS

11 DRAWERS



POLAR®
ROLLER CABINETS, ASSORTMENTS AND STORAGE

1091 A7XL ROLLER CABINET WITH TOOL ASSORTMENT

ITEM NO. 10911350

- X-LARGE roller cabinet with tool set type 1875 S1.
- 7 drawers.
- 350 tools.

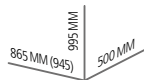

128 KG

5704196 021799

350 TOOLS

7 DRAWERS



1091 A8XL ROLLER CABINET WITH TOOL ASSORTMENT

ITEM NO. 10912350

- X-LARGE roller cabinet with tool set type 1875 S1.
- 8 drawers.
- 350 tools.

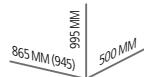

128,5 KG

5704196 021805

350 TOOLS

8 DRAWERS



POLAR® ROLLER CABINETS, ASSORTMENTS AND STORAGE

S1 CONTENT: (BOTH A7XL AND A8XL)



1800 Combination wrench set 8 - 19 mm
1801 Combination wrench set 20 - 24 mm
1807 Reversible ratchet combination wrench set 8 - 19 mm

1812 Double swivel end socket wrench set 8 - 19 mm
1813 1/4" Socket wrench set 4 - 14 mm
1815 1/4" Long sockets and socket drivers



1817 3/8" Socket wrench set 6 - 22 mm
1819 1/2" Socket wrench set 10 - 32 mm
1820 1/2" Long sockets 10 - 24 mm

1825 1/2" Long socket drivers for hex head screws 5 - 19 mm
1826 1/2" Long socket drivers for Torx® screws T10 - T50
1827 1/2" Ratchet and accessories



1829 B Screwdriver set for slotted head screws
1830 C Screwdriver set, PH
1831 A Screwdriver set, TX

1834 Metric and Torx® hexagon key set
1835 Plier set with combination-, cutting- and long nose pliers
1836 Plier set with waterpump- and locking plier



1837 Adjustable wrenches 6" - 8" - 10"
1843 Bits set
1845 Measuring and cutting tools set

1839 Hammers, chisels and files set







1091 H8XL ROLLER CABINET WITH TOOL ASSORTMENT

ITEM NO. 10911447

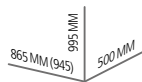
- X-LARGE roller cabinet with tool set type 1875 S7.
- 8 drawers.
- 447 tools.



 138 KG

 5704196 020389

POLAR® ROLLER CABINETS, ASSORTMENTS AND STORAGE

57 CONTENT:



- 1800 Combination wrench set 8 - 19 mm
- 1801 Combination wrench set 20 - 24 mm
- 1805 A Metric double open end wrench set 6 - 23 mm
- 1805 B Metric double open end wrench set 24-32 mm
- 1807 Reversible ratchet combination wrench set 8 - 19 mm
- 1812 Double swivel end socket wrench set 8 - 19 mm



- 1813 1/4" Socket wrench set 4 - 14 mm
- 1815 1/4" Long sockets and socket drivers
- 1817 3/8" Socket wrench set 6 - 22 mm
- 1819 1/2" Socket wrench set 10 - 32 mm
- 1820 1/2" Long sockets 10 - 24 mm
- 1824 1/2" Socket drivers for slot-head, Phillips®, Pozidriv® and hexagonal screws



- 1825 1/2" Long socket drivers for hex head screws 5 - 19 mm
- 1826 1/2" Long socket drivers for Torx® screws T10 - T50
- 1827 1/2" Ratchet and accessories
- 1829 B Screwdriver set for slotted head screws
- 1830 C Screwdriver set, PH
- 1830 B Screwdriver set, PZ



- 1831 A Screwdriver set, TX
- 1834 Metric and Torx® hexagon key set
- 1835 Plier set with combination-, cutting- and long nose pliers
- 1836 Plier set with waterpump- and locking pliers
- 1837 Adjustable wrenches 6" - 8" - 10"
- 1841 Plier set for circlips 19 - 60 mm



- 1842 1/2" Impact socket set
- 1843 Bits set
- 1844 Measuring and cutting tool set
- 1845 Measuring and cutting tool set
- 1848 Screwdriver set, hex
- 1849 Screwdriver set



- 1846 Impact accessories
- 1847 Impact driver bit set
- 1840 Impact tool set
- 1839 Hammers, chisels and files set

POLAR® ROLLER CABINETS, ASSORTMENTS AND STORAGE

1091 C7XL ROLLER CABINET WITH TOOL ASSORTMENT

ITEM NO. 10910470

- X-LARGE roller cabinet with tool set type 1875 S3 (p. 80-81).
- 7 drawers.
- 470 tools.

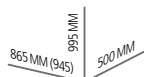

136 KG

5704196 015644



1091 C8XL ROLLER CABINET WITH TOOL ASSORTMENT

ITEM NO. 10911470

- X-LARGE roller cabinet with tool set type 1875 S3 (p. 80-81).
- 8 drawers.
- 470 tools.

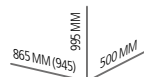

137 KG

5704196 015774



S3 CONTENT: (FOR SPECIFIC CONTENT SEE PAGE 80-81)



Screwdriver set (Item no. 1875-0470-1)



Pliers, circlips pliers and cutting tools (Item no. 1875-0470-5)

POLAR® ROLLER CABINETS, ASSORTMENTS AND STORAGE

S3 CONTENT: (FOR SPECIFIC CONTENT SEE PAGE 80-81)



1/2" Socket wrench set
1/2" Torque wrench
(Item no. 1875-0470-3)



Combination and double swivel end socket wrenches
Reversible gear combination wrenches
(Item no. 1875-0470-8)



1/4" - 3/8" - 1/2" Metric sockets, socket drivers and accessories
1/4" - 3/8" Torque wrenches
(Item no. 1875-0470-2)



Bits, hammers and impact tools (Item no. 1875-0470-7)



Impact driver, adjustable wrenches, hexagonal keys, files and measuring tools (Item no. 1875-0470-6)

POLAR® ROLLER CABINETS, ASSORTMENTS AND STORAGE

1091 D7XL ROLLER CABINET WITH TOOL ASSORTMENT

ITEM NO. 10910473

- X-LARGE roller cabinet with tool set type 1875 S6 (p. 84-85).
- 7 drawers.
- 473 tools.

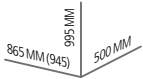

137 KG

5704196018676



473 TOOLS

7 DRAWERS

1091 D8XL ROLLER CABINET WITH TOOL ASSORTMENT

ITEM NO. 10911473

- X-LARGE roller cabinet with tool set type 1875 S6 (p. 84-85).
- 8 drawers.
- 473 tools.

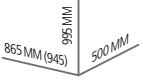

138 KG

5704196 018669



473 TOOLS

8 DRAWERS

S6 CONTENT: (FOR SPECIFIC CONTENT SEE PAGE 84-85)



Screwdriver set (Item no. 1875-0470-1)



Pliers, circlips pliers and cutting tools (Item no. 1875-0470-5)

POLAR® ROLLER CABINETS, ASSORTMENTS AND STORAGE

56 CONTENT: (FOR SPECIFIC CONTENT SEE PAGE 84-85)



1/2" Socket wrench set
1/2" Torque wrench
(Item no. 1875-0470-3)

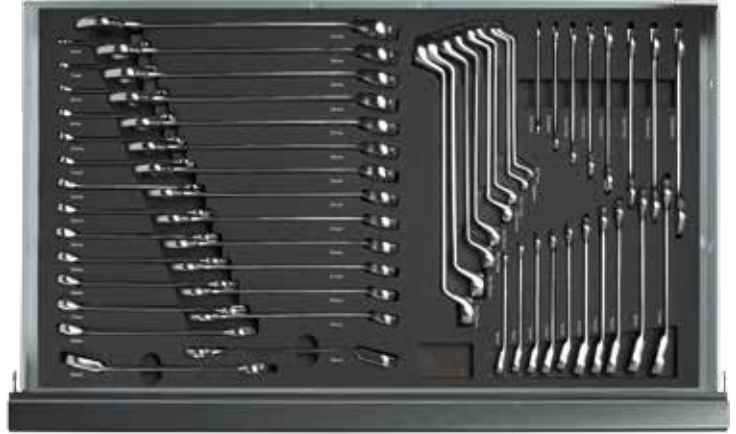

Combination wrenches, double end ring wrenches and double open end wrenches
Reversible gear combination wrenches
(Item no. 1875-0470-4)



1/4" - 3/8" - 1/2" Metric sockets, socket drivers and accessories
1/4" - 3/8" Torque wrenches
(Item no. 1875-0470-2)



Bits, hammers and impact tools (Item no. 1875-0470-7)



Impact driver, adjustable wrenches, hexagonal keys, files and measuring tools (Item no. 1875-0470-6)

POLAR® ROLLER CABINETS, ASSORTMENTS AND STORAGE

TOOL ASSORTMENTS

1800 METRIC COMBINATION WRENCH SET

ITEM NO. 18000012
 5704196 014135 WxDxH 370 x 140 x 40 1,2 KG 1

Set with combination wrenches from 8 to 19 mm supplied in plastbox with re-inforced EVA foam. 12 tools.



12 TOOLS

CONTENT:

QTY.	DESCRIPTION	SIZE
12	Combination wrenches	2000 8 - 9 - 10 - 11 - 12 - 13 - 14 - 15 - 16 - 17 - 18 - 19 mm

1800 EMPTY PLASTBOX WITH EVA FOAM

5704196 014340 WxDxH 370 x 140 x 40 0,3 KG

1801 METRIC COMBINATION WRENCH SET

ITEM NO. 18010005
 5704196 014142 WxDxH 370 x 140 x 40 1,3 KG 1

Set with combination wrenches from 20 to 24 mm supplied in plastbox with re-inforced EVA foam. 5 tools.



5 TOOLS

CONTENT:

QTY.	DESCRIPTION	SIZE
5	Combination wrenches	2000 20 - 21 - 22 - 23 - 24 mm

1801 EMPTY PLASTBOX WITH EVA FOAM

5704196 014333 WxDxH 370 x 140 x 40 0,3 KG

1802 METRIC COMBINATION WRENCH SET

ITEM NO. 18020026
 5704196 014159 WxDxH 415 x 370 x 40 5,9 KG 1

Set with combination wrenches from 6 to 32 mm supplied in plastbox with re-inforced EVA foam. 26 tools.



26 TOOLS

CONTENT:

QTY.	DESCRIPTION	SIZE
26	Combination wrenches	2000 6 - 7 - 8 - 9 - 10 - 11 - 12 - 13 - 14 - 15 - 16 - 17 - 18 - 19 - 20 - 21 - 22 - 23 - 24 - 25 - 26 - 27 - 28 - 29 - 30 - 32 mm

1802 EMPTY PLASTBOX WITH EVA FOAM

5704196 014326 WxDxH 415 x 370 x 40 0,8 KG





1804 INCH COMBINATION WRENCH SET

ITEM NO. 18040016
 5704196 014173 **WxDxH** 415 x 370 x 40 3,9 KG 1

- Set with combination wrenches from 1/4" to 1-1/4" supplied in plastbox with re-inforced EVA foam. 16 tools.



CONTENT:

QTY.	DESCRIPTION	SIZE
16	Combination wrenches	2000 1/4 - 5/16 - 3/8 - 7/16 - 1/2 - 9/16 - 5/8 - 11/16 - 3/4 - 13/16 - 7/8 - 15/16 - 1 - 1-1/16 - 1-1/8 - 1-1/4"

ITEM NO. 18041016 **1804 EMPTY PLASTBOX WITH EVA FOAM**
 5704196 014302 **WxDxH** 370 x 415 x 40 0,8 KG



1805 A METRIC DOUBLE OPEN END WRENCH SET

ITEM NO. 18050009
 5704196 018188 **WxDxH** 370 x 140 x 40 1,2 KG 1

- Set with double open end wrenches from 6 to 23 mm supplied in plastbox with re-inforced EVA foam. 9 tools.



CONTENT:

QTY.	DESCRIPTION	SIZE
9	Double open end wrenches	2010 6x7 - 8x9 - 10x11 - 12x13 - 14x15 - 16x17 - 18x19 - 20x22 - 21x23 mm

ITEM NO. 18051009 **1805 A EMPTY PLASTBOX WITH EVA FOAM**
 5704196 018195 **WxDxH** 370 x 140 x 40 0,3 KG

1805 B METRIC DOUBLE OPEN END WRENCH SET

ITEM NO. 18050003
 5704196 018201 **WxDxH** 370 x 140 x 40 1,35 KG 1

- Set with double open end wrenches from 24 to 32 mm supplied in plastbox with re-inforced EVA foam. 3 tools.



CONTENT:

QTY.	DESCRIPTION	SIZE
3	Double open end wrenches	2010 24x27 - 25x28 - 30x32 mm

ITEM NO. 18051003 **1805 B EMPTY PLASTBOX WITH EVA FOAM**
 5704196 018218 **WxDxH** 370 x 140 x 40 0,3 KG

POLAR® ROLLER CABINETS, ASSORTMENTS AND STORAGE

1807 REVERSIBLE GEAR COMBINATION WRENCH SET

ITEM NO. 18070012
 5704196 014104 **WxDxH** 370 x 140 x 40 **1,7 KG** **1**

Set with reversible gear combination wrenches from 8 to 19 mm supplied in plastbox with re-inforced EVA foam. 12 tools.



CONTENT:

QTY.	DESCRIPTION	SIZE
12	Reversible gear combination wrenches	2005 8 - 9 - 10 - 11 - 12 - 13 - 14 - 15 - 16 - 17 - 18 - 19 mm

1807 EMPTY PLASTBOX WITH EVA FOAM

ITEM NO. 18071012
 5704196 014357 **WxDxH** 370 x 140 x 40 **0,3 KG**

1808 SWIVEL GEAR COMBINATION WRENCH SET

ITEM NO. 18080012
 5704196 014111 **WxDxH** 370 x 140 x 40 **1,9 KG** **1**

Set with swivel gear combination wrenches from 8 to 19 mm supplied in plastbox with re-inforced EVA foam. 12 tools.



CONTENT:

QTY.	DESCRIPTION	SIZE
12	Swivel gear combination wrenches	2405 8 - 9 - 10 - 11 - 12 - 13 - 14 - 15 - 16 - 17 - 18 - 19 mm

1808 EMPTY PLASTBOX WITH EVA FOAM

ITEM NO. 18081012
 5704196 014364 **WxDxH** 370 x 140 x 40 **0,3 KG**

1809 METRIC OFFSET COMBINATION WRENCH SET

ITEM NO. 18090018
 5704196 014203 **WxDxH** 415 x 370 x 40 **4,2 KG** **1**

Set with offset combination wrenches from 8 to 32 mm supplied in plastbox with re-inforced EVA foam. 18 tools.



CONTENT:

QTY.	DESCRIPTION	SIZE
18	Offset combination wrenches	2100 8 - 9 - 10 - 11 - 12 - 13 - 14 - 15 - 16 - 17 - 18 - 19 21 - 22 - 24 - 27 - 30 - 32 mm

1809 EMPTY PLASTBOX WITH EVA FOAM

ITEM NO. 18091018
 5704196 014272 **WxDxH** 415 x 370 x 40 **0,8 KG**





1810 A METRIC DOUBLE END OFFSET RING WRENCH SET

ITEM NO. 18100005

5704196 018430 **WxDxH** 370 x 140 x 40 0,7 KG 1

- Set with double end offset ring wrenches from 6 to 15 mm supplied in plastbox with re-inforced EVA foam. 5 tools.

5 TOOLS



CONTENT:

QTY.	DESCRIPTION	SIZE
5	Double end offset ring wrenches	2110 6x7 - 8x9 - 10x11 - 12x13 - 14x15 mm

1811 METRIC FLARE NUT WRENCH SET

ITEM NO. 18110007

5704196 017228 **WxDxH** 370 x 140 x 40 1,3 KG 1

- Set with flare nut wrenches from 8 to 27 mm supplied in plastbox with re-inforced EVA foam. 7 tools.

7 TOOLS



CONTENT:

QTY.	DESCRIPTION	SIZE
7	Flare nut wrenches	2200 8x10 - 9x11 - 11x13 - 12x14 - 17x19 - 19x22 - 24x27 mm

1810 A EMPTY PLASTBOX WITH EVA FOAM

5704196 018447 **WxDxH** 370 x 140 x 40 0,3 KG

1811 EMPTY PLASTBOX WITH EVA FOAM

5704196 017235 **WxDxH** 370 x 140 x 40 0,3 KG

1810 B METRIC DOUBLE END OFFSET RING WRENCH SET

ITEM NO. 18100003

5704196 018454 **WxDxH** 370 x 140 x 40 1,0 KG 1

- Set with double end offset ring wrenches from 16 to 22 mm supplied in plastbox with re-inforced EVA foam. 3 tools.

3 TOOLS



CONTENT:

QTY.	DESCRIPTION	SIZE
3	Double end offset ring wrenches	2110 16x17 - 18x19 - 20x22 mm

1812 METRIC DOUBLE SWIVEL END SOCKET WRENCH SET

ITEM NO. 18120006

5704196 014234 **WxDxH** 370 x 140 x 40 1,6 KG 1

- Set with double swivel end socket wrenches from 8 to 19 mm supplied in plastbox with re-inforced EVA foam. 6 tools.

6 TOOLS



CONTENT:

QTY.	DESCRIPTION	SIZE
6	Double swivel end socket wrenches	2400 8x9 - 10x11 - 12x13 - 14x15 - 16x17 - 18x19 mm

1810 B EMPTY PLASTBOX WITH EVA FOAM

5704196 018461 **WxDxH** 370 x 140 x 40 0,3 KG

1812 EMPTY PLASTBOX WITH EVA FOAM

5704196 026794 **WxDxH** 370 x 140 x 40 0,3 KG

POLAR® ROLLER CABINETS, ASSORTMENTS AND STORAGE

1813 1/4" METRIC SOCKET WRENCH SET

ITEM NO. 18130017

5704196 014371 **WxDxH** 370 x 140 x 40 **0,8 KG** 1

- Set with 6-point sockets from 4 to 14 mm and accessories supplied in plastbox with re-inforced EVA foam. The set is supplied with a reversible 60 teeth ratchet. 17 tools.



17 TOOLS

CONTENT:

QTY.	DESCRIPTION	SIZE
11	6-point sockets	5014 1/4" 4 - 5 - 6 - 7 - 8 - 9 - 10 - 11 - 12 - 13 - 14 mm
1	Ratchet, 60 teeth	5314 E 1/4"
1	Plastic handle driver	5514 1/4" HD
2	Extensions	5214 1/4" EX 50 - 100 mm
1	Sliding T-handle	5414 1/4" TH
1	Universal joint	5814 1/4" U

ITEM NO. 18131017 1813 EMPTY PLASTBOX WITH EVA FOAM

5704196 014388 **WxDxH** 370 x 140 x 40 **0,3 KG**

1814 1/4" METRIC SOCKET WRENCH SET

ITEM NO. 18140063

5704196 014418 **WxDxH** 370 x 140 x 40 **1,4 KG** 1

- Set with short 6-point sockets from 4 to 14 mm and long 6-point sockets from 4 to 13 mm, bits and accessories, supplied in plastbox with re-inforced EVA foam. The set is supplied with a reversible 60-teeth ratchet. 63 tools.



63 TOOLS

CONTENT:

QTY.	DESCRIPTION	SIZE
11	6-point sockets	5014 1/4" 4 - 5 - 6 - 7 - 8 - 9 - 10 - 11 - 12 - 13 - 14 mm
10	Long 6-point sockets	5014 1/4" L 4 - 5 - 6 - 7 - 8 - 9 - 10 - 11 - 12 - 13 mm
4	Sockets for Torx® screws	5014 1/4" NTX 4 - 5 - 6 - 7
1	Ratchet, 60 teeth	5314 E 1/4"
2	Extensions	5214 1/4" EX 50 - 100 mm
1	Sliding T-handle	5414 1/4" TH
1	Universal joint	5814 1/4" U
1	Plastic handle driver	5514 1/4" HD
1	Screwdriver bit socket	4714 1/4" x 1/4"
1	Bits set, 32 tools	4590 A 1/4"

ITEM NO. 18141063 1814 EMPTY PLASTBOX WITH EVA FOAM

5704196 014425 **WxDxH** 370 x 140 x 40 **0,3 KG**



POLAR® ROLLER CABINETS, ASSORTMENTS AND STORAGE

1815 1/4" SOCKET WRENCH SET

ITEM NO. 18150038

5704196 014395 **WxDxH** 370 x 140 x 40 **0,9 KG** **1**

- Set with long 6-point sockets from 4 to 13 mm, NTX sockets for Torx® screws and socket drivers, supplied in plastbox with re-inforced EVA foam. 38 tools.



38 TOOLS

CONTENT:

QTY.	DESCRIPTION	SIZE
10	Long 6-point sockets	5014 1/4" 4 - 5 - 6 - 7 - 8 - 9 - 10 - 11 - 12 - 13 - 14 mm
6	Sockets for Torx® screws	5014 1/4" NTX E4 - E5 - E6 - E7 - E8 - E10
3	Socket drivers for slotted head screws	5114 1/4" 4 - 5.5 - 7 mm
3	Socket drivers for Phillips® screws	5114 1/4" PH 1 - 2 - 3
3	Socket drivers for Pozidriv® screws	5114 1/4" PZ 1 - 2 - 3
6	Socket drivers for hex head screws	5114 1/4" H 3 - 4 - 5 - 6 - 7 - 8 mm
7	Socket drivers for Tamper Resistant® Torx® screws	5114 1/4" STX T10 - T15 - T20 - T25 - T27 - T30 - T40

ITEM NO. 18151038 1815 EMPTY PLASTBOX WITH EVA FOAM

5704196 014401 **WxDxH** 370 x 140 x 40 **0,3 KG**

1816 1/4" AND 3/8" INCH SOCKET WRENCH SET

ITEM NO. 18160027

5704196 014456 **WxDxH** 370 x 140 x 40 **1,0 KG** **1**

- Set with 6-point sockets from 5/32" to 7/8" and adaptors supplied in plastbox with re-inforced EVA foam. 27 tools.



27 TOOLS

CONTENT:

QTY.	DESCRIPTION	SIZE
11	6-point sockets	5014 1/4" 5/32 - 3/16 - 7/32 - 1/4 - 9/32 - 5/16 - 11/32 - 3/8 - 13/32 - 7/16 - 1/2"
12	6-point sockets	5038 3/8" 1/4 - 5/16 - 3/8 - 7/16 - 1/2 - 9/16 - 19/32 - 5/8 - 11/16 - 3/4 - 13/16 - 7/8"
1	Adaptor	5614 1/4" A
1	Adaptor	5638 3/8" A
1	Adaptor	5738 3/8" A
1	Adaptor	5712 1/2" A

ITEM NO. 18161027 1816 EMPTY PLASTBOX WITH EVA FOAM

5704196 014463 **WxDxH** 370 x 140 x 40 **0,3 KG**

1817 3/8" METRIC SOCKET WRENCH SET

ITEM NO. 18170022

5704196 014432 **WxDxH** 370 x 140 x 40 **1,5 KG** **1**

- Set with 6-point sockets from 6 to 22 mm and accessories supplied in plastbox with re-inforced EVA foam. The set is supplied with a reversible 60 teeth ratchet. 22 tools.



22 TOOLS

CONTENT:

QTY.	DESCRIPTION	SIZE
17	6-point sockets	5038 3/8" 6 - 7 - 8 - 9 - 10 - 11 - 12 - 13 - 14 - 15 - 16 - 17 - 18 - 19 - 20 - 21 - 22 mm
1	Ratchet, 60 teeth	5338 E 3/8"
2	Extensions	5238 3/8" EX 75 - 150 mm
1	Sliding T-handle	5438 3/8" TH
1	Universal joint	5838 3/8" U

ITEM NO. 18171022 1817 EMPTY PLASTBOX WITH EVA FOAM

5704196 014449 **WxDxH** 370 x 140 x 40 **0,3 KG**

1818 3/8" LONG METRIC SOCKET WRENCH SET

ITEM NO. 18180014

5704196 014470 **WxDxH** 370 x 140 x 40 **1,4 KG** **1**

- Set with long 6-point sockets from 8 to 22 mm supplied in plastbox with re-inforced EVA foam. 14 tools.



14 TOOLS

CONTENT:

QTY.	DESCRIPTION	SIZE
14	Long 6-point sockets	5038 3/8" L 8 - 9 - 10 - 11 - 12 - 13 - 14 - 15 - 16 - 17 - 18 - 19 - 21 - 22 mm

ITEM NO. 18181014 1818 EMPTY PLASTBOX WITH EVA FOAM

5704196 014487 **WxDxH** 370 x 140 x 40 **0,3 KG**

POLAR® ROLLER CABINETS, ASSORTMENTS AND STORAGE

1819 1/2" METRIC SOCKET WRENCH SET

ITEM NO. 18190018
 5704196014494 WxDxH 370 x 140 x 40 1,8 KG 1

Set with 6-point sockets from 10 to 32 mm supplied in plastbox with re-inforced EVA foam. 18 tools



CONTENT:

QTY.	DESCRIPTION	SIZE
18	6-point sockets	5012 1/2" 10 - 11 - 12 - 13 - 14 - 15 - 16 - 17 - 18 - 19 - 20 - 21 - 22 - 23 - 24 - 27 - 30 - 32 mm

1821 1/2" METRIC SOCKET WRENCH SET

ITEM NO. 18210018
 5704196014531 WxDxH 370 x 140 x 40 1,8 KG 1

Set with 12-point sockets from 10 to 32 mm supplied in plastbox with re-inforced EVA foam. 18 tools



CONTENT:

QTY.	DESCRIPTION	SIZE
18	12-point sockets	5012 1/2" B 10 - 11 - 12 - 13 - 14 - 15 - 16 - 17 - 18 - 19 - 20 - 21 - 22 - 23 - 24 - 27 - 30 - 32 mm

1819 EMPTY PLASTBOX WITH EVA FOAM

ITEM NO. 18191018
 5704196014500 WxDxH 370 x 140 x 40 0,3 KG

1821 EMPTY PLASTBOX WITH EVA FOAM

ITEM NO. 18211018
 5704196014548 WxDxH 370 x 140 x 40 0,3 KG

1820 1/2" LONG METRIC SOCKET WRENCH SET

ITEM NO. 18200014
 5704196014555 WxDxH 370 x 140 x 40 2,1 KG 1

Set with long 6-point sockets from 10 to 24 mm supplied in plastbox with re-inforced EVA foam. 14 tools



CONTENT:

QTY.	DESCRIPTION	SIZE
14	Long 6-point sockets	5012 1/2" L 10 - 11 - 12 - 13 - 14 - 15 - 16 - 17 - 18 - 19 - 20 - 21 - 22 - 24 mm

1822 1/2" INCH SOCKET WRENCH SET

ITEM NO. 18220017
 5704196014517 WxDxH 370 x 140 x 40 1,8 KG 1

Set with 6-point sockets from 3/8" to 1-1/4" supplied in plastbox with re-inforced EVA foam. 17 tools



CONTENT:

QTY.	DESCRIPTION	SIZE
17	6-point sockets	5012 1/2" 3/8 - 7/16 - 1/2 - 9/16 - 19/32 - 5/8 - 11/16 - 3/4 - 25/32 - 13/16 - 7/8 - 15/16 - 1 - 1-1/16 - 1-1/8 - 1-3/16 - 1-1/4"

1820 EMPTY PLASTBOX WITH EVA FOAM

ITEM NO. 18201014
 5704196014562 WxDxH 370 x 140 x 40 0,3 KG

1822 EMPTY PLASTBOX WITH EVA FOAM

ITEM NO. 18221017
 5704196014524 WxDxH 370 x 140 x 40 0,3 KG

POLAR® ROLLER CABINETS, ASSORTMENTS AND STORAGE

1823 1/2" TORX® SOCKET WRENCH SET

ITEM NO. 18230016

5704196 014579 **WxDxH** 370 x 140 x 40 **1,5 KG** 1

- Set with Torx® socket drivers from T20 to T60 and NTX sockets from E12 to E24 supplied in plastbox with re-inforced EVA foam. 16 tools.



16
TOOLS

CONTENT:

QTY.	DESCRIPTION	SIZE
9	Socket drivers for Torx® screws	5112 1/2" TX T20 - T25 - T27 - T30 - T40 - T45 - T50 - T55 - T60
7	Sockets for Torx® screws	5012 1/2" NTX E12 - E14 - E16 - E18 - E20 - E22 - E24

ITEM NO. 18231016 1823 EMPTY PLASTBOX WITH EVA FOAM

5704196 014586 **WxDxH** 370 x 140 x 40 **0,3 KG**

1824 1/2" SOCKET DRIVER SET

ITEM NO. 18240016

5704196 014593 **WxDxH** 370 x 140 x 40 **1,9 KG** 1

- Set with socket drivers for slotted head, Phillips®, Pozidriv® and hex head screws supplied in plastbox with re-inforced EVA foam. 16 tools.



16
TOOLS

CONTENT:

QTY.	DESCRIPTION	SIZE
3	Socket drivers for slotted head screws	5112 1/2" 8 - 10 - 12 mm
2	Socket drivers for Phillips® screws	5112 1/2" PH 3 - 4
2	Socket drivers for Pozidriv® screws	5112 1/2" PZ 3 - 4
9	Socket drivers for hex head screws	5112 1/2" H 5 - 6 - 7 - 8 - 10 - 12 - 14 - 17 - 19 mm

ITEM NO. 18241016 1824 EMPTY PLASTBOX WITH EVA FOAM

5704196 014609 **WxDxH** 370 x 140 x 40 **0,3 KG**

1825 1/2" SOCKET DRIVER SET

ITEM NO. 18250009

5704196 014616 **WxDxH** 370 x 140 x 40 **1,9 KG** 1

- Set with long socket drivers for hex head screws from 5 to 19 mm supplied in plastbox with re-inforced EVA foam. 9 tools.



9
TOOLS

CONTENT:

QTY.	DESCRIPTION	SIZE
9	Long socket drivers for hex head screws	5112 1/2" HL 5 - 6 - 7 - 8 - 10 - 12 - 14 - 17 - 19 mm

ITEM NO. 18251009 1825 EMPTY PLASTBOX WITH EVA FOAM

5704196 014623 **WxDxH** 370 x 140 x 40 **0,3 KG**

1826 1/2" SOCKET DRIVER SET FOR TORX® SCREWS

ITEM NO. 18260009

5704196 014630 **WxDxH** 370 x 140 x 40 **1,4 KG** 1

- Set with long socket drivers for Torx® screws from T20 to T60 supplied in plastbox with re-inforced EVA foam. 9 tools.



9
TOOLS

CONTENT:

QTY.	DESCRIPTION	SIZE
9	Long socket drivers for Torx® screws	5112 1/2" TXL - T20 - T25 - T27 - T30 - T40 - T45 - T50 - T55 - T60

ITEM NO. 18261009 1826 EMPTY PLASTBOX WITH EVA FOAM

5704196 014647 **WxDxH** 370 x 140 x 40 **0,3 KG**

POLAR® ROLLER CABINETS, ASSORTMENTS AND STORAGE

1827 1/2" RATCHET AND ACCESSORIES

ITEM NO. 18270005

5704196014654 **WxDxH** 370 x 140 x 40 **1,8 KG** **1**

- Set with reversible 60-teeth ratchet and accessories supplied in plastbox with re-inforced EVA foam. 5 tools.



CONTENT:

QTY.	DESCRIPTION	SIZE
1	Ratchet, 60-teeth	5312 E 1/2"
2	Extensions	5212 1/2" EX 125 - 250 mm
1	Sliding T-handle	5412 1/2" TH
1	Universal joint	5812 1/2" U

1829 B SCREWDRIVER SET FOR SLOTTED HEAD SCREWS

ITEM NO. 18290006

5704196019536 **WxDxH** 370 x 140 x 40 **0,7 KG** **1**

- Set with screwdrivers for slotted head screws supplied in plastbox with re-inforced EVA foam. 6 tools.



CONTENT:

QTY.	DESCRIPTION	SIZE
5	Screwdrivers for slotted screws	4000 3x75 - 4x100 - 5.5x125 - 6.5x150 - 8x175 mm
1	Stubby Screwdrivers for slotted screws	4003 5.5x25 mm

1827 EMPTY PLASTBOX WITH EVA FOAM

ITEM NO. 18271005

5704196014661 **WxDxH** 370 x 140 x 40 **0,3 KG**

1828 1/4" - 3/8" - 1/2" RATCHET AND ACCESSORIES

ITEM NO. 18280006

5704196014678 **WxDxH** 370 x 140 x 40 **1,4 KG** **1**

- Set with 3 reversible ratchets and accessories supplied in plastbox with re-inforced EVA foam. 6 tools.



CONTENT:

QTY.	DESCRIPTION	SIZE
1	Ratchet, 60-teeth	5314 E 1/4"
1	Ratchet, 60-teeth	5338 E 3/8"
1	Ratchet, 60-teeth	5312 E 1/2"
1	Extension	5214 1/4" EX 100 mm
1	Wobble extension	5238 3/8" EXW 150 mm
1	Wobble extension	5212 1/2" EXW 150 mm

1828 EMPTY PLASTBOX WITH EVA FOAM

ITEM NO. 18281006

5704196014685 **WxDxH** 370 x 140 x 40 **0,3 KG**

1829 B EMPTY PLASTBOX WITH EVA FOAM

ITEM NO. 18291006

5704196019543 **WxDxH** 370 x 140 x 40 **0,3 KG**





1829 A SCREWDRIVER SET

ITEM NO. 18290012

5704196 013961 WxDxH 415 x 370 x 40 2,2 KG 1

- Set with screwdrivers for slotted head, Torx® and hex head screws supplied in plastbox with re-inforced EVA foam. 12 tools.

12 TOOLS



CONTENT:

QTY.	DESCRIPTION	SIZE
6	Screwdrivers for slotted screws	4000 3x75 - 4x100 - 5.5x125 - 6.5x150 - 8x175 - 10x200 mm
1	Stubby screwdriver for slotted screws	4003 5.5x25 mm
2	Screwdrivers for Torx® screws	4031 TX T30 - T40
2	Flexible hexagonal nut drivers	4042 F 6 - 7 mm
1	Flexible hexagonal nut driver	4042 F 1/4"

ITEM NO. 18291012 1829 EMPTY PLASTBOX WITH EVA FOAM

5704196 014722 WxDxH 415 x 370 x 40 0,8 KG

1830 B SCREWDRIVER SET FOR POZIDRIV® SCREWS

ITEM NO. 18300005

5704196 019550 WxDxH 370 x 140 x 40 0,63 KG 1

- Set with screwdrivers for Pozidriv® screws supplied in plastbox with re-inforced EVA foam. 5 tools.

5 TOOLS



CONTENT:

QTY.	DESCRIPTION	SIZE
3	Screwdrivers for Pozidriv® screws	4020 PZ 1 - 2 - 3
2	Stubby screwdrivers for Pozidriv® screws	4023 PZ 1 - 2

ITEM NO. 18301005 1830 B EMPTY PLASTBOX WITH EVA FOAM

5704196 019567 WxDxH 370 x 140 x 40 0,3 KG

1830 A SCREWDRIVER SET

ITEM NO. 18300006

5704196 013978 WxDxH 370 x 140 x 40 0,7 KG 1

- Set with screwdrivers for Philips® and Pozidriv® screws supplied in plastbox with re-inforced EVA foam. 6 tools.

6 TOOLS

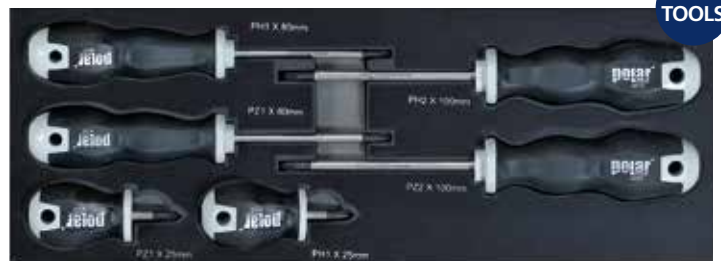

CONTENT:



QTY.	DESCRIPTION	SIZE
2	Screwdrivers for Philips® screws	4010 PH 1 - 2
1	Stubby screwdriver for Philips® screws	4013 PH 1
2	Screwdrivers for Pozidriv® screws	4020 PZ 1 - 2
1	Stubby screwdriver for Pozidriv® screws	4023 PZ 1

ITEM NO. 18301006 1830 EMPTY PLASTBOX WITH EVA FOAM

5704196 014739 WxDxH 370 x 140 x 40 0,3 KG

POLAR® ROLLER CABINETS, ASSORTMENTS AND STORAGE

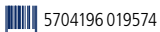
1830 C SCREWDRIVER SET FOR PHILIPS® SCREWS

ITEM NO. 18300106   5704196 019574 **WxDxH** 370 x 140 x 40  0,65 KG  1



- Set with screwdrivers for Philips® screws supplied in plastbox with re-inforced EVA foam. 6 tools.



CONTENT:

QTY.	DESCRIPTION	SIZE
4	Screwdrivers for Phillips® screws	4010 PH 0 - 1 - 2 - 3
2	Stubby screwdrivers for Phillips® screws	4013 PH 1 - 2

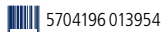
1831 B TORX® SCREWDRIVER SET

ITEM NO. 18310006   5704196 013954 **WxDxH** 370 x 140 x 40  0,7 KG  1

- Set with screwdrivers for Torx® screws supplied in plastbox with re-inforced EVA foam. 6 tools.



CONTENT:

QTY.	DESCRIPTION	SIZE
6	Screwdrivers for Torx® screws	4031 TX T8 - T10 - T15 - T20 - T25 - T27



ITEM NO. 18301106 1830 C EMPTY PLASTBOX WITH EVA FOAM

 5704196 019581 **WxDxH** 370 x 140 x 40  0,3 KG

ITEM NO. 18311006 1831 EMPTY PLASTBOX WITH EVA FOAM

 5704196 014715 **WxDxH** 370 x 140 x 40  0,3 KG

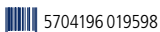
1831 A SCREWDRIVER SET FOR TORX® SCREWS

ITEM NO. 18310005   5704196 019598 **WxDxH** 370 x 140 x 40  0,67 KG  1

- Set with screwdrivers for Torx® screws supplied in plastbox with re-inforced EVA foam. 5 tools.



CONTENT:

QTY.	DESCRIPTION	SIZE
5	Screwdrivers for Torx® screws	4031 TX T20 - T25 - T27 - T30 - T40

ITEM NO. 18311005 1831 A EMPTY PLASTBOX WITH EVA FOAM

 5704196 019604 **WxDxH** 370 x 140 x 40  0,3 KG





1832 3/4" METRIC SOCKET WRENCH SET

ITEM NO. 18320014
 5704196 017143 WxDxH 415 x 370 x 40 10 KG 1

- Set with 6-point sockets from 22 to 50 mm and accessories supplied in plastbox with re-inforced EVA foam. The set is supplied with a reversible 48 teeth ratchet. 14 tools.

14 TOOLS



CONTENT:

QTY.	DESCRIPTION	SIZE
10	6-point sockets	5034 3/4" 22 - 24 - 27 - 30 - 32 - 36 - 38 - 41 - 46 - 50 mm
1	Ratchet, 48 teeth	5334 3/4"
2	Extensions	5234 3/4" EX 100 - 200 mm
1	Sliding T-handle	5434 3/4" TH

ITEM NO. 18321014 1832 EMPTY PLASTBOX WITH EVA FOAM

5704196 017150 WxDxH 415 x 370 x 40 0,8 KG

1833 METRIC AND INCH HEXAGON KEY SET

ITEM NO. 18330038
 5704196 013930 WxDxH 370 x 140 x 40 1,1 KG 1

- Set with long and short hexagon keys with spherical head in plastbox with re-inforced EVA foam. 38 tools

38 TOOLS



CONTENT:

QTY.	DESCRIPTION	SIZE
1	Hexagon key set	4195 FS 8 (1.5 - 2 - 2.5 - 3 - 4 - 5 - 6 - 8 mm)
1	Hexagon key set	4195 FIS 9 (5/64 - 3/32 - 7/64 - 1/8 - 9/64 - 5/32 - 3/16 - 7/32 - 1/4")
1	Long angled hexagon key set	4195 LS 9 (1.5 - 2 - 2.5 - 3 - 4 - 5 - 6 - 8 - 10 mm)
1	Long angled hexagon key set	4195 LIS 12 (1/16 - 5/64 - 3/32 - 7/64 - 1/8 - 9/64 - 5/32 - 3/16 - 7/32 - 1/4 - 5/16 - 3/8")

ITEM NO. 18331038 1833 EMPTY PLASTBOX WITH EVA FOAM

5704196 014692 WxDxH 370 x 140 x 40 0,3 KG

1834 METRIC HEXAGON KEY SET AND TORX® KEY SET

ITEM NO. 18340034
 5704196 013947 WxDxH 370 x 140 x 40 1,1 KG 1

- Set with long and short metric hexagon keys with spherical head and long and short Torx® hexagon keys in plastbox with re-inforced EVA foam. 34 tools.

34 TOOLS



CONTENT:

QTY.	DESCRIPTION	SIZE
1	Hexagon key set	4195 FS 8 (1.5 - 2 - 2.5 - 3 - 4 - 5 - 6 - 8 mm)
1	Torx® key set	4190 FTXS 8 (T9 - T10 - T15 - T20 - T25 - T27 - T30 - T40)
1	Long angled hexagon key set	4195 LS 9 (1.5 - 2 - 2.5 - 3 - 4 - 5 - 6 - 8 - 10 mm)
1	Long angled Torx® key set	4190 LTXS 9 (T8 - T10 - T15 - T20 - T25 - T27 - T30 - T40 - T50)

ITEM NO. 18341034 1834 EMPTY PLASTBOX WITH EVA FOAM

5704196 014708 WxDxH 370 x 140 x 40 0,3 KG

POLAR® ROLLER CABINETS, ASSORTMENTS AND STORAGE

1835 PLIER SET

ITEM NO. 18350004

5704196 013992 **WxDxH** 370 x 140 x 40 **1,3 KG**  1

- Set with 4 pliers supplied in plastbox with re-inforced EVA foam. 4 tools.



4 TOOLS

CONTENT:

QTY.	DESCRIPTION	SIZE
1	Combination plier	3001 180 mm
1	Diagonal cutting plier	3004 180 mm
1	Long nose plier with half-round jaws	3005 200 mm
1	Long nose plier with half-round bent jaws	3006 200 mm

ITEM NO. 18351004 1835 EMPTY PLASTBOX WITH EVA FOAM

5704196 014753 **WxDxH** 370 x 140 x 40 **0,3 KG**

1836 PLIER SET

ITEM NO. 18360002

5704196 014005 **WxDxH** 370 x 140 x 40 **1,2 KG**  1

- Set with 2 pliers supplied in plastbox with re-inforced EVA foam. 2 tools.



2 TOOLS

CONTENT:

QTY.	DESCRIPTION	SIZE
1	Waterpump plier	3020 250 mm
1	Locking plier with curved jaws and cutter	3200 250 mm

ITEM NO. 18361002 1836 EMPTY PLASTBOX WITH EVA FOAM

5704196 014760 **WxDxH** 370 x 140 x 40 **0,3 KG**

1837 ADJUSTABLE WRENCH SET

ITEM NO. 18370003

5704196 014067 **WxDxH** 370 x 140 x 40 **1,2 KG**  1

- Set with 3 adjustable wrenches supplied in plastbox with re-inforced EVA foam. 3 tools.



4 TOOLS

CONTENT:

QTY.	DESCRIPTION	SIZE
3	Adjustable wrenches	2600 150 - 200 - 250 mm / 6" - 8" - 10"

ITEM NO. 18371003 1837 EMPTY PLASTBOX WITH EVA FOAM

5704196 014821 **WxDxH** 370 x 140 x 40 **0,3 KG**

1838 ERGONOMIC ADJUSTABLE WRENCH SET

ITEM NO. 18380003

5704196 014074 **WxDxH** 370 x 140 x 40 **1,1 KG**  1

- Set with 3 adjustable wrenches supplied in plastbox with re-inforced EVA foam. 3 tools.



3 TOOLS

CONTENT:

QTY.	DESCRIPTION	SIZE
3	Adjustable wrenches, Ergo	2605 150 - 200 - 250 mm / 6" - 8" - 10"

ITEM NO. 18381003 1838 EMPTY PLASTBOX WITH EVA FOAM

5704196 014838 **WxDxH** 370 x 140 x 40 **0,3 KG**



1839 HAMMERS, CHISELS AND FILES SET

ITEM NO. 18390011

5704196 014036 **WxDxH** 415 x 370 x 40 **Weight** 3,7 KG **Tools** 1

- Set with mechanics hammer, sledge hammer, chisels and files (second cut) supplied in plastbox with re-inforced EVA foam. 11 tools.



11
TOOLS

CONTENT:

QTY.	DESCRIPTION	SIZE
1	File set (second cut)	3990 S/5 (Flat - Halfround - Square - Round - Triangular)
1	Mechanics hammer	8030 300 g
1	Sledge hammer	8040 1000 g
2	Cape chisels	8215 5 - 7 mm
2	Flat chisels	8220 12 - 18 mm

ITEM NO. 18391011 1839 EMPTY PLASTBOX WITH EVA FOAM

5704196 014791 **WxDxH** 415 x 370 x 40 **Weight** 0,8 KG

1840 IMPACT TOOL SET

ITEM NO. 18400009

5704196 014012 **WxDxH** 370 x 140 x 40 **Weight** 0,9 KG **Tools** 1

- Set with pin punches, taper punches and center punch supplied in plastbox with re-inforced EVA foam. 9 tools.



9
TOOLS

CONTENT:

QTY.	DESCRIPTION	SIZE
6	Pin punches	8200 2 - 3 - 4 - 5 - 6 - 8 mm
2	Taper Punches	8205 3 - 4 mm
1	Center punch	8210 Size 4

ITEM NO. 18401009 1840 EMPTY PLASTBOX WITH EVA FOAM

5704196 014777 **WxDxH** 370 x 140 x 40 **Weight** 0,3 KG

1841 PLIER SET FOR CIRCLIPS

ITEM NO. 18410004

5704196 014128 **WxDxH** 370 x 140 x 40 **Weight** 0,8 KG **Tools** 1

- Set with pliers for internal and external circlips supplied in plastbox with re-inforced EVA foam. 4 tools.



4
TOOLS

CONTENT:

QTY.	DESCRIPTION	SIZE
1	Plier with straight jaws for internal circlips	3100 180 mm - Ø19 - 60 mm
1	Plier with nose bent 90° for internal circlips	3105 180 mm - Ø19 - 60 mm
1	Plier with straight jaws for external circlips	3110 180 mm - Ø19 - 60 mm
1	Plier with nose bent 90° for external circlips	3115 180 mm - Ø19 - 60 mm

ITEM NO. 18411004 1841 EMPTY PLASTBOX WITH EVA FOAM

5704196 014869 **WxDxH** 370 x 140 x 40 **Weight** 0,3 KG

POLAR® ROLLER CABINETS, ASSORTMENTS AND STORAGE

1842 1/2" IMPACT SOCKET SET

ITEM NO. 18420016
 5704196 014098 **WxDxH** 370 x 140 x 40 2,5 KG 1

Set with short and long impact sockets supplied in plastbox with re-inforced EVA foam. 16 tools.



CONTENT:

QTY.	DESCRIPTION	SIZE
12	6-point impact sockets	6012 1/2" 10 - 11 - 12 - 13 - 14 - 15 - 17 - 19 - 21 - 22 - 24 - 27 mm
4	Long 6-point impact sockets	6012 1/2" LT 17 - 19 - 21 - 22 mm

ITEM NO. 18421016 1842 EMPTY PLASTBOX WITH EVA FOAM

5704196 014852 **WxDxH** 370 x 140 x 40 0,3 KG

1843 BITS SET

ITEM NO. 18430109
 5704196 014081 **WxDxH** 370 x 140 x 40 2,5 KG 1

Set with 1/4" bits (103 pcs.), magnetic bit holding screwdriver and accessories supplied in plastbox with re-inforced EVA foam. 109 tools.



CONTENT:

QTY.	DESCRIPTION	SIZE
1	Magnetic bit holding screwdriver	4043 1/4" M
1	Magnetic screwdriver bit socket	4714 1/4" M
1	Screwdriver bit socket	4714 1/4"
1	Flexible extension w/ Quick-Release screwdriver bit socket	4714 1/4" QRF
1	Socket adaptor	4714 1/4" SQ 25 mm
1	Socket adaptor	4714 1/4" SQ 50 mm
6	Bits for slotted head screws	4514 1/4" 3 - 3.5 - 4.5 - 5 - 5.5 - 6.5 mm
5	Bits for Phillips® screws	4514 1/4" PH 0 - 1 - 2 - 3 - 4
3	Bits for Phillips® screws	4514 1/4" ACR PH 1 - 2 - 3
1	Bits for Phillips® drywall screws	4514 1/4" PHR 2
5	Bits for Pozidriv® screws	4514 1/4" PZ 0 - 1 - 2 - 3 - 4
3	Bits for Pozidriv® screws	4514 1/4" ACR PZ 1 - 2 - 3
15	Bits for Torx® screws	4514 1/4" TX 5-6-7-8-9-10-15-20-25-27-30-40-45-50
11	Bits for Tamper Resistant® Torx® head screws	4514 1/4" STX 6-7-8-9-10-15-20-25-27-30-40
10	Bits for hex head screws	4514 1/4" H 1.5 - 2 - 2.5 - 3 - 4 - 5 - 5.5 - 6 - 7 - 8 mm
10	Bits for hex head bore hole screws	4514 1/4" HB 1.5 - 2 - 2.5 - 3 - 4 - 5 - 5.5 - 6 - 7 - 8 mm
6	Bits for hex head bore hole screws	4514 1/4" HB 5/64 - 3/32 - 7/64 - 1/8 - 9/64 - 5/32"
5	Bits for square head screws	4514 1/4" SQ 0 - 1 - 2 - 3 - 4
5	Bits for Spanner screws	4514 1/4" SN 4 - 6 - 8 - 10 - 12
5	Bits for Torq-Set® screws	4514 1/4" TS 4 - 6 - 8 - 10 - 1/4"
4	Bits for XZN screws	4514 1/4" XZN 4 - 5 - 6 - 8
5	Bits for Tri-Wing® screws	4514 1/4" TW 1 - 2 - 3 - 4 - 5
3	Bits for Clutch G screws	4514 1/4" CG 1 - 2 - 3
1	Bits for hooks	4514 1/4" HOOK

ITEM NO. 18431109 1843 EMPTY PLASTBOX WITH EVA FOAM

5704196 014845 **WxDxH** 370 x 140 x 40 0,3 KG





1844 MEASURING AND CUTTING TOOLSET

ITEM NO. 18440005

5704196 014050 **WxDxH** 370 x 140 x 40 **0,9 KG** **1**

- Set with vernier caliper, electrician's scissor, measuring tape and knives supplied in plastbox with re-inforced EVA foam. 5 tools.



5 TOOLS

CONTENT:

QTY.	DESCRIPTION	SIZE
1	Vernier caliper	9200 150 mm
1	Measuring tape	9400 3 mtr
1	Electrician scissor	3500 140 mm
2	Knives	9101 9 mm, 9105 18 mm

ITEM NO. 18441005 1844 EMPTY PLASTBOX WITH EVA FOAM

5704196 014814 **WxDxH** 370 x 140 x 40 **0,3 KG**

1845 MEASURING AND CUTTING TOOLSET

ITEM NO. 18450003

5704196 014029 **WxDxH** 370 x 140 x 40 **0,8 KG** **1**

- Set with junior hacksaw, measuring tape and knife supplied in plastbox with re-inforced EVA foam. 3 tools.



3 TOOLS

CONTENT:

QTY.	DESCRIPTION	SIZE
1	Junior hacksaw	9210 150 mm
1	Knife	9105 18 mm
1	Measuring tape	9400 3 mtr

ITEM NO. 18451003 1845 EMPTY PLASTBOX WITH EVA FOAM

5704196 014784 **WxDxH** 370 x 140 x 40 **0,3 KG**

1846 IMPACT ACCESSORIES

ITEM NO. 18460005

5704196 016030 **WxDxH** 370 x 140 x 40 **1,4 KG** **1**

- Set with extensions, adapters and universal joint supplied in plastbox with re-inforced EVA foam. 5 tools.



5 TOOLS

CONTENT:

QTY.	DESCRIPTION	SIZE
2	Extensions	6212 1/2" EX 75 - 125 mm
2	Adapters	6734 3/4" A - 6638 3/8" A
1	Universal Joint	6812 1/2" U

ITEM NO. 18461005 1846 EMPTY PLASTBOX WITH EVA FOAM

5704196 015378 **WxDxH** 370 x 140 x 40 **0,3 KG**

1847 IMPACT DRIVER BIT SET

ITEM NO. 18470015

5704196 015361 **WxDxH** 370 x 140 x 40 **1,1 KG** **1**

- Set with 1/2" impact driver and 5/16" bits supplied in plastbox with re-inforced EVA foam. 15 tools.



15 TOOLS

CONTENT:

QTY.	DESCRIPTION	SIZE
1	Impact Driver	4712 ID 1/2"
1	Screwdriver bit socket	4712 IB 1/2" x 5/16"
3	Bits for slotted head screws	4516 5/16" 8 - 10 - 12 mm
3	Bits for Phillips® screws	4516 5/16" ACR PH 2 - 3 - 4
4	Bits for Torx® screws	4516 5/16" TX T40 - T45 - T50 - T55
3	Bits for hex head screws	4516 5/16" H 5 - 6 - 8 mm

ITEM NO. 18471015 1847 EMPTY PLASTBOX WITH EVA FOAM

5704196 015378 **WxDxH** 370 x 140 x 40 **0,3 KG**

1848 SCREWDRIVER SET WITH BALL-POINT FOR HEX HEAD SCREWS

ITEM NO. 18480005



5704196 019611 WxDxH 370 x 140 x 40 0,54 KG 1

Set with screwdrivers with ball-point for hex head screws supplied in plastbox with re-inforced EVA foam. 5 tools.

5 TOOLS



CONTENT:

QTY.	DESCRIPTION	SIZE
5	Screwdrivers with ball-point for hex head screws	4035 HBP 2.5 - 3 - 4 - 5 - 6 mm

ITEM NO. 18481005 1848 EMPTY PLASTBOX WITH EVA FOAM

5704196 019628 WxDxH 370 x 140 x 40 0,3 KG

1849 SCREWDRIVER SET FOR TORX® SCREWS, HEXAGONAL NUT DRIVERS AND MAGNETIC BIT HOLDER

ITEM NO. 18490005



5704196 019635 WxDxH 370 x 140 x 40 0,74 KG 1

Set with screwdrivers for Torx® screws, hexagonal nut drivers and magnetic bit holder supplied in plastbox with re-inforced EVA foam. 5 tools.

5 TOOLS



CONTENT:

QTY.	DESCRIPTION	SIZE
2	Screwdrivers for Torx® screws	4031 TX T10 - T15
2	Flexible hexagonal nut drivers	4042 F 1/4" - 7 mm
1	Magnetic bit holding screwdriver	4043 M 1/4"

ITEM NO. 18491005 1849 EMPTY PLASTBOX WITH EVA FOAM

5704196 019642 WxDxH 370 x 140 x 40 0,3 KG



1875 S1 TOOL SET - 350 TOOLS

ITEM NO. 18750350

5704196 020259 44 KG

SUITABLE FOR

EASY - page 48-49
X-LARGE - page 52-53
CARGO - page 32-33

350
TOOLS



CONTENT:

- | | |
|---|--|
| 1800 Combination wrench set 8 - 19 mm | 1827 1/2" Ratchet and accessories |
| 1801 Combination wrench set 20 - 24 mm | 1829 B Screwdriver set for slotted head screws |
| 1807 Reversible ratchet combination wrench set 8 - 19 mm | 1830 C Screwdriver set, PH |
| 1812 Double swivel end socket wrench set 8 - 19 mm | 1831 A Screwdriver set, TX |
| 1813 1/4" Socket wrench set 4 - 14 mm | 1834 Metric and Torx® hexagon key set |
| 1815 1/4" Long sockets and socket drivers | 1835 Plier set with combination-, cutting- and long nose plier |
| 1817 3/8" Socket wrench set 6 - 22 mm | 1836 Plier set with waterpump- and locking plier |
| 1819 1/2" Socket wrench set 10 - 32 mm | 1837 Adjustable wrenches 6" - 8" - 10" |
| 1820 1/2" Long sockets 10 - 24 mm | 1839 Hammers, chisels and files set |
| 1825 1/2" Long socket drivers for hex head screws 5 - 19 mm | 1843 Bits set |
| 1826 1/2" Long socket drivers for Torx® screws T10 - T50 | 1845 Measuring and cutting tool set |

POLAR® ROLLER CABINETS, ASSORTMENTS AND STORAGE

1875 S2 TOOL SET - 425 TOOLS

ITEM NO. 18750425

SUITABLE FOR

EASY - page 50-51

5704196 020365

53 KG

**425
TOOLS**



CONTENT:

- 1800 Combination wrench set 8 - 19 mm
- 1801 Combination wrench set 20 - 24 mm
- 1807 Reversible ratchet combination wrench set 8 - 19 mm
- 1812 Double swivel end socket wrench set 8 - 19 mm
- 1813 1/4" Socket wrench set 4 - 14 mm
- 1815 1/4" Long sockets and socket drivers
- 1817 3/8" Socket wrench set 6 - 22 mm
- 1819 1/2" Socket wrench set 10 - 32 mm
- 1820 1/2" Long sockets 10 - 24 mm
- 1824 1/2" Socket drivers for slot-head, Phillips®, Pozidriv® and hexagonal screws

- 1825 1/2" Long socket drivers for hex head screws 5 - 19 mm
- 1826 1/2" Long socket drivers for Torx® screws T10 - T50
- 1827 1/2" Ratchet and accessories
- 1829 B Screwdriver set for slotted head screws
- 1830 A Screwdriver set for Phillips® and Pozidriv® screws
- 1831 A Screwdriver set, TX
- 1834 Metric and Torx® hexagon key set
- 1835 Plier set with combination-, cutting- and long nose pliers
- 1836 Plier set with waterpump- and locking pliers
- 1837 Adjustable wrenches 6" - 8" - 10"

- 1839 Hammers, chisels and files set
- 1840 Impact tool set
- 1841 Plier set for circlips 19 - 60 mm
- 1842 1/2" Impact socket set
- 1843 Bits set
- 1844 Measuring and cutting tool set
- 1845 Measuring and cutting tool set
- 1847 Impact driver bit set
- 1848 Screwdriver set, hex
- 1849 Screwdriver set



polar
EASY

EASY

POLAR® ROLLER CABINETS, ASSORTMENTS AND STORAGE

1875 S3 TOOL SET - 470 TOOLS

ITEM NO. 18750470

5704196 015385

52 KG

SUITABLE FOR

X-LARGE - page 56-57

**470
TOOLS**

METRIC SOCKETS, SOCKET DRIVERS AND ACCESSORIES, TORQUE WRENCHES



CONTENT: (Item no. 1875-0470-2)

QTY.	DESCRIPTION	SIZE
13	6-point sockets	5014 1/4" 4 - 4.5 - 5 - 5.5 - 6 - 7 - 8 - 9 - 10 - 11 - 12 - 13 - 14 mm
11	Long 6-point sockets	5014 1/4" L 4 - 5 - 5.5 - 6 - 7 - 8 - 9 - 10 - 11 - 12 - 13 - mm
3	Socket drivers for slotted head screws	5114 1/4" 4 - 5.5 - 7 mm
3	Socket drivers for Phillips® screws	5114 1/4" PH 1 - 2 - 3
3	Socket drivers for Pozidriv® screws	5114 1/4" PZ 1 - 2 - 3
6	Socket drivers for hex head screws	5114 1/4" H 3 - 4 - 5 - 6 - 7 - 8 mm
7	Socket drivers for Tamper Resistant® Torx® screws	5114 1/4" STX T10 - T15 - T20 - T25 - T27 - T30 - T40
6	Socket for Torx® screws	5014 1/4" NTX E4 - E5 - E6 - E7 - E8 - E10
1	Screwdriver bit socket	4714 1/4" x 1/4"
3	Extensions	5214 1/4" EX 50 - 100 - 150 mm
1	Flexible extension	5214 1/4" F 150 mm
1	Adaptor	5614 1/4" A
1	Universal joint	5814 1/4" U
1	Sliding T-handle	5414 1/4" TH
1	Spinner handle	5514 1/4" HD
1	Ratchet, 60 teeth	5314 1/4" E
17	6-point sockets	5038 3/8" 6 - 7 - 8 - 9 - 10 - 11 - 12 - 13 - 14 - 15 - 16 - 17 - 18 - 19 - 20 - 21 - 22 mm
14	Long 6-point sockets	5038 3/8" L 8 - 9 - 10 - 11 - 12 - 13 - 14 - 15 - 16 - 17 - 18 - 19 - 21 - 22 mm
3	Extensions	5238 3/8" EX 75 - 150 - 250 mm
3	Wobble extensions	5238 3/8" EXW 75 - 150 - 250 mm
1	Adaptor	5738 3/8" A
1	Adaptor	5638 3/8" A
1	Universal joint	5838 3/8" U
1	Sliding T-handle	5438 3/8" TH
1	Ratchet, 60 teeth	5338 3/8" E
3	Socket drivers for slotted head screws	5112 1/2" 8 - 10 - 12 mm
2	Socket drivers for Phillips® screws	5112 1/2" PH 3 - 4
2	Socket drivers for Pozidriv® screws	5112 1/2" PZ 3 - 4
9	Socket drivers for hex head screws	5112 1/2" H 5 - 6 - 7 - 8 - 10 - 12 - 14 - 17 - 19 mm
9	Socket drivers for Torx® screws	5112 1/2" TX T20 - T25 - T27 - T30 - T40 - T45 - T50 - T55 - T60
9	Socket for Torx® screws	5012 1/2" NTX E10 - E11 - E12 - E14 - E16 - E18 - E20 - E22 - E24
1	Universal joint	5812 1/2" U
1	Adaptor	5712 1/2" A
1	Ratchet, 60 teeth	5312 1/2" E
7	Long bits for slotted head screws	4614 1/4" 3 - 4 - 5 - 6 - 7 - 8 - 10 mm
3	Long bits for Phillips® screws	4614 1/4" ACR PH 1 - 2 - 3
3	Long bits for Pozidriv® screws	4614 1/4" ACR PZ 1 - 2 - 3
7	Long bits for Tamper Resistant® Torx® screws	4614 1/4" STX T10 - T15 - T20 - T25 - T25 - T27 - T30 - T40
1	Torque-wrench	7114 1/4" 4-20 Nm
1	Torque-wrench	7138 3/8" 20-120 Nm

SOCKET WRENCH SET, TORQUE WRENCH



CONTENT: (Item no. 1875-0470-3)

QTY.	DESCRIPTION	SIZE
24	6-point sockets	5012 1/2" 8 - 9 - 10 - 11 - 12 - 13 - 14 - 15 - 16 - 17 - 18 - 19 - 20 - 21 - 22 - 23 - 24 - 25 - 26 - 27 - 28 - 29 - 30 - 32 mm
14	Long 6-point sockets	5012 1/2" L 10 - 11 - 12 - 13 - 14 - 15 - 16 - 17 - 18 - 19 - 20 - 21 - 22 - 24 mm
9	Long socket drivers for hex head screws	5112 1/2" HL 5 - 6 - 7 - 8 - 10 - 12 - 14 - 17 - 19 mm
9	Long socket drivers for Torx® screws	5112 1/2" TXL T20 - T25 - T27 - T30 - T40 - T45 - T50 - T55 - T60
3	Extensions	5212 1/2" EX 75 - 125 - 250 mm
3	Wobble extensions	5212 1/2" EXW 75 - 125 - 250 mm
1	Swivel handle	5912 1/2" FH 410 mm
1	Sliding T-handle	5412 1/2" TH
1	Ratchet, 60 teeth	5312 1/2" E
1	Torque-wrench	7112 1/2" 60-340 NM
2	Spark plug sockets	5038 3/8" SP 16 - 21 mm

SCREWDRIVER SET



CONTENT: (Item no. 1875-0470-1)

QTY.	DESCRIPTION	SIZE
6	Screwdrivers for slotted screws	4000 3x75 - 4x100 - 5,5x125 - 6,5x150 - 8x175 - 10x200 mm
2	Stubby screwdrivers for slotted screws	4003 5,5x25 - 6,5x25 mm
4	Screwdrivers for Phillips® screws	4010 PH 0 - 1 - 2 - 3
2	Stubby screwdrivers for Phillips® screws	4013 PH 1 - 2
3	Screwdrivers for Pozidriv® screws	4020 PZ 1 - 2 - 3
2	Stubby screwdrivers for Pozidriv® screws	4023 PZ 1 - 2
8	Screwdrivers for Torx® screws	4031 TX T8 - T10 - T15 - T20 - T25 - T25 - T30 - T40
3	Flexible hexagonal nut drivers	4042 F 1/4" - 6 - 7 mm
1	Magnetic bit holding screwdriver	4043 M 1/4"

POLAR® ROLLER CABINETS, ASSORTMENTS AND STORAGE

COMB. AND DOUBLE SWIVEL END SOCKET WRENCHES, REVERSIBLE GEAR COMB. WRENCHES



CONTENT: (Item no. 1875-0470-4)

QTY.	DESCRIPTION	SIZE
26	Combination wrenches	2000 6 - 7 - 8 - 9 - 10 - 11 - 12 - 13 - 14 - 15 - 16 - 17 - 18 - 19 - 20 - 21 - 22 - 23 - 24 - 25 - 26 - 27 - 28 - 29 - 30 - 32 mm
12	Reversible gear combination wrenches	2005 8 - 9 - 10 - 11 - 12 - 13 - 14 - 15 - 16 - 17 - 18 - 19 mm
7	Offset combination wrenches	2100 8 - 10 - 12 - 13 - 15 - 17 - 19 mm
6	Double swivel end socket wrenches	2400 8x9 - 10x11 - 12x13 - 14x15 - 16x17 - 18x19 mm

BITS, HAMMERS AND IMPACT TOOLS



CONTENT: (Item no. 1875-0470-7)

QTY.	DESCRIPTION	SIZE
1	Engineers hammer, 300 g	8030 300 g
1	Sledge hammer 1000 g	8040 1000 g
1	Dead blow hammer, 30 mm	8060 35 mm
6	Pin punches	8200 2 - 3 - 4 - 5 - 6 - 8 mm
5	Taper punches	8205 2 - 3 - 4 - 5 - 6 mm
2	Center punches	8210 sizes 3 - 4
2	Cape chisels	8215 5 - 7 mm
2	Flat cold chisels	8220 12 - 18 mm
1	Magnetic pick-up tool	9000 2,2 kg
1	Magnetic bit holding screwdriver	4043 1/4" M
1	Quick-Release screwdriver bit socket	4714 1/4" QR
1	Screwdriver bit socket	4714 1/4"
1	Socket adaptor	4714 1/4" SQ 25 mm
5	Bits for slotted head screws	4514 1/4" 3.5 - 4.5 - 5.5 - 6.5 - 8 mm
3	Bits for Phillips® screws	4514 1/4" ACR PH 1 - 2 - 3
3	Bits for Pozidriv® screws	4514 1/4" ACR PZ 1 - 2 - 3
7	Bits for Torx® screws	4514 1/4" TX T10 - T15 - T20 - T25 - T27 - T30 - T40
9	Bits for Tamper Resistant® Torx® head screws	4514 1/4" STX T8 - T9 - T10 - T15 - T20 - T25 - T27 - T30 - T40
7	Bits for hex head bore hole screws	4514 1/4" HB 2 - 2.5 - 3 - 4 - 5 - 6 - 8 mm
1	Bits for square head screws	4514 1/4" SQ 2
5	Bits for spanner screws	4514 1/4" SN 4 - 6 - 8 - 10 - 12
4	Bits for Torq-Set® screws	4514 1/4" TS 6 - 8 - 10 mm / 1/4"
3	Bits for XZN screws	4514 1/4" XZN 5 - 6 - 8
4	Bits for Tri-Wing® screws	4514 1/4" TW 2 - 3 - 4 - 5
1	Bits for hooks	4514 1/4" HOOK

IMPACT DRIVER, ADJUSTABLE WRENCHES, HEXAGONAL KEYS, FILES AND MEASURING TOOLS



CONTENT: (Item no. 1875-0470-6)

QTY.	DESCRIPTION	SIZE
9	Long angled Torx® keys	4190 LTXS/9 T8 - T10 - T15 - T20 - T25 - T27 - T30 - T40 - T50
9	Long angled ball-point hexagon keys	4195 LS/9 1,5 - 2 - 2,5 - 3 - 4 - 5 - 6 - 8 - 10 mm
8	Foldable ball-point key set for hex head screws	4195 FS/8 1,5 - 2 - 2,5 - 3 - 4 - 5 - 6 - 8 mm
8	Foldable key set for Torx® screws	4190 FTXS/8 T9 - T10 - T15 - T20 - T25 - T27 - T30 - T40
4	Adjustable wrenches	2600 6" - 8" - 10" - 12"
1	Vernier caliper	9200 150 mm
1	Measuring tape	9400 3 mtr.
1	Flat file	3900 200 mm
1	Round file	3901 200 mm
1	Halfround file	3902 200 mm
1	Square file	3903 200 mm
1	Triangular file	3904 200 mm
3	Bits for slotted head screws	4516 5/16" 8 - 10 - 12 mm
3	Bits for Phillips® screws	4516 5/16" ACR PH 2 - 3 - 4
4	Bits for Torx® screws	4516 5/16" TX T40 - T45 - T50 - T55
5	Bits for hex head screws	4516 5/16" H 5 - 6 - 8 - 10 - 12 mm
1	Screwdriver bit socket	4712 1/2" x 5/16"
1	Impact bit driver	4712 1/2" ID

PLIERS, CIRCLIPS PLIERS AND CUTTING TOOLS



CONTENT: (Item no. 1875-0470-5)

QTY.	DESCRIPTION	SIZE
1	Combination plier	3001 180 mm
1	Long nose plier	3005 160 mm
1	Bent nose plier	3006 160 mm
1	Diagonal plier	3002 160 mm
1	Water pump plier	3020 250 mm
1	Internal circlip plier, straight	3100 180 mm - Ø19 - 60 mm
1	Internal circlip plier, bent	3105 180 mm - Ø19 - 60 mm
1	External circlip plier, straight	3110 180 mm - Ø19 - 60 mm
1	External circlip plier, bent	3115 180 mm - Ø19 - 60 mm
1	Locking plier, curved jaw, w/wire cutter	3200 180 mm
1	Tinmans shears (straight)	3410 250 mm
1	Electronic scissor	3500 140 mm - 3,0 mm
1	Knife	9105 18 mm
1	Junior hacksaw	9210 150 mm
1	Wire stripper	3009 160 mm

POLAR® ROLLER CABINETS, ASSORTMENTS AND STORAGE

1875 S4 TOOL SET - 66 TOOLS

ITEM NO. 18750066

5704196 018560

9,3 KG

SUITABLE FOR

MINI - page 46
TOOL BOX A2 - page 23



CONTENT:

QTY.	DESCRIPTION	SIZE
18	6-point sockets	5012 1/2" 10 - 11 - 12 - 13 - 14 - 15 - 16 - 17 - 18 - 19 - 20 - 21 - 22 - 23 - 24 - 27 - 30 - 32 mm
1	Ratchet, 60 teeth	5312 E 1/2"
2	Extensions	5212 1/2" EX 125 - 250 mm
1	Sliding T-handle	5412 1/2" TH
1	Universal joint	5812 1/2" U
4	Screwdrivers for slotted head screws	4000 3x75 - 4x100 - 5,5x125 - 6,5x150 mm
3	Screwdrivers for Phillips® screws	4010 PH 1 - PH 2 - PH 3
14	Combination wrenches	2000 8 - 9 - 10 - 11 - 12 - 13 - 14 - 15 - 16 - 17 - 18 - 19 - 21 - 22 mm
1	Combination plier	3001 180 mm
1	Diagonal cutter	3002 160 mm
1	Half-round long nose plier	3005 160 mm
1	Waterpump plier	3020 250 mm
1	Locking plier	3202 250 mm
1	Electricians scissor	3500 140 mm
9	Long metric hexagon keys	4105 BP 1.5 - 2 - 2.5 - 3 - 4 - 5 - 6 - 8 - 10 mm
1	Mechanics hammer	8030 300 g
1	Taper punch	8205 3 x 120 mm
1	Center punch	8210 2 x 120 mm
1	Cape chisel	8215 5 x 130 mm
1	Flat chisel	8220 12 x 130 mm
1	Pin punch	8200 4 x 150 mm
1	Hacksaw	9210 300 mm



POLAR®

polar®

1875 S5 TOOL SET - 163 TOOLS

ITEM NO. 18750163

5704196 020273

26 KG

SUITABLE FOR

EASY - page 47

CARGO - page 32-33

163
TOOLS



CONTENT:

- 1800 Combination wrench set 8 - 19 mm
- 1801 Combination wrench set 20 - 24 mm
- 1814 1/4" Socket wrench set 4 - 14 mm
- 1819 1/2" Socket wrench set 10 - 32 mm
- 1827 1/2" Ratchet and accessories
- 1829 B Screwdriver set for slotted head screws
- 1830 C Screwdriver set, PH
- 1831 A Screwdriver set, TX
- 1834 Metric and Torx® hexagon key set
- 1835 Plier set with combination-, cutting- and long nose plier
- 1836 Plier set with waterpump- and locking plier
- 1845 Measuring and cutting toolset

POLAR® ROLLER CABINETS, ASSORTMENTS AND STORAGE

1875 S6 TOOL SET - 473 TOOLS

ITEM NO. 18750473

5704196 018638

53 KG

SUITABLE FOR

X-LARGE - page 50-51

**473
TOOLS**

METRIC SOCKETS, SOCKET DRIVERS AND ACCESSORIES, TORQUE WRENCHES



CONTENT: (Item no. 1875-0470-2)

QTY.	DESCRIPTION	SIZE
13	6-point sockets	5014 1/4" 4 - 4,5 - 5 - 5,5 - 6 - 7 - 8 - 9 - 10 - 11 - 12 - 13 - 14 mm
11	Long 6-point sockets	5014 1/4" L 4 - 5 - 5,5 - 6 - 7 - 8 - 9 - 10 - 11 - 12 - 13 - mm
3	Socket drivers for slotted head screws	5114 1/4" 4 - 5,5 - 7 mm
3	Socket drivers for Phillips® screws	5114 1/4" PH 1 - 2 - 3
3	Socket drivers for Pozidriv® screws	5114 1/4" PZ 1 - 2 - 3
6	Socket drivers for hex head screws	5114 1/4" H 3 - 4 - 5 - 6 - 7 - 8 mm
7	Socket drivers for Tamper Resistant® Torx® screws	5114 1/4" STX T10 - T15 - T20 - T25 - T27 - T30 - T40
6	Socket for Torx® screws	5014 1/4" NTX E4 - E5 - E6 - E7 - E8 - E10
1	Screwdriver bit socket	4714 1/4" x 1/4"
3	Extensions	5214 1/4" EX 50 - 100 - 150 mm
1	Flexible extension	5214 1/4" F 150 mm
1	Adaptor	5614 1/4" A
1	Universal joint	5814 1/4" U
1	Sliding T-handle	5414 1/4" TH
1	Spinner handle	5514 1/4" HD
1	Ratchet, 60 teeth	5314 1/4" E
17	6-point sockets	5038 3/8" 6 - 7 - 8 - 9 - 10 - 11 - 12 - 13 - 14 - 15 - 16 - 17 - 18 - 19 - 20 - 21 - 22 mm
14	Long 6-point sockets	5038 3/8" L 8 - 9 - 10 - 11 - 12 - 13 - 14 - 15 - 16 - 17 - 18 - 19 - 21 - 22 mm
3	Extensions	5238 3/8" EX 75 - 150 - 250 mm
3	Wobble extensions	5238 3/8" EXW 75 - 150 - 250 mm
1	Adaptor	5738 3/8" A
1	Adaptor	5638 3/8" A
1	Universal joint	5838 3/8" U
1	Sliding T-handle	5438 3/8" TH
1	Ratchet, 60 teeth	5338 3/8" E
3	Socket drivers for slotted head screws	5112 1/2" 8 - 10 - 12 mm
2	Socket drivers for Phillips® screws	5112 1/2" PH 3 - 4
2	Socket drivers for Pozidriv® screws	5112 1/2" PZ 3 - 4
9	Socket drivers for hex head screws	5112 1/2" H 5 - 6 - 7 - 8 - 10 - 12 - 14 - 17 - 19 mm
9	Socket drivers for Torx® screws	5112 1/2" TX T20 - T25 - T27 - T30 - T40 - T45 - T50 - T55 - T60
9	Socket for Torx® screws	5012 1/2" NTX E10 - E11 - E12 - E14 - E16 - E18 - E20 - E22 - E24
1	Universal joint	5812 1/2" U
1	Adaptor	5712 1/2" A
1	Ratchet, 60 teeth	5312 1/2" E
7	Long bits for slotted head screws	4614 1/4" 3 - 4 - 5 - 6 - 7 - 8 - 10 mm
3	Long bits for Phillips® screws	4614 1/4" ACR PH 1 - 2 - 3
3	Long bits for Pozidriv® screws	4614 1/4" ACR PZ 1 - 2 - 3
7	Long bits for Tamper Resistant® Torx® screws	4614 1/4" STX T10 - T15 - T20 - T25 - T25 - T27 - T30 - T40
1	Torque-wrench	7114 1/4" 4-20 Nm
1	Torque-wrench	7138 3/8" 20-120 Nm

SOCKET WRENCH SET, TORQUE WRENCH



CONTENT: (Item no. 1875-0470-3)

QTY.	DESCRIPTION	SIZE
24	6-point sockets	5012 1/2" 8 - 9 - 10 - 11 - 12 - 13 - 14 - 15 - 16 - 17 - 18 - 19 - 20 - 21 - 22 - 23 - 24 - 25 - 26 - 27 - 28 - 29 - 30 - 32 mm
14	Long 6-point sockets	5012 1/2" L 10 - 11 - 12 - 13 - 14 - 15 - 16 - 17 - 18 - 19 - 20 - 21 - 22 - 24 mm
9	Long socket drivers for hex head screws	5112 1/2" HL 5 - 6 - 7 - 8 - 10 - 12 - 14 - 17 - 19 mm
9	Long socket drivers for Torx® screws	5112 1/2" TXL T20 - T25 - T27 - T30 - T40 - T45 - T50 - T55 - T60
3	Extensions	5212 1/2" EX 75 - 125 - 250 mm
3	Wobble extensions	5212 1/2" EXW 75 - 125 - 250 mm
1	Swivel handle	5912 1/2" FH 410 mm
1	Sliding T-handle	5412 1/2" TH
1	Ratchet, 60 teeth	5312 1/2" E
1	Torque-wrench	7112 1/2" 60-340 NM
2	Spark plug sockets	5038 3/8" SP 16 - 21 mm

SCREWDRIVER SET



CONTENT: (Item no. 1875-0470-1)

QTY.	DESCRIPTION	SIZE
6	Screwdrivers for slotted screws	4000 3x75 - 4x100 - 5,5x125 - 6,5x150 - 8x175 - 10x200 mm
2	Stubby screwdrivers for slotted screws	4003 5,5x25 - 6,5x25 mm
4	Screwdrivers for Phillips® screws	4010 PH 0 - 1 - 2 - 3
2	Stubby screwdrivers for Phillips® screws	4013 PH 1 - 2
3	Screwdrivers for Pozidriv® screws	4020 PZ 1 - 2 - 3
2	Stubby screwdrivers for Pozidriv® screws	4023 PZ 1 - 2
8	Screwdrivers for Torx® screws	4031 TX T8 - T10 - T15 - T20 - T25 - T25 - T30 - T40
3	Flexible hexagonal nut drivers	4042 F 1/4" - 6 - 7 mm
1	Magnetic bit holding screwdriver	4043 M 1/4"

POLAR® ROLLER CABINETS, ASSORTMENTS AND STORAGE

COMB. AND DOUBLE SWIVEL END SOCKET WRENCHES, REVERSIBLE GEAR COMB. WRENCHES



CONTENT: (Item no. 1875-0470-8)

QTY.	DESCRIPTION	SIZE
26	Combination wrenches	2000 6 - 7 - 8 - 9 - 10 - 11 - 12 - 13 - 14 - 15 - 16 - 17 - 18 - 19 - 20 - 21 - 22 - 23 - 24 - 25 - 26 - 27 - 28 - 29 - 30 - 32 mm
12	Reversible gear combination wrenches	2005 8 - 9 - 10 - 11 - 12 - 13 - 14 - 15 - 16 - 17 - 18 - 19 mm
8	Double open end wrenches	2010 6x7 - 8x9 - 10x11 - 12x13 - 14x15 - 16x17 - 18x19 - 20x22 mm
8	Double end offset ring wrenches	2110 6x7 - 8x9 - 10x11 - 12x13 - 14x15 - 16x17 - 18x19 - 20x22 mm

BITS, HAMMERS AND IMPACT TOOLS



CONTENT: (Item no. 1875-0470-7)

QTY.	DESCRIPTION	SIZE
1	Engineers hammer, 300 g	8030 300 g
1	Sledge hammer, 1000 g	8040 1000 g
1	Dead blow hammer, 30 mm	8060 35 mm
6	Pin punches	8200 2 - 3 - 4 - 5 - 6 - 8 mm
5	Taper punches	8205 2 - 3 - 4 - 5 - 6 mm
2	Center punches	8210 sizes 3 - 4
2	Cape chisels	8215 5 - 7 mm
2	Flat cold chisels	8220 12 - 18 mm
1	Magnetic pick-up tool	9000 2,2 kg
1	Magnetic bit holding screwdriver	4043 1/4" M
1	Quick-Release screwdriver bit socket	4714 1/4" QR
1	Screwdriver bit socket	4714 1/4"
1	Socket adaptor	4714 1/4" SQ 25 mm
5	Bits for slotted head screws	4514 1/4" 3.5 - 4.5 - 5.5 - 6.5 - 8 mm
3	Bits for Phillips® screws	4514 1/4" ACR PH 1 - 2 - 3
3	Bits for Pozidriv® screws	4514 1/4" ACR PZ 1 - 2 - 3
7	Bits for Torx® screws	4514 1/4" TX T10 - T15 - T20 - T25 - T27 - T30 - T40
9	Bits for Tamper Resistant® Torx® head screws	4514 1/4" STX T8 - T9 - T10 - T15 - T20 - T25 - T27 - T30 - T40
7	Bits for hex head bore hole screws	4514 1/4" HB 2 - 2.5 - 3 - 4 - 5 - 6 - 8 mm
1	Bits for square head screws	4514 1/4" SQ 2
5	Bits for spanner screws	4514 1/4" SN 4 - 6 - 8 - 10 - 12
4	Bits for Torq-Set® screws	4514 1/4" TS 6 - 8 - 10 mm / 1/4"
3	Bits for XZN screws	4514 1/4" XZN 5 - 6 - 8
4	Bits for Tri-Wing® screws	4514 1/4" TW 2 - 3 - 4 - 5
1	Bits for hooks	4514 1/4" HOOK

IMPACT DRIVER, ADJUSTABLE WRENCHES, HEXAGONAL KEYS, FILES AND MEASURING TOOLS



CONTENT: (Item no. 1875-0470-6)

QTY.	DESCRIPTION	SIZE
9	Long angled Torx® keys	4190 LTXS/9 T8 - T10 - T15 - T20 - T25 - T27 - T30 - T40 - T50
9	Long angled ball-point hexagon keys	4195 LS/9 1.5 - 2 - 2.5 - 3 - 4 - 5 - 6 - 8 - 10 mm
8	Foldable ball-point key set for hex head screws	4195 FS/8 1.5 - 2 - 2.5 - 3 - 4 - 5 - 6 - 8 mm
8	Foldable key set for Torx® screws	4190 FTXS/8 TX T9 - T10 - T15 - T20 - T25 - T27 - T30 - T40
4	Adjustable wrenches	2600 6" - 8" - 10" - 12"
1	Vernier caliper	9200 150 mm
1	Measuring tape	9400 3 mtr.
1	Flat file	3900 200 mm
1	Round file	3901 200 mm
1	Halfround file	3902 200 mm
1	Square file	3903 200 mm
1	Triangular file	3904 200 mm
3	Bits for slotted head screws	4516 5/16" 8 - 10 - 12 mm
3	Bits for Phillips® screws	4516 5/16" ACR PH 2 - 3 - 4
4	Bits for Torx® screws	4516 5/16" TX T40 - T45 - T50 - T55
5	Bits for hex head screws	4516 5/16" H 5 - 6 - 8 - 10 - 12 mm
1	Screwdriver bit socket	4712 1/2" x 5/16"
1	Impact bit driver	4712 1/2 ID

PLIERS, CIRCLIPS PLIERS AND CUTTING TOOLS



CONTENT: (Item no. 1875-0470-5)

QTY.	DESCRIPTION	SIZE
1	Combination plier	3001 180 mm
1	Long nose plier	3005 160 mm
1	Bent nose plier	3006 160 mm
1	Diagonal plier	3002 160 mm
1	Water pump plier	3020 250 mm
1	Internal circlip plier, straight	3100 180 mm - Ø19 - 60 mm
1	Internal circlip plier, bent	3105 180 mm - Ø19 - 60 mm
1	External circlip plier, straight	3110 180 mm - Ø19 - 60 mm
1	External circlip plier, bent	3115 180 mm - Ø19 - 60 mm
1	Locking plier, curved jaw, w/wire cutter	3200 180 mm
1	Tinmans shears (straight)	3410 250 mm
1	Electronic scissor	3500 140 mm - 3,0 mm
1	Knife	9105 18 mm
1	Junior hacksaw	9210 150 mm
1	Wire stripper	3009 160 mm



POLAR® ROLLER CABINETS, ASSORTMENTS AND STORAGE

1875 S7 TOOL SET - 447 TOOLS

ITEM NO. 18750447

5704196 020266

55 KG

SUITABLE FOR

X-LARGE - page 54-55

447
TOOLS

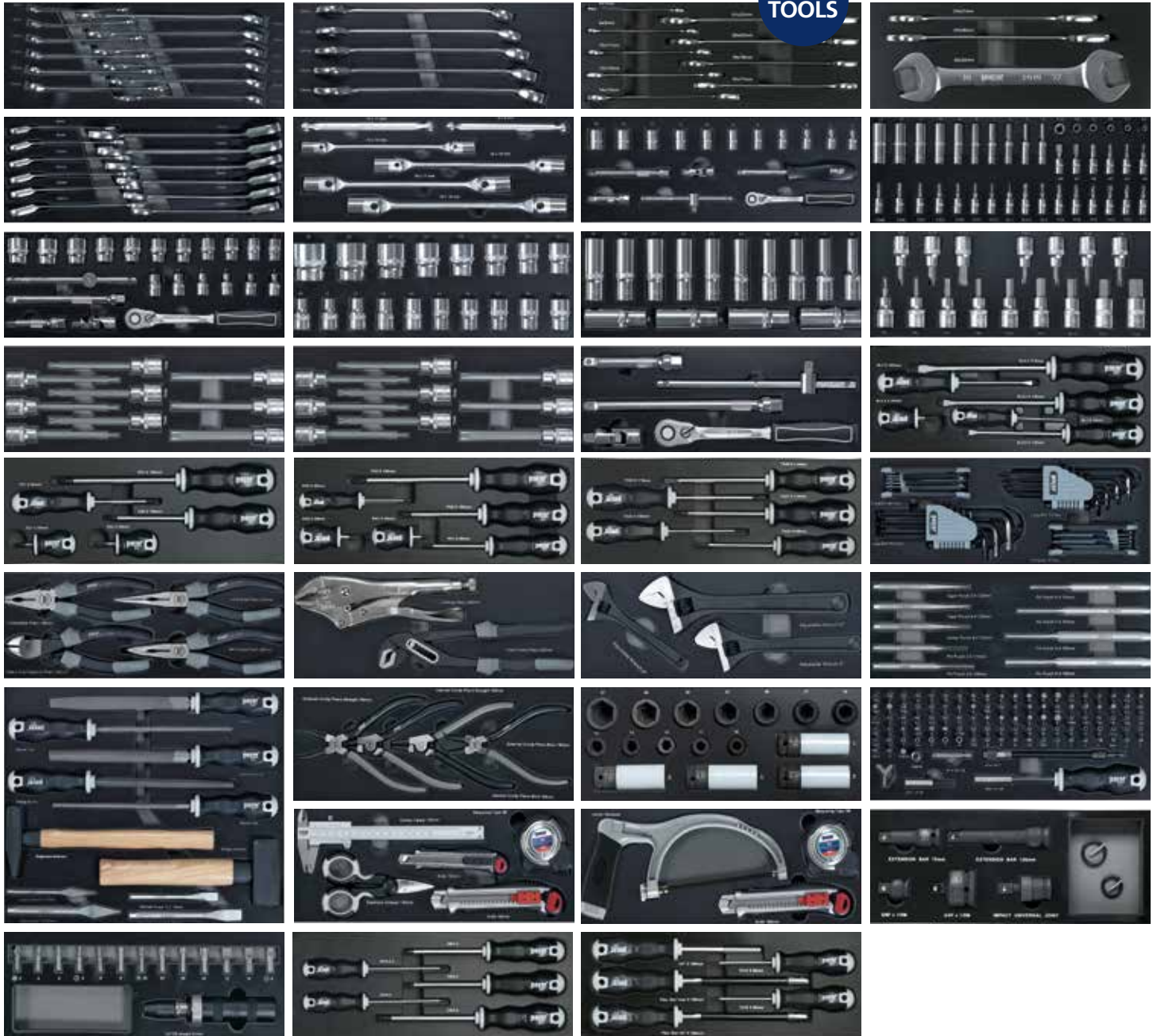

CONTENT:

1800 Combination wrench set 8 - 19 mm
1801 Combination wrench set 20 - 24 mm
1805 A Metric double open end wrench set 6-23 mm
1805 B Metric double open end wrench set 24-32 mm
1807 Reversible ratchet combination wrench set 8 - 19 mm
1812 Double swivel end socket wrench set 8 - 19 mm
1813 1/4" Socket wrench set 4 - 14 mm
1815 1/4" Long sockets and socket drivers

1817 3/8" Socket wrench set 6 - 22 mm
1819 1/2" Socket wrench set 10 - 32 mm
1820 1/2" Long sockets 10 - 24 mm
1824 1/2" Socket drivers for slot-head, Phillips®, Pozidriv® and hexagonal screws
1825 1/2" Long socket drivers for hex head screws 5-19 mm
1826 1/2" Long socket drivers for Torx® screws T10 - T50
1827 1/2" Ratchet and accessories

1829 B Screwdriver set for slotted head screws
1830 C Screwdriver set, PH
1830 B Screwdriver set, PZ
1831 A Screwdriver set, TX
1834 Metric and Torx® hexagon key set
1835 Plier set with combination-, cutting- and long nose pliers
1836 Plier set with waterpump- and locking pliers

1837 Adjustable wrenches 6" - 8" - 10"
1839 Hammers, chisels and files set
1840 Impact tool set
1841 Plier set for circlips 19 - 60 mm
1842 1/2" Impact socket set
1843 Bits set
1844 Measuring and cutting tool set
1845 Measuring and cutting tool set

1846 Impact accessories
1847 Impact driver bit set
1848 Screwdriver set, hex
1849 Screwdriver set

POLAR® ROLLER CABINETS, ASSORTMENTS AND STORAGE

1100 WALLMOUNTED CABINETS

- Perforated panels with round holes Ø 4 mm.
- Surface: Black powder coating.
- Large program in hooks and holders



ITEM NO.	5704196+	H MM	W MM	D MM	KG	
11000261	011783	800	600	240	16,5	1

1110 TOOL PANELS

- Perforated panels with round holes Ø 4 mm.
- Surface: Black powder coating.
- Large program in hooks and holders

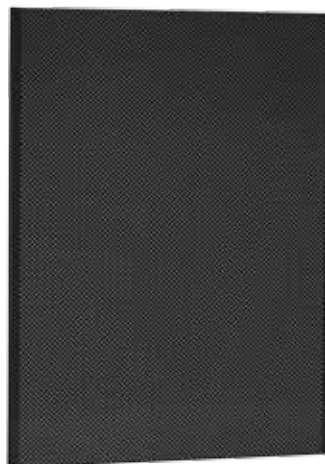

ITEM NO.	5704196+	H MM	W MM	KG	
11100305	011806	475	950	4	1
11100310	011813	950	950	8	1
11100312	011820	750	1050	7	1
11100315	011837	950	1450	12	1

1110 WALL MOUNTING UNIT

- To be used for tool panel mounting.



ITEM NO.	5704196+	L MM	KG	
11100324	011844	100	90	1

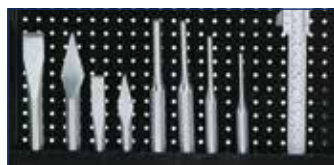

POLAR® ROLLER CABINETS, ASSORTMENTS AND STORAGE

TOOL HOLDERS

1120 TOOL HOLDERS

- Holder for wrenches and adjustable wrenches etc.



ITEM NO.	5704196+	Ø MM	L MM	G	
11200702	011868	5	30	9	1
11200703	011875	5	42	10	1
11200705	011882	5	100	19	1

1120 TOOL HOOKS

- Hook for wrenches and adjustable wrenches etc.



ITEM NO.	5704196+	Ø MM	L MM	G	
11200704	011882	5	30	9	1
11200706	011905	5	44	12	1

1120 TOOL HOOKS

- Hook for heavy tools.



ITEM NO.	5704196+	Ø MM	L MM	G	
11200707	011912	6	75	52	1
11200708	011929	8	140	95	1
11200709	011936	8	190	115	1
11200710	011943	6	30	43	1
11200711	011950	6	100	58	1

1120 TOOL HOOKS

- Bent hook.



ITEM NO.	5704196+	L MM	G	
11200721	011998	35	14	1
11200722	012001	45	17	1

1120 TOOL HOOK

- Strong bent hook.



ITEM NO.	5704196+	L MM	G	
11200726	012018	105	62	1

1120 TOOL HOLDERS

- Holder for sockets.



ITEM NO.	5704196+	Ø	G	
11200733	012063	3/8"	11	1
11200734	012070	1/2"	15	1
11200735	012087	3/4"	29	1

1120 TOOL HOOKS

- Double hook for files and hammers etc.



ITEM NO.	5704196+	INT. DIST.	G	
11200727	012025	12 mm	25	1
11200730	012032	18 mm	28	1
11200732	012056	23 mm	30	1

1120 SPRING CLIPS

- Spring clips for various tools.



ITEM NO.	5704196+	Ø MM	G	
11200744	029470	19	2	1
11200745	029702	25	4	1
11200746	029719	28	6	1
11200747	029726	32	6	1
11200748	029733	38	8	1

1120 TOOL HOLDER

▪ Holder for spraycans.



ITEM NO.	5704196+	INT. Ø MM	G	
11200794	012490	80	95	1

1120 SCREWS



ITEM NO.	5704196+	QTY.	DIMENSION	G	
11200796	012469	100	4,8 x 6,5 mm	180	1

1125 ASSORTMENTS WITH HOOKS AND HOLDERS

▪ Hooks and holders incl. screws.



ITEM NO.	5704196+	QTY.	G	
11250700	012476	65	2,2	1
11250702	012483	100	3,0	1



POLAR® ROLLER CABINETS, ASSORTMENTS AND STORAGE



WORKBENCH

POLAR® workbenches are constructed in a heavy duty version in order to meet your requirements for a complete workstation.

Material: 3 mm sheet steel.

Worktop in 15 mm hard PVC material.

Construction:
1000 kg static load

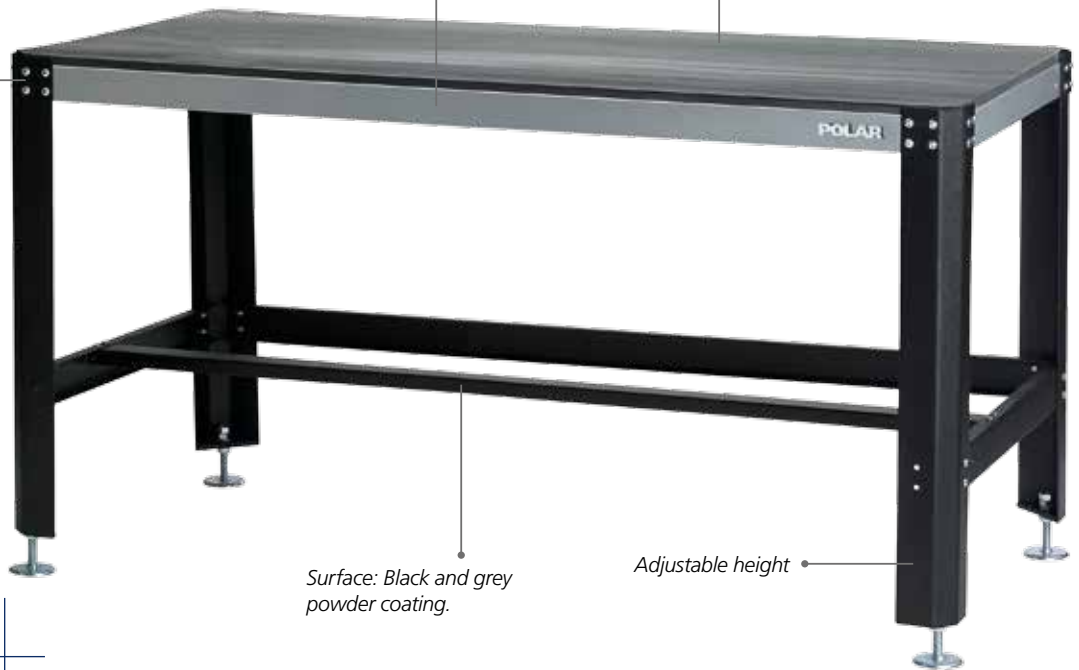

Surface: Black and grey powder coating.

Adjustable height

1300 WORKBENCH, 1500 MM

ITEM NO. 13001500

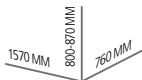

41 KG

5704196 013602

IMPA CODE 613886

1340 TOOL CABINET WITH PERFORATED PANEL

ITEM NO. 13401500

5704196 013619

HxWxD 600x1570x205 mm

42 KG



- With security lock.
- Perforated panel with round holes Ø 4 mm.
- Surface: Grey powder coating.
- Easy to mount on the workbench (legs and screws included).

1345 PERFORATED TOOL PANEL

ITEM NO. 13451500

5704196 013626

HxWxD 590 x 1350 x 15 mm

14 KG

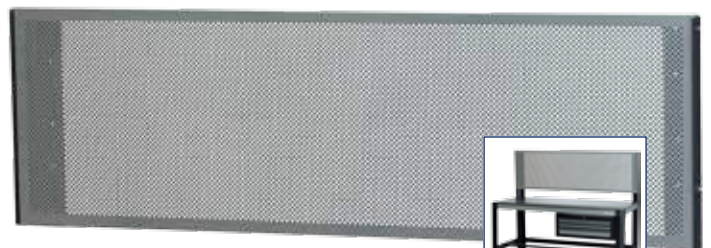

- Perforated panel with round holes Ø 4 mm.
- Surface: Grey powder coating.
- Easy to mount on the workbench (legs and screws included).

POLAR® ROLLER CABINETS, ASSORTMENTS AND STORAGE

1000 5D MINI ROLLER CABINET (EMPTY)

ITEM NO. 10003005

5704196 016863 HxWxD 780 x 575 (645) x 340 mm 35 KG 1



- Low model which can be stored under the workbench.
- Worktop in hard PVC material, chemical resistant.
- 5 drawers mounted on ball bearing slides.
- All drawers are supplied with oil-proof rubber mats.
- Centralized locking.
- 2 swivelling wheels with brakes.
- 200 kg static load. Drawer loading capacity: 30 kg
- Oil-proof nylon wheels: Ø 100 mm
- 3 drawers: H 65 x W 470 x D 290 mm
- 2 drawers: H 145 x W 470 x D 290 mm
- Surface: Black and grey powder coating.
- Material: 1,2 mm sheet steel casing.

! Also available with tool set S4 - see page 46.

1355 3D DRAWER CHEST

ITEM NO. 13550003

5704196 027654 HxWxD 270 x 670 x 430 mm 20 KG 1



- 3 drawers mounted on ball bearing slides.
- All drawers are supplied with oil-proof rubber mats.
- Centralized locking.
- Drawer loading capacity: 30 kg
- 2 drawers: H 48 x B 570 x D 380 mm
- 1 drawer: H 65 x B 570 x D 380 mm
- Surface: Black and grey powder coating.
- Material: 1,2 mm sheet steel casing.
- Easy to mount on the workbench (*screws and brackets included*).

1200 SERVICE CART

ITEM NO. 12000003

5704196 013596 HxWxD 1040 x 760 (910) x 490 mm 12 KG 1



- Lightweight construction in aluminium with 3 shelves and handles made of PVC material.
- 4 swivelling wheels - 2 with brakes.
- Shelf loading capacity: 50 kg
- Oil-proof rubber wheels: Ø 100 mm
- 3 shelves: W 700 x D 440 mm

1200 FOLDING TROLLEY

ITEM NO. 12000001

5704196 028262

HxWxD 840 x 810 x 500 mm

10,8 KG

1



- Practical trolley for moving heavy things.
- Thickness of platform: 40 mm
- Loading capacity: 300 kg

1202 DOLLY WITH CARRYING HANDLE

ITEM NO. 12020001

5704196 030388

HxWxD 145 x 665 x 455 mm

5,4 KG

1



- Built-in hand grip for easy transportation.
- 2 swivelling wheels with brakes.
- Thickness of platform: 32 mm
- Loading capacity: 300 kg





POLAR® WRENCHES

WRENCHES

POLAR® Wrenches are manufactured according to international standards, giving you the professional quality known by POLAR® products. Our wrenches have a perfect fit and ensures great comfort, giving you a slim design, which facilitates working in confined spaces.

- Combination wrenches
- Combination wrenches offset
- Reversible gear combination wrenches
- Double open end wrenches
- Double socket ratchet wrenches
- Double end offset ring wrenches
- Flare nut wrenches
- Double swivel end socket wrenches
- Swivel gear combination wrenches
- Adjustable wrenches



Polished heads and compact design

Slim ergonomic profile

Max. torque profile





WRENCHES

2000 METRIC COMBINATION WRENCHES

ISO 3318, DIN 3113.

- 12-Point ring angled at 15°. Open end angled at 15°.
- Surface: Satin chrome finish. Material: Chrome-vanadium steel.

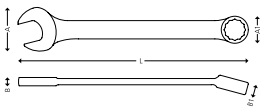

ITEM NO.	5704196+	SIZE MM	A MM	A1 MM	B MM	B1 MM	L MM	G G	IMPA CODE
W 20000006	000015	6	15,5	10,1	4,0	4,7	105	17	610761
W 20000007	000022	7	17,0	11,5	4,0	5,0	115	20	610762
W 20000008	000039	8	19,2	12,8	4,5	5,5	125	26	610763
W 20000009	000046	9	21,2	14,2	4,7	5,9	135	34	610764
W 20000010	000053	10	23,2	15,6	5,0	6,5	145	36	610765
W 20000011	000060	11	25,3	16,9	5,4	6,9	155	44	610766
W 20000012	000077	12	27,2	18,3	5,5	7,3	165	52	610767
W 20000013	000084	13	29,4	19,7	5,9	7,8	175	63	610768
W 20000014	000091	14	31,5	21,2	6,2	8,3	185	78	610769
W 20000015	000107	15	33,2	22,5	6,4	8,6	195	94	610792
W 20000016	000114	16	34,7	24,0	6,7	8,9	205	106	610770
W 20000017	000121	17	36,5	25,3	6,9	9,3	215	132	610771
W 20000018	000138	18	38,7	26,8	7,2	9,9	225	144	610793
W 20000019	000145	19	40,7	28,1	7,4	10,5	235	154	610772
W 20000020	000152	20	43,1	29,7	7,7	10,9	245	188	610794
W 20000021	000169	21	44,8	31,3	8,1	11,6	255	200	610773
W 20000022	000176	22	46,9	32,6	8,2	11,5	265	220	610774
W 20000023	000183	23	48,3	34,2	8,4	11,8	275	260	610775
W 20000024	000190	24	50,4	35,5	8,7	12,1	285	280	610775
W 20000025	000206	25	52,0	36,9	8,9	12,5	295	300	610795
W 20000026	000213	26	53,6	38,2	9,2	12,8	305	320	610777
W 20000027	000220	27	55,7	39,6	9,4	13,1	315	360	610778
W 20000028	000237	28	57,6	40,9	9,7	13,3	325	380	610796
W 20000029	000244	29	59,7	42,3	9,9	13,5	335	460	610796
W 20000030	000251	30	61,8	43,7	10,1	13,7	345	500	610779
W 20000032	000268	32	65,8	46,4	10,4	14,3	365	560	610780
W 20000033	000275	33	69,3	48,8	10,7	15,0	380	680	5
W 20000034	000282	34	69,2	48,8	10,7	15,0	380	680	5
W 20000035	000299	35	74,0	53,0	13,5	19,2	410	860	5 610781
W 20000036	000305	36	74,0	53,0	13,5	19,2	410	860	5 610782
W 20000038	000312	38	77,0	56,0	15,0	20,4	430	1000	5
W 20000041	000329	41	83,5	61,5	15,5	20,5	460	1260	5 610783
W 20000046	000336	46	91,5	66,5	16,2	21,0	500	1625	5 610786
W 20000050	000343	50	102,0	73,0	18,0	24,6	540	2120	5 610787
W 20000055	011639	55	118,0	86,0	21,0	28,0	560	2950	5 610789
W 20000060	011646	60	126,0	94,0	23,0	30,0	600	3750	5 610791
W 20000065	011653	65	148,0	108,0	23,0	32,0	680	5800	2
W 20000070	011660	70	148,0	108,0	23,0	32,0	680	5800	2



2090 METRIC COMBINATION WRENCH SET - 6 PCS.

- Supplied in nylon bag.

6
TOOLS



ITEM NO.	5704196+	QTY.	SIZE MM	G	IMPA CODE
20900006	000749	6	2000 10 - 12 - 13 - 14 - 17 - 19 mm	700	1 610532
P20900006	016955	1	Empty pouch for 2090-0006	106	1

2090 A METRIC COMBINATION WRENCH SET - 12 PCS.

- Supplied in nylon bag.

12
TOOLS



ITEM NO.	5704196+	QTY.	SIZE MM	G	IMPA CODE
20900012	009933	12	2000 8-9-10-11-12-13-14-15-16-17-18-19mm	1258	1 610533
P20900012	016962	1	Empty pouch for 2090-0012	164	1



POLAR® WRENCHES

2090 METRIC COMBINATION WRENCH SET - 26 PCS.

- Supplied in nylon bag.



ITEM NO.	5704196+	QTY.	SIZE MM	G	IMPA CODE
20900026	000756	26	20006-7-8-9-10-11-12-13-14-15-16-17-18-19-20-21-22-23-24-25-26-27-28-29-30-32mm	1742	1 610538
P20900026	016979	1	Empty pouch for 2090-0026	506	1

2090 B METRIC COMBINATION WRENCH SET - 12 PCS.

- Supplied in plastic holder.



ITEM NO.	5704196+	QTY.	SIZE MM	G	IMPA CODE
20900112	019529	12	8-9-10-11-12-13-14-15-16-17-18-19mm	1236	1

2000 INCH COMBINATION WRENCHES

ISO 3318, DIN 3113

- 12-Point ring angled at 15°. Open end angled at 15°.
- Surface: Satin chrome finish. Material: Chrome-vanadium steel.

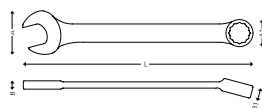

ITEM NO.	5704196+	SIZE "	A MM	A1 MM	B MM	B1 MM	L MM	G G	IMPA CODE
20001008	000350	1/4"	15,5	10,1	4,0	4,7	105	17	12 610801
20001010	000367	5/16"	19,2	12,8	4,5	5,5	125	26	12 610802
20001012	000374	3/8"	23,2	15,6	5,0	6,5	145	36	12 610803
20001014	000381	7/16"	25,3	16,9	5,4	6,9	155	44	12 610804
20001016	000398	1/2"	29,4	19,7	5,9	7,8	175	63	12 610805
20001018	000404	9/16"	31,5	21,2	6,2	8,3	185	78	12 610806
20001020	000411	5/8"	34,7	24,0	6,7	8,9	205	106	12 610807
20001022	000428	11/16"	36,5	25,3	6,9	9,3	215	132	12 610808
20001024	000435	3/4"	40,7	28,1	7,4	10,5	235	154	12 610809
20001026	000442	13/16"	44,8	31,3	8,0	11,3	255	200	12 610810
20001028	000459	7/8"	46,9	32,6	8,2	11,5	265	220	12 610811
20001030	000466	15/16"	50,4	35,5	8,7	12,1	285	280	6 610812
20001032	000473	1"	52,0	36,9	8,9	12,5	295	300	6 610813
20001034	000480	1 1/16"	55,7	39,6	9,4	13,1	315	360	6 610814
20001036	000497	1 1/8"	59,7	42,3	9,9	13,5	335	460	6 610815
20001040	000503	1 1/4"	65,8	46,4	10,4	14,3	365	560	6 610816

2090 INCH COMBINATION WRENCH SET - 12 PCS.

- Supplied in nylon bag.



ITEM NO.	5704196+	QTY.	SIZE "	G	IMPA CODE
20901012	000763	12	2000 1/4 - 5/16 - 3/8 - 7/16 - 1/2 - 9/16 - 5/8 - 11/16 - 3/4 - 13/16 - 7/8 - 1"	1569	1
P20901012	016986	1	Empty pouch for 2090-1012	245	1



2005 REVERSIBLE METRIC GEAR COMBINATION WRENCHES

ISO 1711-1, ISO 7738

- Reversible model with 72 teeth and a working angle of 5°.
- 12-Point ring angled at 15°. Open end angled at 15°.
- Surface: Satin chrome finish. Material: Chrome-vanadium steel.



ITEM NO.	5704196+	SIZE MM	A MM	A1 MM	B MM	B1 MM	L MM	G	IMPA CODE
w 20050008	013343	8	16,4	16,7	5,5	7,6	139	37	7 610831
w 20050009	013350	9	19,1	19,3	5,2	7,4	149	46	7 610832
w 20050010	013367	10	20,8	21,4	5,4	7,5	160	60	9 610833
w 20050011	013374	11	23,2	22,0	5,9	7,8	164	68	9 610834
w 20050012	013381	12	25,5	23,3	6,4	8,5	170	82	8 610835
w 20050013	013398	13	27,2	25,8	6,5	9,8	178	99	8 610836
w 20050014	013404	14	29,8	27,7	7,2	9,6	188	119	8 610837
w 20050015	013411	15	31,5	29,2	7,2	9,6	199	136	8 610838
20050016	013428	16	33,8	30,2	7,3	10,2	207	151	7
w 20050017	013435	17	35,3	33,2	8,3	10,2	223	186	8 610839
20050018	013442	18	33,4	33,9	8,6	10,8	234	220	8
w 20050019	013459	19	39,8	34,7	8,8	11,4	224	241	7 610840
20050020	013466	20	43,8	38,6	9,4	12,8	273	322	5
20050021	013473	21	43,6	37,6	9,5	12,5	274	313	5
w 20050022	013480	22	44,8	40,8	9,9	13,5	286	378	5
20050023	013497	23	44,3	40,5	9,5	13,7	285	364	5
w 20050024	013503	24	44,1	40,7	9,8	13,6	286	364	5
20050027	029559	27	55,5	49,0	10,0	16,0	355	658	5
20050030	029566	30	61,5	54,5	11,0	17,0	385	818	5
20050032	029573	32	67,0	58,0	11,0	17,0	415	948	5

2010 METRIC DOUBLE OPEN END WRENCHES

ISO 10102, DIN 3110.

- Open end angled at 15°.
- Surface: Satin chrome finish. Material: Chrome-vanadium steel.

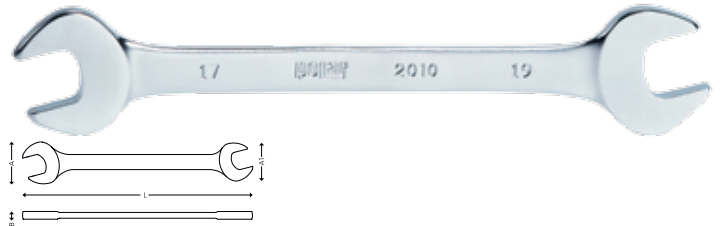

ITEM NO.	5704196+	SIZE MM	A MM	A1 MM	B MM	L MM	G	IMPA CODE
w 20100607	017921	6 x 7	15,5	18,0	3,7	123	19	12 610552
w 20100809	017938	8 x 9	20,4	22,7	4,5	140	34	12 610555
w 20101011	017945	10 x 11	24,9	27,1	5,7	156	61	12 610559
w 20101012	032610	10 x 12	24,9	27,1	4,8	156	60	12 610561
w 20101013	017952	10 x 13	24,9	31,2	5,5	172	74	12 610549
w 20101213	017969	12 x 13	29,2	31,3	5,5	172	72	12 610566
w 20101317	017983	13 x 17	31,3	38,9	6,5	195	109	12 610550
w 20101417	017976	14 x 15	33,3	35,3	7,6	190	107	12
w 20101415	032627	14 x 17	33,3	38,9	6,1	195	115	12 610568
20101617	017990	16 x 17	37,1	38,9	7,1	204	135	12
w 20101719	018003	17 x 19	40,9	42,8	7,1	221	156	12 610571
20101819	018010	18 x 19	40,9	42,8	7,2	221	158	12
20101922	018027	19 x 22	44,8	48,8	7,6	237	207	12 610573
w 20102022	018034	20 x 22	44,8	48,8	7,5	237	205	12 610575
w 20102123	018041	21 x 23	46,8	50,8	8,1	247	232	12
w 20102224	018058	22 x 24	46,8	50,8	8,7	247	249	12 610577
20102426	018065	24 x 26	50,8	56,8	8,3	255	286	10
20102427	018072	24 x 27	52,8	59,1	8,4	263	282	10
20102528	018089	25 x 28	54,8	61,3	9,2	279	381	5 610583
20102729	018096	27 x 29	56,8	62,3	8,7	283	382	5 610585
20103032	018102	30 x 32	65,4	69,8	9,8	298	460	6
20103236	018119	32 x 36	69,8	76,0	10,5	350	600	6 610588
20103436	018126	34 x 36	69,8	76,0	10,5	350	600	6 610589
20103641	018133	36 x 41	76,0	87,0	12,0	380	920	6 610591
20104146	018140	41 x 46	86,0	95,0	15,0	415	1300	5
20104650	018157	46 x 50	95,0	104,0	16,0	465	1900	5

2095 REVERSIBLE GEAR COMBINATION WRENCH SET - 12 PCS.

- Supplied in nylon bag.



ITEM NO.	5704196+	QTY.	SIZE MM	G	IMPA CODE
w 20950012	013206	12	2005 8-9-10-11-12-13-14-15-16-17-18-19 mm	1630	1 610501
P20950012	016993	1	Empty pouch for 2095-0012	195	1

2091 METRIC DOUBLE OPEN END WRENCH SET - 8 PCS.

- Supplied in nylon bag.



ITEM NO.	5704196+	QTY.	SIZE MM	G	IMPA CODE
w 20910008	018164	8	20106 x 7 - 8 x 9 - 10 x 11 - 12 x 13 - 14 x 15 - 16 x 17 - 18 x 19 - 20 x 22 mm	925	1 610501
P20910008	020464	1	Empty pouch for 2091-0008	135	1



POLAR® WRENCHES

2091 METRIC DOUBLE OPEN END WRENCH SET - 12 PCS.

- Supplied in nylon bag.



ITEM NO.	5704196+	QTY.	SIZE MM	G	IMP CODE
20910012	018171	12	2010 6x7-8x9-10x11x12x13-14x15-16x17-18x19-20x22-21x23-24x27-25x28-30x32 mm	2510	610504
P20910012	020013	1	Empty pouch for 2091-0012	270	1

2095 A/3 ADAPTOR SET FOR GEAR WRENCHES

- The set includes 3 adaptors for 1/4", 3/8" and 1/2" square.
- Socket retaining system with quick release button.
- Surface: Satin chrome finish. Material: Chrome-vanadium steel.



ITEM NO.	5704196+	QTY.	SIZE "/MM	G	IMP CODE
20950003	015651	3	1/4" / 10 mm - 3/8" / 13 mm - 1/2" / 19 mm	98	1

2070 DOUBLE SOCKET RATCHET WRENCHES

- Reversible model with 32 teeth and double 12-point metric socket.
- Surface: Phosphatised finish. Material: Chrome-vanadium steel.

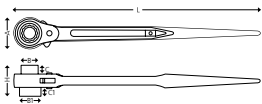

ITEM NO.	5704196+	SIZE MM	MAX. TORQUE NM	BXB1 MM	CXC1 MM	H MM	L MM	G	IMP CODE	
20701317	019130	13 x 17	137 - 157	18 x 23	8 x 8	44	280	285	2	611055
20701922	022932	19 x 22	510 - 589	26 x 29	16 x 16	50	315	460	2	611059
20701924	019147	19 x 24	510 - 589	26 x 32	16 x 16	55	315	785	2	611060
20702730	019154	27 x 30	1570 - 1669	37 x 40	18 x 18	63	450	1325	2	611068
20703236	019161	32 x 36	1570 - 1669	43 x 49	21 x 21	67	450	1325	2	



2100 METRIC COMBINATION WRENCHES OFFSET

- 12-Point ring angled at 70°. Open end angled at 15°.
- Surface: Chrome plated finish, with polished heads
- Material: Chrome-vanadium steel.

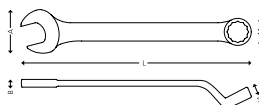

ITEM NO.	5704196+	SIZE MM	A MM	A1 MM	B MM	B1 MM	L MM	G	IMP CODE
21000006	005874	6	15,2	10,3	3,9	5,1	102	16	12
21000007	005881	7	17,3	11,5	4,1	6,3	112	20	12
21000008	005898	8	19,2	13,1	4,3	6,6	122	25	12
21000009	005904	9	21,1	14,0	4,8	7,3	131	33	12
21000010	005911	10	23,1	15,7	4,8	8,2	140	41	12
21000011	005928	11	25,0	17,0	5,3	8,4	150	50	12
21000012	005935	12	26,4	18,7	5,4	9,0	160	58	12
21000013	005942	13	29,2	21,1	5,5	9,5	170	74	6
21000014	005959	14	31,4	21,6	5,8	9,7	180	88	6
21000015	005966	15	33,1	22,9	6,2	9,7	190	103	6
21000016	005973	16	34,8	24,3	6,0	10,5	200	116	6
21000017	005980	17	36,3	25,2	6,5	11,5	210	135	6
21000018	005997	18	38,7	27,3	6,7	13,0	220	155	6
21000019	006000	19	40,4	28,3	7,2	13,4	230	184	6
21000021	006017	21	46,6	30,8	7,8	14,8	260	247	6
21000022	006024	22	46,6	30,8	7,8	14,8	260	247	6
21000024	006031	24	50,4	34,4	8,3	15,2	280	311	6
21000027	006048	27	55,3	38,4	8,5	16,2	310	390	6
21000030	006055	30	61,0	41,7	9,2	18,2	340	500	6
21000032	006062	32	65,5	44,5	10,1	19,5	360	621	6



2110 METRIC DOUBLE END OFFSET RING WRENCHES

ISO 10104, DIN 838.

- 12-Point ring angled at 70°.
- Surface: Satin chrome finish. Material: Chrome-vanadium steel.

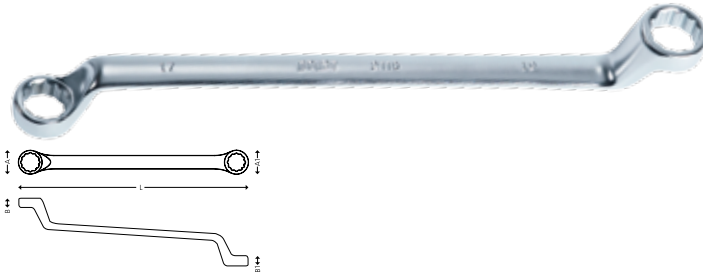

ITEM NO.	5704196+	SIZE MM	A MM	A1 MM	B MM	B1 MM	L MM	G G	IMPA CODE
21100607	018225	6 x 7	10,7	12,2	6,0	6,5	168	45	12 610726
21100809	018232	8 x 9	13,6	15,1	7,0	7,5	183	60	12 610727
W 21100810	018249	8 x 10	13,6	15,1	7,0	7,5	183	60	12 610728
W 21101011	018256	10 x 11	16,6	18,0	8,0	9,0	198	90	12 610729
21101012	032634	10 x 12	16,5	19,5	8,7	9,0	217	113	12 610724
W 21101213	018263	12 x 13	19,5	20,9	9,0	9,5	217	118	12 610725
21101415	018270	14 x 15	22,4	23,7	10,0	10,5	239	160	12
21101417	032641	14 x 17	22,0	26,0	9,2	10,5	195	115	6 610736
21101617	018287	16 x 17	25,3	26,7	11,0	11,3	260	185	6
21101719	018294	17 x 19	28,2	29,7	11,6	11,9	292	210	6 610739
21101819	018300	18 x 19	28,2	29,7	11,6	11,9	292	210	6
21101921	032658	19 x 21	29,0	33,7	11,5	12,5	296	300	6 610741
21101922	018317	19 x 22	31,1	34,0	12,2	12,9	318	320	6 610743
21102022	018324	20 x 22	31,1	34,0	12,2	12,9	318	320	6
21102123	018331	21 x 23	34,0	36,9	12,5	13,2	330	390	6 610745
W 21102224	018348	22 x 24	34,0	36,9	12,5	13,2	330	390	6
21102426	018355	24 x 26	36,9	41,4	13,5	14,4	345	500	6 610751
21102427	018362	24 x 27	36,9	41,4	13,5	14,4	345	500	6 610755
21102528	018379	25 x 28	40,4	43,8	13,8	14,7	355	520	6
W 21103032	018386	30 x 32	45,5	48,5	15,4	16,0	370	670	5
21103641	018393	36 x 41	53,5	62,0	18,0	20,0	451	1130	4
21104650	018409	46 x 50	70,0	76,0	21,0	23,5	526	1820	2



2195 METRIC DOUBLE END OFFSET RING WRENCH SET - 8 PCS.

- Supplied in nylon bag.



8
TOOLS

ITEM NO.	5704196+	QTY.	SIZE MM	G	IMPA CODE
21950008	018416	8	2110 6 x 7 - 8 x 9 - 10 x 11 - 12 x 13 - 14 x 15 - 16 x 17 - 18 x 19 - 20 x 22 mm	1410	1
P21950008	027098	1	Empty pouch for 2195-0008	183	1

2195 METRIC DOUBLE END OFFSET RING WRENCH SET - 12 PCS.

- Supplied in nylon bag.



12
TOOLS

ITEM NO.	5704196+	QTY.	SIZE MM	G	IMPA CODE
21950012	018423	12	2110 6x7-8x9-10x11-12x13-14x15-16x17-18x19-20x22-21x23-24x27-25x28-30x32 mm	3650	1 610521
P21950012	020020	1	Empty pouch for 2195-0012	343	1



POLAR® WRENCHES

2200 METRIC FLARE NUT WRENCHES

DIN 3118.

- Open ring angled at 15°. Head angled at 15°.
- Hexagonal profile up to size 12x14 mm and bihexagonal profile for larger sizes.
- Surface: Satin chrome finish. Material: Chrome-vanadium steel.

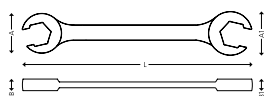

ITEM NO.	5704196+	SIZE MM	A MM	A1 MM	B MM	B1 MM	L MM	G	
22000810	017242	8 x 10	18,4	20,8	7,0	8,5	145	47	12
22000911	017259	9 x 11	20,8	22,6	8,5	9,0	152	60	12
22001113	017266	11 x 13	22,6	25,0	9,0	10,5	165	78	12
22001214	017273	12 x 14	25,0	27,4	9,5	11,0	178	120	6
22001719	017280	17 x 19	30,0	32,5	12,0	14,0	210	180	6
22001922	017297	19 x 22	32,5	38,0	14,0	16,0	233	240	6
22002224	017303	22 x 24	38,0	41,0	16,0	17,0	252	300	6
22002427	017310	24 x 27	41,0	45,0	17,0	18,0	265	350	6
22003032	017327	30 x 32	48,5	51,0	21,0	23,0	285	470	6
22003641	017334	36 x 41	58,0	65,0	25,0	27,0	350	820	6

2400 METRIC DOUBLE SWIVEL END SOCKET WRENCHES

ISO 1711-1, DIN 899

- Double ended wrenches with 12-Point sockets. Spring washer inside the joints.
- Surface: Chrome plated finish with polished heads. Material: Chrome-vanadium steel.

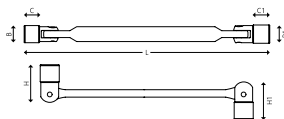
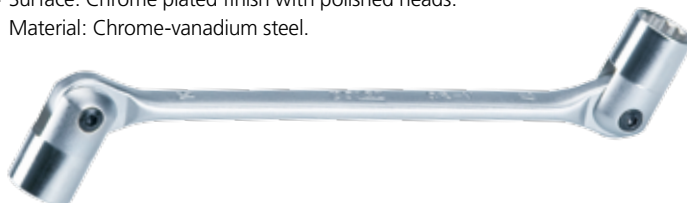

ITEM NO.	5704196+	SIZE MM	BXB1 MM	CXC1 MM	HXH1 MM	L MM	G	
24000809	006222	8 x 9	12,9 x 13,7	7,5 x 7,5	16,0 x 16,8	180	80	5
24001011	006239	10 x 11	14,7 x 15,8	10,0 x 10,0	18,8 x 19,2	199	106	5
24001213	006246	12 x 13	17,6 x 18,7	13,2 x 11,4	23,0 x 22,5	219	163	5
24001415	006253	14 x 15	19,6 x 21,6	13,9 x 14,3	24,0 x 25,4	240	231	5
24001617	006260	16 x 17	23,7 x 23,7	13,7 x 14,3	29,2 x 29,2	264	333	5
24001819	006277	18 x 19	25,7 x 25,7	15,9 x 15,2	29,2 x 29,2	274	400	5
24002022	006284	20 x 22	29,7 x 32,8	21,8 x 20,8	35,6 x 40,5	303	516	5
24002123	006291	21 x 23	29,7 x 33,9	22,1 x 21,1	35,4 x 39,9	303	555	12

2290 METRIC FLARE NUT WRENCH SET

- Supplied in nylon bag.



ITEM NO.	5704196+	QTY.	SIZE MM	G	
22900007	017341	7	2200 8x10-9x11-11x13-12x14-17x19-19x22-24x27mm	1240	1
P22900007	020457	1	Empty pouch for 2290-0007		1

2490 DOUBLE SWIVEL END SOCKET WRENCH SET

- Supplied in nylon bag.



ITEM NO.	5704196+	QTY.	SIZE MM	G	
24900006	000794	6	2400 8x9-10x11-12x13-14x15-16x17-18x19 mm	1409	1
P24900006	017006	1	Empty pouch for 2490-0006	112	1

2405 METRIC SWIVEL GEAR COMBINATION WRENCHES

ISO 1711-1.

- 180° swivel head with 72 teeth and a working angle of 5°.
- Open end angled at 15°.
- Surface: Satin chrome finish. Material: Chrome-vanadium steel.

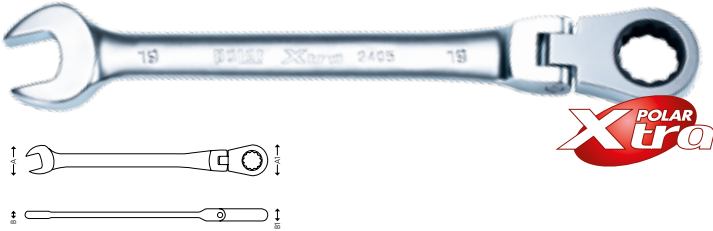

ITEM NO.	5704196+	SIZE MM	A MM	A1 MM	B MM	B1 MM	L MM	G G		
24050008	013220	8	17,2	17,2	5,3	7,3	142	47		10
24050009	013237	9	19,1	20,4	5,1	7,3	153	57		13
24050010	013244	10	21,2	21,0	6,0	7,6	161	73		10
24050011	013251	11	23,3	22,6	6,5	7,9	167	85		10
24050012	013268	12	25,6	23,4	6,5	8,5	172	100		10
24050013	013275	13	26,8	25,7	7,3	9,6	182	124		11
24050014	013282	14	29,8	27,7	7,6	9,5	193	141		11
24050015	013299	15	30,7	30,0	7,3	9,9	201	151		9
24050016	013305	16	33,7	30,2	7,6	10,4	212	179		9
24050017	013312	17	35,8	32,7	8,7	10,2	225	211		10
24050018	013329	18	37,7	32,3	8,7	10,8	233	242		7
24050019	013336	19	39,5	35,2	9,1	11,5	247	272		7

2495 SWIVEL GEAR COMBINATION WRENCH SET

- Supplied in nylon bag.



ITEM NO.	5704196+	QTY.	SIZE MM	G G	
24950012	013213	12	24058-9-10-11-12-13-14-15-16-17-18-19mm	1840	1
P24950012	017020	1	Empty pouch for 2495-0012	189	1





POLAR® WRENCHES

ADJUSTABLE WRENCHES

2600 ADJUSTABLE WRENCHES

ISO 6787, DIN 3117

- Grinded head tip and 15° angel. Scale in mm. Left knurling.
 - Surface: Phosphatised finish with polished head.
- Material: Chrome-vanadium steel.

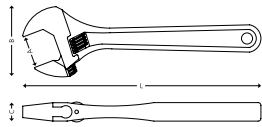

ITEM NO.	5704196+	L MM	L' MM	A MM	B MM	C MM	G	IMPA CODE
26000004	006307	110	4"	17	35,4	4,6	58	10 611331
26000006	006314	150	6"	23	50,3	6,2	120	10 611332
26000008	006321	200	8"	28	63,3	6,9	240	5 611333
26000010	006338	250	10"	32	73,8	8,1	400	5 611334
26000012	006345	300	12"	38	83,6	9,4	650	5 611335
26000015	006352	375	15"	51	109	10,5	1225	4 611336
26000018	006369	450	18"	61	128,2	10,0	1740	5 611337
26000024	006376	600	24"	70	148	12,4	3700	1 611338

2602 ADJUSTABLE WRENCHES - EXTRA WIDE OPENING

ISO 6787, DIN 3117

- Grinded head tip and 15° angel. Scale in mm.
 - Ergonomic rubbercoated handle. Left knurling.
 - Surface: Phosphatised finish with polished head.
- Material: Chrome-vanadium steel.

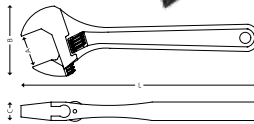

ITEM NO.	5704196+	L MM	L' MM	A MM	B MM	C MM	G	IMPA CODE
26020006	018812	150	6"	35	65	3	125	10
26020008	018829	200	8"	40	70	4,6	255	5
26020010	018836	250	10"	50	90	6	505	5

2690 ADJUSTABLE WRENCH SET

- Supplied in nylon bag.



ITEM NO.	5704196+	QTY.	SIZE MM"	G	IMPA CODE
26900003	018577	3	2600 150 mm / 6" - 200 mm / 8" - 250 mm / 10"	900	1
P26900003	017105	1	Empty pouch for 2690-0003	102	1

2610 GATOR ADJUSTABLE WRENCH

ISO 6787, DIN 3117

- "Alligator"-jaw for use on pipes and rounded fasteners giving a sure grip.
 - Grinded head tip and 15° angel.
 - Scale in mm. Left knurling.
 - Surface: Phosphatised finish with polished head.
- Material: Chrome-vanadium steel.

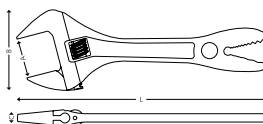

ITEM NO.	5704196+	L MM	L' MM	A MM	B MM	C MM	G	IMPA CODE
26100008	026381	200	8	32	65	5,5	232	1



TORQUE WRENCHES

POLAR® offers a large selection of digital and click-type torque wrenches, to help you get the job done right the first time. Our range of digital torque tools, with easy-to-use push buttons, precisely measures torque applied to fasteners.

- Click-type torque wrenches
- Digital torque wrenches
- Digital torque wrenches with angle measurements
- Digital torque bit drivers
- Digital torque screwdrivers
- Digital torque and angle adapters
- Digital angle meter with magnet



• Durable 52-teeth ratchet

• ± 2% accuracy

• Acoustic and LED signals

• Large easy-to-read display

POLAR® TORQUE WRENCHES

7100 TORQUE WRENCHES

ISO 6789, DIN 3122, EN 26789

- Adjustable torque wrench with reversible ratchet.
- Angle indication printed on ratchet head for tightenings with angle control.
- Precision: $\pm 4\%$.
- Click-signal on reaching preset torque value.
- Supplied with calibration certificate.
- Wrench is supplied in protective plastic case.



ITEM NO.	5704196+	CAPACITY NM	INCREMENTS NM	■	L MM	KG	IMPA CODE
71140020	018720	4-20	0,1	1/4"	325	650	1 611427
71380060	018737	10-60	0,5	3/8"	335	750	1 611429
71380120	018744	20-120	1	3/8"	445	1250	1
71120200	018751	40-200	1	1/2"	510	1550	1 611431
71120340	018768	60-340	2	1/2"	615	1750	1
71340600	018775	100-600	5	3/4"	1050	4950	1 611442
71341000	018782	200-1000	5	3/4"	1240	6000	1

7200 INDUSTRIAL TORQUE WRENCHES

- Reversible ratchet, 72 teeth.



ITEM NO.	5704196+	CAPACITY NM	■	L MM	KG
72120060	027821	10-60	1/2"	380	1,0
72120100	027838	20-100	1/2"	450	1,2
72120200	027845	40-200	1/2"	450	1,2
72120350	027852	60-350	1/2"	590	1,45
72340800	027869	160-800	3/4"	1140	6,7
72341000	027876	200-1000	3/4"	1340	7,4

7200I INDUSTRIAL TORQUE WRENCHES WITH INTERCHANGEABLE HEADS

- Large program in various inserts.



ITEM NO.	5704196+	INSERT SIZE (WxH MM)	CAPACITY NM	L MM	KG
72123060	029993	9 x 12 mm	10-60	380	1,0
72123100	030005	9 x 12 mm	20-100	445	1,1
72123200	030012	14 x 18 mm	40-200	450	1,1
72123350	030029	14 x 18 mm	60-350	580	1,4

INDUSTRIAL TORQUE WRENCHES



Reversible ratchet,
72 teeth. (only 7200)

The measuring element
is only under load
while force is being
applied, resulting in
long life accuracy and
repeatability.

Accuracy: $\pm 3\%$ in
accordance with
EN ISO 6789:2003

No need to turn back
to the minimum scale
value after being
used.

Quick and precise
slide adjustment by
unscrewing the knob
and pushing the slider
on the scale to the
required value.

Ergonomic handle.

POLAR® TORQUE WRENCHES



ALUMINIUM TORQUE WRENCHES



Chrome-plating finish strengthens the material hardness and anti-collision.

Designed for industrial work, for example aerospace-, windpower- and automation industries.



Square driver: Chrome-molybdenum alloy steel brings better strength, toughness, stability and life cycle.

The weight of aluminium is extremely lighter than steel. Good for long time operation and heavy industry.

Integrated 3-lever chain mechanism brings length independence, greater sensitivity, high accuracy and a long life cycle.

Loud click sound and strong impulse when reaching required torque.

Dual scales of torque measurement (Nm og ft-lb).

Engraved serial no. for tracing.

Nice-to-hold handgrip enables safe work and less operator fatigue.

Fast and easy torque adjustment with unique "Quick pull out" crank.

7200 ALUMINIUM TORQUE WRENCHES



ITEM NO.	5704196+	CAPACITY NM	INCREMENTS NM	L MM	KG		
72121200	028194	40-200	5	1/2"	563	1,5	1
72341550	028200	110-550	10	3/4"	827	3,0	1
72341760	028217	140-760	10	3/4"	827	3,0	1
72341001	028224	200-1000	10	3/4"	1413	3,8	1
72011500	028231	600-1500	25	1"	1615	10,9	1
72012000	028248	750-2000	50	1"	2370	11,7	1



POLAR® TORQUE WRENCHES



7300 A DIGITAL TORQUE WRENCHES

ISO 6789, DIN 3122, EN 26789

- Digital torque wrench with reversible 36 teeth ratchet, for both clockwise and counterclockwise operation.
- Accuracy: ± 2% (CW) / ± 3% (CCW) from 20% to 100% of full scale
- Two operation modes: Track (shows actual torque applied) and Peak (shows maximum reached torque).
- 4 Torque units: Nm, kg-cm, in-lb and ft-lb.
- Acoustic and green/red LED signal at preset torque value.
- Memory function with 9 preset torque values and 50 measurements.
- Battery life (continuous operation): 110 hrs.
- Operating temperature: -10°C ~ 60°C.
- Storage temperature: -20°C ~ 70°C.
- Comfortable, non-slip grip handle.
- Humidity: Up to 90% non-condensing.
- Supplied with test certificate, batteries and storage case.



ITEM NO.	5704196+	CAPACITY NM	INCREMENTS NM	■	L MM	G	■	IMPA CODE
73141030	022055	1,5-30	0,01	1/4"	390	727	1	611417
73381135	022062	6,8-135	0,1	3/8"	415	898	1	611419
73121200	022078	10-200	0,1	1/2"	530	1333	1	611420
73121340	022086	17-340	0,1	1/2"	650	1508	1	611421

7300 B DIGITAL TORQUE WRENCHES WITH INTERCHANGEABLE HEADS

ISO 6789, DIN 3122, EN 26789

- Digital torque wrench with reversible 52 teeth ratchet, for both clockwise and counterclockwise operation.
- Accuracy: ± 2% (CW) / ± 3% (CCW) from 20% to 100% of full scale.
- Two operation modes: Track (shows actual torque applied) and Peak (shows maximum reached torque).
- 4 Torque units: Nm, kg-cm, in-lb and ft-lb.
- Acoustic and green/red LED signal at preset torque value.
- Memory function with 9 preset torque values and 50 measurements.
- Battery life (continuous operation): 110 hrs.
- Operating temperature: -10°C ~ 60°C.
- Storage temperature: -20°C ~ 70°C.
- Comfortable, non-slip grip handle.
- Humidity: Up to 90% non-condensing.
- Supplied with test certificate, batteries and storage case.
- Large program in various inserts.



ITEM NO.	5704196+	CAPACITY NM	INCREMENTS NM	INSERT SIZE (WxH MM)	■	L MM	G	■
73142030	022215	1,5-30	0,01	12 x 9	1/4"	388	768	1
73382135	022222	6,8-135	0,1	12 x 9	3/8"	408	936	1
73122200	022239	10-200	0,1	18 x 14	1/2"	518	1385	1
73122340	022246	17-340	0,1	18 x 14	1/2"	638	1555	1



POLAR® TORQUE WRENCHES



7400 DIGITAL TORQUE WRENCHES WITH ANGLE MEASUREMENT

ISO 6789, DIN 3122, EN 26789

- Digital torque wrench with reversible 36 teeth ratchet, for both clockwise and counterclockwise operation.
- Perform torque and angle thightnings in a single-step operation.
- Accuracy: $\pm 2\%$ (CW) / $\pm 3\%$ (CCW) from 20% to 100% of full scale and $\pm 2\%$ for 90° rotation.
- Operation modes: Track (shows actual torque applied), Peak (shows maximum reached torque) and Angle.
- 5 measuring units: Nm, kg-cm, in-lb, ft-lb and angle.
- Acoustic and green/red LED signal at preset torque value.
- Memory function with 9 preset torque values and 50 measurements.
- Battery life (continuous operation): 110 hrs.
- Operating temperature: -10°C ~ 60°C.
- Storage temperature: -20°C ~ 70°C.
- Comfortable, non-slip grip handle.
- Humidity: Up to 90% non-condensing.
- Supplied with test certificate, batteries and storage case.



ITEM NO.	5704196+	CAPACITY NM	INCREMENTS NM	■	L MM	G	
74140030	022017	1,5-30	0,01	1/4"	390	729	1
74380135	022024	6,8-135	0,1	3/8"	415	901	1
74120200	022031	10-200	0,1	1/2"	530	1338	1
74120340	022048	17-340	0,1	1/2"	650	1509	1

7614 1/4" DIGITAL MINI TORQUE WRENCH

ISO 6789, EN 26789

- Digital torque wrench with 60 teeth reversible ratchet bit holder, for both clockwise and counterclockwise operation.
- Drivers accept all standard 1/4" hex screwdriver bits.
- Accuracy: $\pm 3\%$ (CW) / $\pm 4\%$ (CCW) from 20% to 100% of full scale.
- Two operation modes: Track (shows actual torque applied) and Peak (shows maximum reached torque).
- 4 Torque units: Nm, kg-cm, in-lb and ft-lb.
- Acoustic and green/red LED signal at preset torque value.
- Battery life (continuous operation): 55 hrs.
- Operating temperature: -10°C ~ 60°C.
- Storage temperature: -20°C ~ 70°C.
- Comfortable, non-slip grip handle.
- Humidity: Up to 90% non-condensing.
- Supplied with test certificate, batteries and storage case.



ITEM NO.	5704196+	CAPACITY NM	INCREMENTS NM	INSERT SIZE (WXHMM)	L MM	G	
76140020	022123	1-20	0,01	1/4"	207	167	1

7638 3/8" DIGITAL MINI TORQUE WRENCH

ISO 6789, DIN 3122, EN 26789

- Digital torque wrench with reversible 60 teeth ratchet, for both clockwise and counterclockwise operation.
- Accuracy: $\pm 3\%$ (CW) / $\pm 4\%$ (CCW) from 20% to 100% of full scale.
- Two operation modes: Track (shows actual torque applied) and Peak (shows maximum reached torque).
- 4 Torque units: Nm, kg-cm, in-lb and ft-lb.
- Acoustic and green/red LED signal at preset torque value.
- Battery life (continuous operation): 55 hrs.
- Operating temperature: -10°C ~ 60°C.
- Storage temperature: -20°C ~ 70°C.
- Comfortable, non-slip grip handle.
- Humidity: Up to 90% non-condensing.
- Supplied with test certificate, batteries and storage case.



ITEM NO.	5704196+	CAPACITY NM	INCREMENTS NM	■	L MM	G	
76380085	022147	4,3-85	0,01	3/8"	239	387	1



POLAR® TORQUE WRENCHES



7690 1/4" BICYCLE TOOL KIT

ITEM NO. 76901409

- Avoid overload when working on bicycle frames.
- Ideal for every bike enthusiast as well as professionals.
- Tool set supplied in plastic storage case with digital torque wrench and bits.
- *Technical information refer to item no. 7614.*

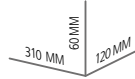

618 G

5704196 022130

1

CONTENT:

QTY.	DESCRIPTION	SIZE
1	Digital torque wrench	7614 1-20 Nm - 1/4" bit driver
6	Bits for hex head screws	4514 1/4" H 2 - 2,5 - 3 - 4 - 5 - 6 mm
1	Bits for Torx® head screws	4514 1/4" TX T25
1	Bits for Phillips® screws	4514 1/4" PH2



7690 3/8" BICYCLE TOOL KIT

ITEM NO. 76903820

- Avoid overload when working on bicycle frames.
- Ideal for every bike enthusiast as well as professionals.
- Tool set supplied in plastic storage case with digital torque wrench and bits.
- *Technical information refer to item no. 7638.*

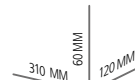

1133 G

5704196 022154

1

CONTENT:

QTY.	DESCRIPTION	SIZE
1	Digital Torque Wrench	7638 4,3-85 Nm - 3/8" Square
1	Screwdriver bit socket	4738 3/8"
8	6-point sockets	5038 3/8" 8 - 9 - 10 - 11 - 12 - 13 - 14 - 15 mm
6	Bits for hex head screws	4514 1/4" H 3 - 4 - 5 - 6 - 8 - 10 mm
3	Bits for Torx® head screws	4514 1/4" TX T25 - T30 - T40
1	Bits for Phillips® screws	4514 1/4" PH 2





POLAR® TORQUE WRENCHES



7514 A DIGITAL SCREWDRIVER

ISO 6789, EN 26789

- Digital torque screwdriver with quick-release bit holder, for both clockwise and counterclockwise operation.
- Drivers accept all standard 1/4" hex screwdriver bits.
- Accuracy: $\pm 3\%$ (CW) / $\pm 4\%$ (CCW) from 20% to 100% of full scale.
- Two operation modes: Track (shows actual torque applied) and Peak (shows maximum reached torque).
- 3 Torque units: cNm, kg-cm and in-lb.
- Acoustic and green/red LED signal at preset torque value.
- Memory function with 9 preset torque values and 50 measurements.
- Battery life (continuous operation): 12 hrs.
- Operating temperature: -10°C ~ 60°C.
- Storage temperature: -20°C ~ 70°C.
- Comfortable, non-slip grip handle.
- Humidity: Up to 90% non-condensing.
- Supplied with test certificate, batteries and storage case.



ITEM NO.	5704196+	CAPACITY C NM	INCREMENTS NM	Ø	L MM	G	📦
75140050	022093	5,0-50	0,1	1/4"	193	142	1

7514 B/C DIGITAL SCREWDRIVERS

ISO 6789, EN 26789

- Digital torque screwdriver with quick-release bit holder, for both clockwise and counterclockwise operation.
- Drivers accept all standard 1/4" hex screwdriver bits.
- Accuracy: $\pm 2.5\%$ (CW) / $\pm 3.5\%$ (CCW) from 20% to 100% of full scale.
- Two operation modes: Track (shows actual torque applied) and Peak (shows maximum reached torque).
- 3 Torque units: cNm, kg-cm and in-lb.
- Acoustic and green/red LED signal at preset torque value.
- Memory function with 9 preset torque values and 50 measurements.
- Battery life (continuous operation): 55 hrs.
- Operating temperature: -10°C ~ 60°C.
- Storage temperature: -20°C ~ 70°C.
- Comfortable, non-slip grip handle.
- Humidity: Up to 90% non-condensing.
- Supplied with test certificate, batteries and storage case.



ITEM NO.	5704196+	CAPACITY C NM	INCREMENTS NM	Ø	L MM	G	📦
75140200	022109	10-200	0,1	1/4"	203	179	1
75140400	022116	20-400	0,1	1/4"	203	179	1

7700 DIGITAL TORQUE AND ANGLE ADAPTERS

ISO-6789

- Digital torque and angle adapter, for both clockwise and counterclockwise operation.
- Perform torque and angle tightenings in a single-step operation, using any tightening tool.
- The adapter can be used for verifying any mechanical torque wrench accuracy.
- Accuracy: $\pm 3\%$ from 20% to 100% of full scale and $\pm 2\%$ for 90° rotation.
- Operation modes: Track (shows actual torque applied), Peak (shows maximum reached torque) and Angle.
- 5 measuring units: Nm, kg-cm, in-lb, ft-lb and angle.
- Acoustic and green/red LED signal at preset torque value.
- Memory function with 9 preset torque values and 50 measurements.
- Battery life (continuous operation): 110 hrs.
- Operating temperature: -10°C ~ 60°C. Storage temperature: -20°C ~ 70°C.
- Humidity: Up to 90% non-condensing.
- Supplied with test certificate, batteries and storage case.



ITEM NO.	5704196+	CAPACITY NM	INCREMENTS NM	Ø	SIZE MM	G	📦
77140030	022178	1,5-30	0,01	1/4"	86 x 85 x 60	163	1
77380135	022185	6,8-135	0,1	3/8"	85 x 85 x 75	216	1
77120200	022192	10-200	0,1	1/2"	85 x 85 x 80	240	1
77120340	022208	17-340	0,1	1/2"	85 x 85 x 80	240	1



POLAR® TORQUE WRENCHES



7700 A DIGITAL ANGLE METER WITH MAGNET

- Digital angle meter for both clockwise and counter-clockwise operation.
- Built-in magnet for easily fastening to any tightening tool.
- Accuracy: $\pm 2\%$ for 90° rotation.
- Acoustic and green/red LED signal at preset angle value.
- Memory function with 9 preset angle values and 50 measurements.
- Battery life (continuous operation): 24 hrs.
- Operating temperature: -10°C ~ 60°C.
- Storage temperature: -20°C ~ 70°C.
- Humidity: Up to 90% non-condensing.
- Supplied with test certificate, batteries and storage case.



ITEM NO.	5704196+	SCALE	INCREMENTS	RESOLUTION	DISPLAY RANGE	SIZE MM	G	
77000001	022161	1-360°	1°	0,1°	1-999°	58x58x41	72	1

7801 BOX END METRIC INSERTS

- 9 x 12 mm
- Surface: Chrome plated finish.
- Material: Chrome-vanadium steel

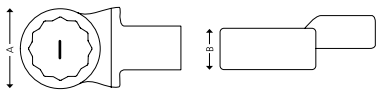

ITEM NO.	5704196+	SIZE mm	A MM	B MM	G	
78010007	022413	7	20	8	39	1
78010008	022420	8	20	8	39	1
78010010	022437	10	20	8	41	1
78010011	022444	11	20	8	43	1
78010012	022451	12	22	12	53	1
78010013	022468	13	22	12	51	1
78010014	022475	14	24	12	55	1
78010015	022482	15	25	13	56	1
78010016	022499	16	27	13	58	1
78010017	022505	17	28	13	60	1
78010018	022512	18	29	13	61	1
78010019	022529	19	31	13	65	1
78010021	022536	21	34	15	71	1
78010022	022543	22	35	15	72	1

7803 BOX END METRIC INSERTS

- 14 x 18 mm
- Surface: Chrome plated finish.
- Material: Chrome-vanadium steel

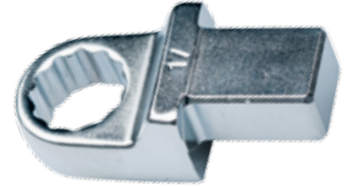
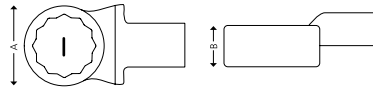

ITEM NO.	5704196+	SIZE MM	A MM	B MM	G	
78030013	022727	13	30	12	129	1
78030014	022734	14	30	12	129	1
78030015	022741	15	30	12	129	1
78030016	022758	16	31	12	130	1
78030017	022765	17	31	13	134	1
78030018	022772	18	31	13	139	1
78030019	022789	19	31	12	140	1
78030021	022796	21	33	15	152	1
78030022	022802	22	35	15	156	1
78030024	022819	24	38	15	156	1
78030027	022826	27	41	18	200	1
78030030	022833	30	45	18	204	1
78030032	022840	32	48	18	202	1
78030034	022857	34	51	19	223	1
78030036	022864	36	53	19	218	1
78030041	022871	41	60	19	228	1

7800 OPEN END METRIC INSERTS

- 9 x 12 mm
- Surface: Chrome plated finish.
- Material: Chrome-vanadium steel

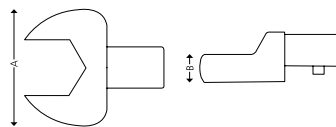

ITEM NO.	5704196+	SIZE MM	A MM	B MM	G	
78000007	022284	7	21	6	39	1
78000008	022291	8	22	6	39	1
78000009	022307	9	23	6	39	1
78000010	022314	10	25	6	41	1
78000011	022321	11	26	6	43	1
78000012	022338	12	28	6	39	1
78000013	022345	13	29	6	44	1
78000014	022352	14	31	8	54	1
78000015	022369	15	33	8	58	1
78000016	022376	16	36	8	61	1
78000017	022383	17	38	8	59	1
78000018	022390	18	39	8	64	1
78000019	022406	19	42	8	64	1

7802 OPEN END METRIC INSERTS

- 14 x 18 mm
- Surface: Chrome plated finish.
- Material: Chrome-vanadium steel

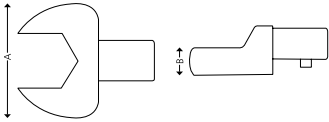

ITEM NO.	5704196+	SIZE MM	A MM	B MM	G	
78020013	022550	13	30	7	116	1
78020014	022567	14	32	7	119	1
78020015	022574	15	34	7	116	1
78020016	022581	16	36	7	127	1
78020017	022598	17	37	9	139	1
78020018	022604	18	39	9	137	1
78020019	022611	19	41	9	139	1
78020021	022628	21	45	12	158	1
78020022	022635	22	47	12	163	1
78020024	022642	24	51	12	170	1
78020027	022659	27	59	14	233	1
78020030	022666	30	63	14	245	1
78020032	022673	32	65	14	245	1
78020034	022680	34	66	14	246	1
78020036	022697	36	67	14	239	1
78020038	022703	38	66	14	224	1
78020041	022710	41	82	14	319	1

7800 R RATCHET INSERTS

- Reversible model with 52 teeth.
- Surface: Chrome plated finish.
- Material: Chrome-vanadium steel

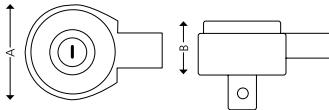

ITEM NO.	5704196+	INSERT SIZE (W X H MM)	MAX. TORQUE Nm	A MM	B MM	G	
78140912	022253	1/4" 12x9	30	25	17	69	1
78380912	022260	3/8" 12x9	135	35	23	143	1
78121418	022277	1/2" 18x14	340	43	29	316	1

The inserts are suitable for torque wrenches model 7300 B and 7200 I.





POLAR® PLIERS

PLIERS

POLAR® pliers give you control and comfort. The quality forged steel ensures strength and durability.

The handles are designed to offer increased leverage and power.

- Pliers
- Insulated pliers
- Pipe wrenches
- Circlip pliers
- Locking pliers
- Scissors
- Files





PLIERS

3001 COMBINATION PLIER

ISO 5746, DIN 5746

- Model with cutter for piano wire (200 kg/mm²) and knurled gripping surface.
 - Ergonomic handles with wide palm support.
 - Surface: Phosphatised finish with polished head.
- Material: Chrome-molybdenum steel.

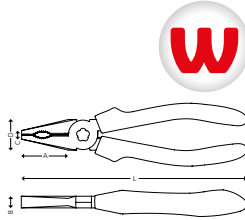

ITEM NO.	5704196+	L	Ø MAX.	A	B	C	D	G	IMPA CODE
		MM	MM	MM	MM	MM	MM		
1010680	007601	180	1,8	38,0	10,0	6,0	26,5	231	6 611658

3005 HALF-ROUND LONG NOSE PLIERS WITH STRAIGHT JAWS

ISO 5745, DIN 5745

- Model with cutter for hard wire (160 kg/mm²) and knurled gripping surface.
 - Ergonomic handles with wide palm support.
 - Surface: Phosphatised finish with polished head.
- Material: Chrome-molybdenum steel.

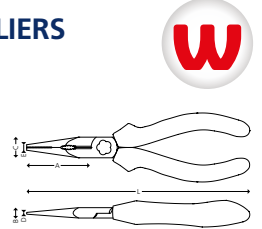

ITEM NO.	5704196+	L	Ø MAX.	D X E	A	B	C	G	IMPA CODE
		MM	MM	MM	MM	MM	MM		
1010683	007731	160	1,6	2,0 x 3,0	48,0	8,0	18,3	144	6 611695
1010684	007748	200	2,0	3,0 x 4,0	70,0	10,7	21,4	238	6 611696

3002 DIAGONAL CUTTERS

ISO 5749, DIN 5749

- Model with cutter for hard wire (160 kg/mm²).
 - Ergonomic handles with wide palm support.
 - Surface: Phosphatised finish with polished head.
- Material: Chrome-molybdenum steel.

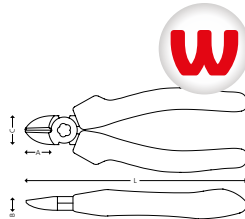

ITEM NO.	5704196+	L	Ø MAX.	A	B	C	G	IMPA CODE
		MM	MM	MM	MM	MM		
30020125	007625	125	1,4	20,0	9,5	18,6	126	6 611711
1010681	007656	160	1,6	20,0	10,0	19,6	188	6 611712

3006 HALF-ROUND NOSE PLIERS WITH BENT JAWS

- Model with cutter for hard wire (160 kg/mm²) and knurled gripping surface.
 - Ergonomic handles with wide palm support.
 - Surface: Phosphatised finish with polished head.
- Material: Chrome-molybdenum steel.

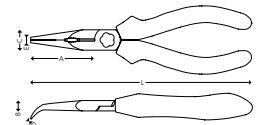

ITEM NO.	5704196+	L	Ø MAX.	D X E	A	B	C	G	IMPA CODE
		MM	MM	MM	MM	MM	MM		
1010685	007755	160	1,6	2,0 x 3,5	45,0	9,0	18,0	142	6 611691
30060200	007762	200	2,0	2,5 x 4,0	65,0	10,5	21,5	234	6

3004 HEAVY-DUTY DIAGONAL CUTTERS

ISO 5749, DIN 5749

- Model with cutter for piano wire (200 kg/mm²).
 - Ergonomic handles with wide palm support.
 - Surface: Phosphatised finish with polished head.
- Material: Chrome-molybdenum steel.

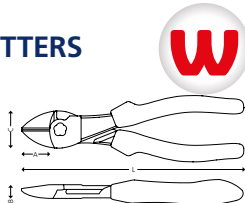

ITEM NO.	5704196+	L	Ø MAX.	A	B	C	G	IMPA CODE
		MM	MM	MM	MM	MM		
30040180	015460	180	1,8	21,0	11,1	28,6	244	6 611717
1010682	015590	200	2,0	21,0	12,2	29,7	293	6 911718

3009 WIRE STRIPPER

- Model with opening spring and adjusting screw.
 - Ergonomic handles with wide palm support.
 - Surface: Phosphatised finish with polished head.
- Material: Chrome-molybdenum steel.

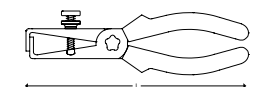

ITEM NO.	5704196+	MAX. MM ²	L	G	IMPA CODE
			MM		
30090160	007793	6	160	142	6 611741



POLAR® PLIERS

3020 BOX-JOINT WATER PUMP PLIER

ISO 8976, DIN 8976

- Model with 7 positions and knurled gripping surface.
 - Ergonomic handles with wide palm support.
 - Surface: Phosphatised finish with polished head.
- Material: Chrome-molybdenum steel.

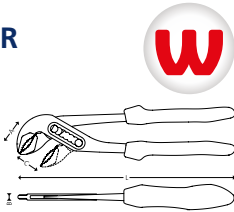

ITEM NO.	5704196+	L MM	A MM	B MM	C MM	G G	IMPA CODE
1010686	007922	250	35,0	8,0	34,0	354	6 611622

3025 TONGUE AND GROOVE PLIER

- Right angle.
- Laser heat-treated teeth grip better and last longer.
- Patented reinforcing edge.
- Permalock® fastener eliminates nut and bolt failure.
- High carbon steel for superior performance and an ultimate rust preventative coating.
- Comfort grips.

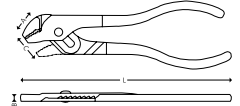

ITEM NO.	5704196+	L MM	A MM	B MM	C MM	G G	IMPA CODE
30250115	028507	115	8	3	13	38	5

3024 TONGUE AND GROOVE PLIERS

- Right angle.
- Laser heat-treated teeth grip better and last longer.
- Patented reinforcing edge.
- Permalock® fastener eliminates nut and bolt failure.
- High carbon steel for superior performance and an ultimate rust preventative coating.
- Comfort grips.

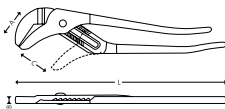

ITEM NO.	5704196+	L MM	A MM	B MM	C MM	G G	IMPA CODE
30240165	028460	165	20	12	22	138	5
30240305	028477	305	38	13	57	568	5
30240420	028484	420	65	15	108	1198	2
30240515	028491	515	76	15	140	1654	2

3050 4-IN-1 ELECTRICAL PLIER

- Model with cutter for hard wire (160 kg/mm²) and knurled gripping surface.
 - For stripping wire: 0,5 - 0,75 mm².
 - For crimping terminals: 0,5 - 1,0 mm².
 - Wire cutter: max. 0,96 mm diameter.
 - PVC coated handles.
 - Surface: Phosphatised finish with polished head.
- Material: Chrome-molybdenum steel.

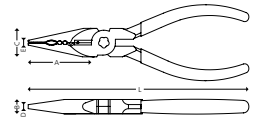

ITEM NO.	5704196+	L MM	Ø MAX MM	D X E MM	A MM	B MM	C MM	G G	IMPA CODE
30500160	013077	160	1,6	2,5 x 3,5	52,0	10,0	17,8	126	6





3060 PIPE WRENCH 90°

DIN 5234

- Swedish pattern.
- 90° serrated jaw.
- Adjustable.
- Surface: Black powder coated. Material: Chrome-vanadium steel.

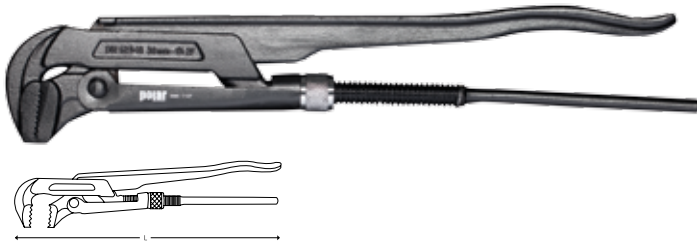

ITEM NO.	5704196+	SIZE "	MAX. OPENING MM	L MM	G	
30600034	029917	3/4"	19	282	515	1
30600100	029924	1"	25	317	705	1
30600112	029931	1 1/2"	38	427	1390	1
30600200	029948	2"	51	570	2540	1

3061 PIPE WRENCH 45°

DIN 5234

- Swedish pattern.
- 45° serrated jaw.
- Adjustable.
- Surface: Black powder coated. Material: Chrome-vanadium steel.



ITEM NO.	5704196+	SIZE "	MAX. OPENING MM	L MM	G	
30610034	029955	3/4"	19	280	455	1
30610100	029962	1"	25	340	640	1
30610112	029979	1 1/2"	38	433	1360	1
30610200	029986	2"	51	568	2630	1

3090 S/3 SET WITH 3 PLIERS

- Supplied in nylon bag.
- Content: 1 Combination plier (3001), 180 mm
1 Diagonal cutter (3002), 160 mm
1 Half-round long nose plier with straight jaws (3005), 160 mm



3
TOOLS

ITEM NO.	5704196+	G	
30900003	013046	680	1
P30900003	017013	99	1

3090 S/5 SET WITH 5 PLIERS

- Supplied in nylon bag.
- Content: 1 Combination plier (3001), 180 mm
1 Diagonal cutter (3002), 125 mm
1 Heavy-duty diagonal cutter (3004), 180 mm
1 Half-round long nose plier with straight jaws (3005), 160 mm
1 Box-joint water pump plier (3020), 250 mm



5
TOOLS

ITEM NO.	5704196+	G	
30900005	013053	1300	1
P30900005	017037	169	1



POLAR® INSULATED PLIERS

INSULATED PLIERS

3001 INSUL. COMBINATION PLIER

IEC 60900:2004, ISO 5746, DIN 5746

- Every tool is individually tested to protect up to 1000V AC.
- VDE and GS approved.
- Model with cutter for piano wire (200 kg/mm²) and knurled gripping surface.
- Ergonomic handles with wide palm support.
- Surface: Phosphatised finish with polished head.

Material: Chrome-molybdenum steel.

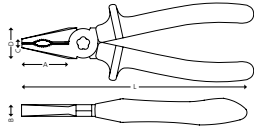

ITEM NO.	5704196+	L	Ø MAX.	A	B	C	D	G	
		MM	MM	MM	MM	MM	MM	G	
30011180	000120	180	1,8	38,0	10,0	6,0	26,5	264	6

3002 INSUL. DIAGONAL CUTTER

IEC 60900:2004, ISO 5749, DIN 5749

- Every tool is individually tested to protect up to 1000V AC.
- VDE and GS approved.
- Model with cutter for hard wire (160 kg/mm²).
- Ergonomic handles with wide palm support.
- Surface: Phosphatised finish with polished head.

Material: Chrome-molybdenum steel.

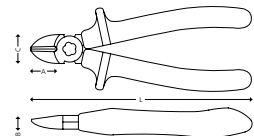

ITEM NO.	5704196+	L	Ø MAX.	A	B	C	G		IMPA CODE
		MM	MM	MM	MM	MM	G		
30021160	000137	160	1,6	20,0	10,0	19,6	184	6	611723

3004 INSUL. HEAVY-DUTY DIAGONAL CUTTER

IEC 60900:2004, ISO 5749, DIN 5749

- Every tool is individually tested to protect up to 1000V AC.
- VDE and GS approved.
- Model with cutter for piano wire (200 kg/mm²).
- Ergonomic handles with wide palm support.
- Surface: Phosphatised finish with polished head.

Material: Chrome-molybdenum steel.

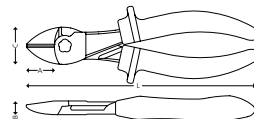

ITEM NO.	5704196+	L	Ø MAX.	A	B	C	G		IMPA CODE
		MM	MM	MM	MM	MM	G		
30041180	000144	180	1,8	21,0	11,1	28,6	260	6	611728

3005 INSUL. HALF-ROUND LONG NOSE PLIERS WITH STRAIGHT JAWS

IEC 60900:2004, ISO 5745, DIN 5745

- Every tool is individually tested to protect up to 1000V AC.
- VDE and GS approved.
- Model with cutter for hard wire (160 kg/mm²) and knurled gripping surface.
- Ergonomic handles with wide palm support.
- Surface: Phosphatised finish with polished head.

Material: Chrome-molybdenum steel.

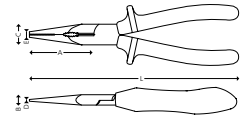

ITEM NO.	5704196+	L	Ø MAX	DXE	A	B	C	G	
		MM	MM	MM	MM	MM	MM	G	
30051160	000151	160	1,6	2,0 x 3,0	48,0	8,0	18,3	146	6
30051200	000168	200	2,0	3,0 x 4,0	70,0	10,7	21,4	242	6

3006 INSUL. HALF-ROUND NOSE PLIERS W/ BENT JAWS

IEC 60900:2004

- Every tool is individually tested to protect up to 1000V AC.
- VDE and GS approved.
- Model with cutter for hard wire (160 kg/mm²) and knurled gripping surface.
- Ergonomic handles with wide palm support.
- Surface: Phosphatised finish with polished head.

Material: Chrome-molybdenum steel.

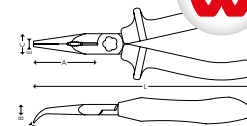

ITEM NO.	5704196+	L	Ø MAX	DXE	A	B	C	G	
		MM	MM	MM	MM	MM	MM	G	
30061160	000175	160	1,6	2,0 x 3,5	45,0	9,0	18,0	144	6
30061200	000182	200	2,0	2,5 x 4,0	65,0	10,5	21,5	244	6

3009 INSUL. WIRE STRIPPER

IEC 60900:2004

- Every tool is individually tested to protect up to 1000V AC.
- VDE and GS approved.
- Model with opening spring and adjusting screw.
- Ergonomic handles with wide palm support.
- Surface: Phosphatised finish with polished head.

Material: Chrome-molybdenum steel.

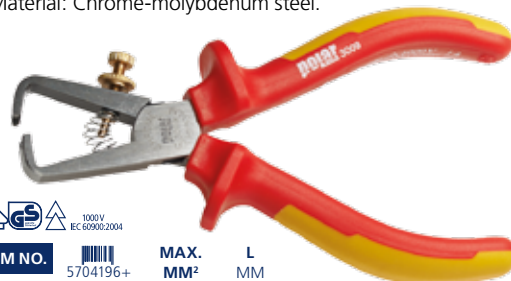
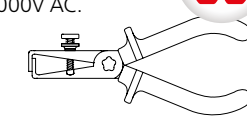

ITEM NO.	5704196+	MAX. MM ²	L	G		IMPA CODE
			MM			
30091160	000199	6	160	146	6	611742

POLAR® INSULATED PLIERS



3010 INSUL. CABLE CUTTER

IEC 60900:2004

- Every tool is individually tested to protect up to 1000V AC.
- VDE and GS approved.
- Precisely treated and sharpened jaws.
- Cuts single or multi-strand aluminum and copper cables.
- Ergonomic handles with wide palm support.
- Surface: Phosphatised finish with polished head.

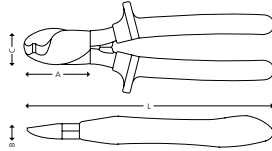

ITEM NO.	5704196+	L MM	Ø MAX.	A MM	B MM	C MM	G	6
30101160	000205	160	9 mm / 22 mm ²	45	1,3	23,4	192	6

3011 INSUL. CABLE CUTTER

IEC 60900:2004

- Every tool is individually tested to protect up to 1000V AC.
- VDE and GS approved.
- Precisely treated and sharpened jaws.
- Cuts single or multi-strand aluminum and copper cables.
- Ergonomic handles with wide palm support.
- Surface: Phosphatised finish with polished head.

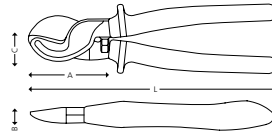

ITEM NO.	5704196+	L MM	Ø MAX.	A MM	B MM	C MM	G	6
30111250	000212	250	13 mm / 60 mm ²	67	13	43	478	6

3020 INSUL. BOX-JOINT WATER PUMP PLIER

IEC 60900:2004, ISO 8976, DIN 8976

- Every tool is individually tested to protect up to 1000V AC.
- VDE and GS approved.
- Model with 7 positions and knurled gripping surface.
- Ergonomic handles with wide palm support.
- Surface: Phosphatised finish with polished head.

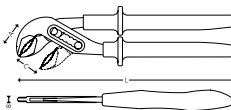

ITEM NO.	5704196+	L MM	A MM	B MM	C MM	G	6
30201250	000229	250	35,0	8,0	34,0	374	6

3091 S/4 INSULATED PLIER SET, 4 PCS.



- Supplied in nylon bag.
- Content: 1 Insulated combination plier (3001), 180 mm
- 1 insulated diagonal plier (3002), 160 mm
- 1 insulated long nose plier (3005), 160 mm
- 1 insulated wire stripper (3009), 160 mm

4
TOOLS



ITEM NO.	5704196+	G	6
30910004	023236	866	1
P30910004	027036	122	1

3091 S/7 INSULATED PLIER SET, 7 PCS.



- Supplied in nylon bag.
- Content: 1 Insulated combination plier (3001), 180 mm
- 1 Insulated diagonal plier (3002), 160 mm
- 1 Insulated long nose plier (3005), 160 mm
- 1 Insulated wire stripper (3009), 160 mm
- 1 Insulated cable cutter (3010), 160 mm
- 1 Insulated water pump plier (3020), 250 mm
- 1 Electricians Scissor (3500), 140 mm

7
TOOLS



ITEM NO.	5704196+	G	6
30910007	023243	1596	1
P30910007	027043	224	1



POLAR® PLIERS

3100 PLIERS WITH STRAIGHT JAWS - INTERNAL CIRCLIPS

- PVC coated handles.
- Surface: Phosphatised finish with polished head.
- Material: Chrome-molybdenum steel.



ITEM NO.	5704196+	Ø MIN. - MAX. MM	L MM	G	IMPA CODE
1010687	007809	8 - 25	135	77	611822
1010688	007816	19 - 60	175	127	611823

3115 PLIERS WITH NOSE BENT 90° - EXTERNAL CIRCLIPS

- PVC coated handles.
- Surface: Phosphatised finish with polished head.
- Material: Chrome-molybdenum steel.



ITEM NO.	5704196+	Ø MIN. - MAX. MM	L MM	G	IMPA CODE
31150825	007892	8 - 25	128	86	611812
31151960	007908	19 - 60	165	152	611813

3105 PLIERS WITH NOSE BENT 90° - INTERNAL CIRCLIPS

- PVC coated handles.
- Surface: Phosphatised finish with polished head.
- Material: Chrome-molybdenum steel.



ITEM NO.	5704196+	Ø MIN. - MAX. MM	L MM	G	IMPA CODE
31050825	007830	8 - 25	128	83	611832
31051960	007847	19 - 60	165	127	611833

3190 S/4 SET WITH 4 PLIERS FOR CIRCLIPS

- Supplied in nylon bag.
- Content: 1 Plier with straight jaws for internal circlips (3100), 19 - 60 mm
1 Plier with nose bent 90° for internal circlips (3105), 19 - 60 mm
1 Plier with straight jaws for external circlips (3110), 19 - 60 mm
1 Plier with nose bent 90° for external circlips (3115), 19 - 60 mm



4
TOOLS

ITEM NO.	5704196+	G	IMPA CODE
31900004	013060	740	1
P31900004	017044	163	1

Empty pouch for 3190-0004

3110 PLIERS WITH STRAIGHT JAWS - EXTERNAL CIRCLIPS

- PVC coated handles.
- Surface: Phosphatised finish with polished head.
- Material: Chrome-molybdenum steel.

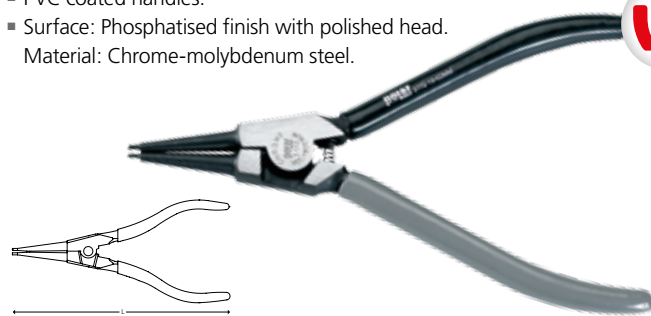

ITEM NO.	5704196+	Ø MIN. - MAX. MM	L MM	G	IMPA CODE
1010689	007861	8 - 25	135	92	611802
1010690	007878	19 - 60	175	157	611803



LOCKING PLIERS

3200 LOCKING PLIERS

- Model with curved jaws with cutter.
- Surface: Nickel plated. Material: Chrome-vanadium steel jaws.

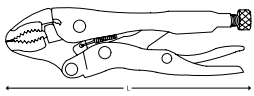

ITEM NO.		L MM	L "	A MM			IMPA CODE
	5704196+						
1010691	008004	125	5"	29	180	6	611641
1010692	008011	180	7"	41	345	6	611642
1010693	008028	250	10"	48	515	6	611644

3205 LOCKING PLIERS

- Model with long jaws.
- Surface: Nickel plated. Material: Chrome-vanadium steel jaws.

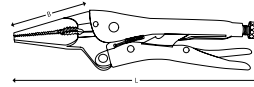

ITEM NO.		L MM	L "	A MM	B MM		
	5704196+						
32050150	008073	150	6"	57	50	175	6
32050225	008080	225	9"	70	60	370	6

3202 LOCKING PLIERS

- Model with curved jaws.
- Surface: Nickel plated. Material: Chrome-vanadium steel jaws.

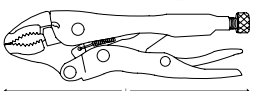

ITEM NO.		L MM	L "	A MM		
	5704196+					
32020180	008035	180	7"	41	345	6
32020250	008042	250	10"	48	515	6

3210 SHEET METAL PLIER

- Model for clamping sheet metal without gripping effort.
- Surface: Nickel plated. Material: Chrome-vanadium steel jaws.

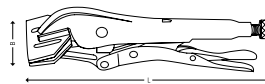

ITEM NO.		L MM	L "	A MM	B MM		
	5704196+						
32100200	008097	250	5"	40	75	695	6

3203 LOCKING PLIERS

- Model with straight jaws.
- Surface: Nickel plated. Material: Chrome-vanadium steel jaws.

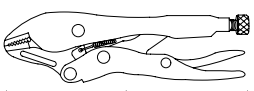

ITEM NO.		L MM	L "	A MM		
	5704196+					
32030180	008059	180	7"	43	380	6
32030250	008066	250	10"	50	600	6

3215 WELDING CLAMP

- Model with U-shaped jaws. Allows access and good visibility when welding.
- Surface: Nickel plated. Material: Chrome-vanadium steel jaws.

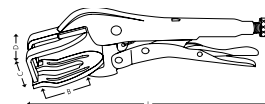

ITEM NO.		L MM	L "	A MM	B MM	C MM	D MM		
	5704196+								
32150225	008103	280	11"	55	60	90	70	845	6



POLAR® PLIERS

3220 C-CLAMP LOCKING PLIERS

- Model for clamping metal profiles.
- Surface: Nickel plated. Material: Chrome-vanadium steel jaws.

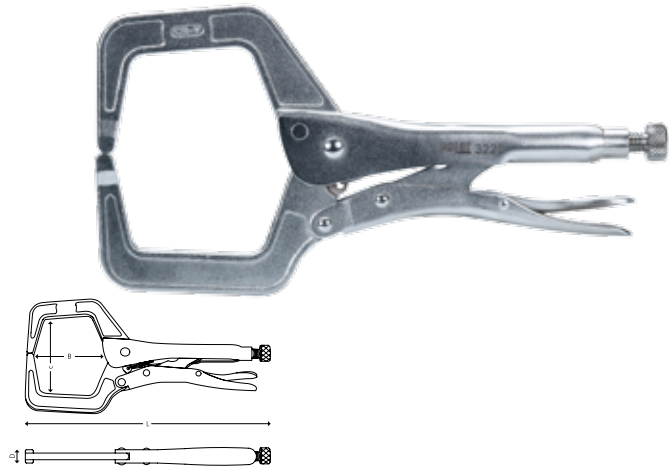

ITEM NO.	5704196+	L MM	L "	A MM	B MM	C MM	D MM	G	
32200150	008110	175	7"	45	40	50	10	235	6
32200275	008127	275	11"	80	80	95	11	720	6

3500 A ELECTRICIANS SCISSOR

- Model with plast moulded sheathing. Short blades with wire cutter.
- Surface: Nickel plated finish. Material: Carbon steel.



ITEM NO.	5704196+	L MM	A MM	G	
35000140	013084	140	45	74	4

CUTTING SHEARS

3400 METAL CUTTING SHEARS

- Internal torsion spring. Serrated edges prevent slipping.
- Plastic handle with rubber grip. Safety latch.
- Cutting capacity: Stainless steel: 0,7 mm. Cold rolled steel: 1,2 mm
- Material: Chrome-molybdenum alloy steel blades.

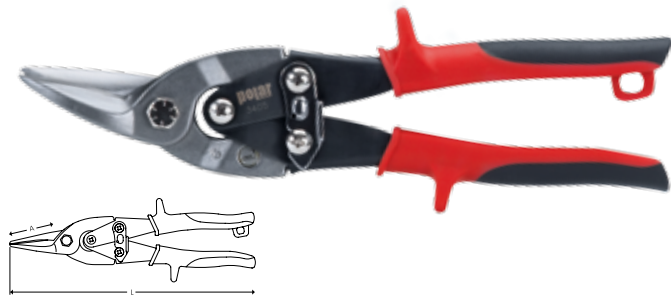

ITEM NO.	5704196+	CUT	COLOR	A MM	L MM	G	
1010694	008172	Right	Green	35	248	375	6
34050250	008189	Left	Red	35	248	375	6
1010695	008196	Straight	Yellow	35	250	380	6





FILES

3900 FLAT FILE

ISO 234, DIN 7285

- Ergonomic soft grip handle.



ITEM NO.	5704196+	FILE TYPE	SHAPE	A X B MM	L MM	G	
39000200	013879	Medium		20 x 5,0	200	211	10

3904 TRIANGULAR FILE

ISO 234, DIN 7285

- Ergonomic soft grip handle.



ITEM NO.	5704196+	FILE TYPE	SHAPE	A MM	L MM	G	
39040200	013916	Medium		13	200	203	10

3901 ROUND FILE

ISO 234, DIN 7285

- Ergonomic soft grip handle.



ITEM NO.	5704196+	FILE TYPE	SHAPE	Ø MM	L MM	G	
39010200	013886	Medium		8	200	158	10

3990 S5 FILE SET

- Second cut.
- Supplied in nylon bag.



**5
TOOLS**

3902 HALFRound FILE

ISO 234, DIN 7285

- Ergonomic soft grip handle.



ITEM NO.	5704196+	FILE TYPE	SHAPE	A X B MM	L MM	G	
39020200	013893	Medium		20 x 6,5	200	229	10

3903 SQUARE FILE

ISO 234, DIN 7285

- Ergonomic soft grip handle.



ITEM NO.	5704196+	FILE TYPE	SHAPE	A X A MM	L MM	G	
39030200	013909	Medium		7 x 7	200	150	10

ITEM NO.	5704196+	QTY.	TYPE	G	
39900005	013862	5	Flat - Round - Halfround - Square - Triangular	1084	1
P39900005	017051	1	Empty pouch for 3990-0005	137	1

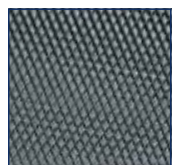



POLAR® SCREWDRIVERS AND BITS



Ergonomic soft
grip handle



Chrome-molybdenum
steel blade

Chrome plated blade
with burnished tip



SCREWDRIVERS

POLAR® screwdrivers offer a great combination of power and comfort.

- Unique handle shape providing excellent grip and superior force.
- Bi-material gives you firm grip – even in the greasiest shop environments.
- The tip types are marked on each handle to quickly find the right type for the job.
- The blade is made of chrome-molybdenum steel for the highest torque performance.
- The wide range includes also screwdrivers with go-through blades and insulated screwdrivers.

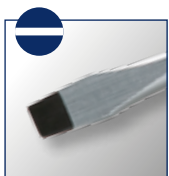

Slotted



Phillips®



Pozidriv®



Torx®



Tamper resist Torx®



With Ball-point

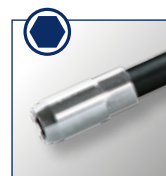

Hexagon

POLAR® SCREWDRIVERS AND BITS



SCREWDRIVERS

4000 SCREWDRIVERS FOR SLOTTED HEAD SCREWS

ISO 2380, DIN 5264

- Ergonomic soft grip handle.
 - Surface: Chrome plated blade with burnished tip.
- Material: Chrome-molybdenum steel blade.

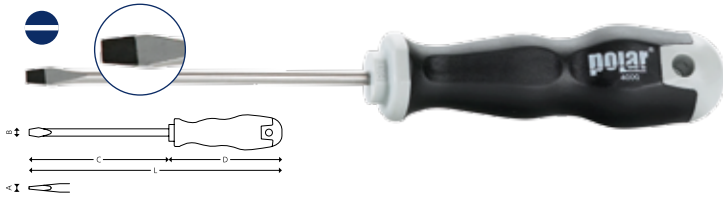

ITEM NO.	5704196+	A X B X C MM	D MM	L MM	G	IMPACT CODE
40000030	006697	0,5 x 3 x 75	85	160	30	10
40000130	030104	0,5 x 3 x 100	85	185	33	10
40000040	006703	0,8 x 4 x 100	105	205	56	10
40000155	027227	1,0 x 5,5 x 100	105	205	66	10
40000055	006710	1,0 x 5,5 x 125	105	230	69	10
40000165	027234	1,2 x 6,5 x 100	115	215	92	10
40000065	006727	1,2 x 6,5 x 150	115	265	102	10
40000180	027241	1,2 x 8,0 x 150	125	280	164	10
40000080	006734	1,2 x 8 x 175	125	300	172	10
40000100	027258	1,6 x 10 x 200	125	330	224	10

4002 SCREWDRIVERS FOR SLOTTED HEAD SCREWS

ISO 2380, DIN 5264

- Supplied with round blade.
 - Ergonomic soft grip handle.
 - Surface: Chrome plated blade with burnished tip.
- Material: Chrome-molybdenum steel blade.

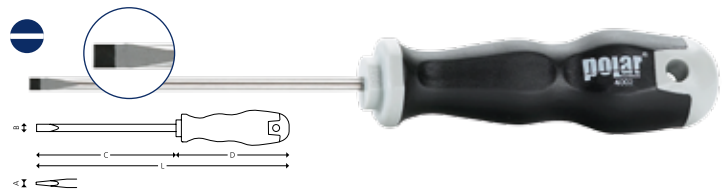

ITEM NO.	5704196+	A X B X C MM	D MM	L MM	G	IMPACT CODE
40020030	027272	0,5 x 3,0 x 75	85	160	28	10
40020040	027289	0,8 x 4,0 x 100	105	205	56	10
40020055	027296	1,0 x 5,5 x 100	105	205	70	10
40020065	027302	1,2 x 6,5 x 150	115	265	110	10

4001 SCREWDRIVERS FOR SLOTTED HEAD SCREWS

- Supplied with go-through blade and hexagonal bolster.
 - Ergonomic soft grip handle with impact cap.
 - Surface: Chrome plated blade with burnished tip.
- Material: Chrome-molybdenum steel blade.

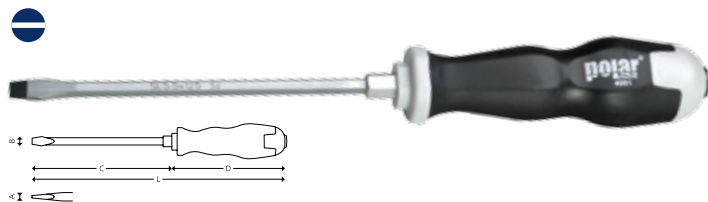

ITEM NO.	5704196+	A X B X C MM	D MM	L MM	G	IMPACT CODE
40010055	016597	1,0 x 5,5 x 125	110	8	235	98
40010065	016603	1,2 x 6,5 x 150	120	10	245	137
40010180	027265	1,2 x 8,0 x 150	130	13	275	220
40010080	016610	1,2 x 8 x 175	130	13	305	227
40010100	016627	1,6 x 10 x 200	130	16	330	278
40010120	016634	2 x 12 x 200	130	16	330	318

4003 STUBBY SCREWDRIVERS FOR SLOTTED HEAD SCREWS

ISO 2380, DIN 5264

- Ergonomic soft grip handle.
 - Surface: Chrome plated blade with burnished tip.
- Material: Chrome-molybdenum steel blade.



ITEM NO.	5704196+	A X B X C MM	D MM	L MM	G	IMPACT CODE
40030055	006758	1,0 x 5,5 x 25	50	75	36	10
40030065	006765	1,0 x 6,5 x 25	50	75	40	10

4005 EXTRA LONG SCREWDRIVERS FOR SLOTTED HEAD SCREWS

ISO 2380, DIN 5264

- Supplied with round blade.
 - Ergonomic soft grip handle.
 - Surface: Chrome plated blade with burnished tip.
- Material: Chrome-molybdenum steel blade.

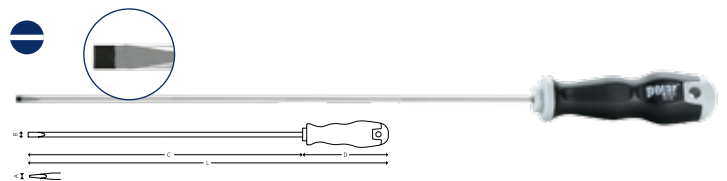

ITEM NO.	5704196+	A X B X C MM	D MM	L MM	G	IMPACT CODE
40050030	030036	0,5 x 3,0 x 300	85	385	43	10
40050040	030043	0,8 x 4,0 x 400	105	505	88	10
40050055	030050	1,0 x 5,5 x 400	105	505	123	10
40050065	030067	1,2 x 6,5 x 400	115	515	176	10

POLAR® SCREWDRIVERS AND BITS



4010 PH SCREWDRIVERS FOR PHILLIPS® HEAD SCREWS

ISO 8764, DIN 5260

- Ergonomic soft grip handle.
 - Surface: Chrome plated blade with burnished tip.
- Material: Chrome-molybdenum steel blade.



ITEM NO.	5704196+	PH	C MM	D MM	L MM	G	10	IMPA CODE
40100100	006772	0	60	85	145	29	10	612272
40100101	006789	1	80	105	185	60	10	612273
40100102	006796	2	100	115	215	86	10	612274
40100112	027319	2	150	115	265	102	10	
40100103	006802	3	150	125	275	165	10	612275
40100104	030111	4	200	125	325	228	10	

4013 PH STUBBY SCREWDRIVERS FOR PHILLIPS® HEAD SCREWS

ISO 8764, DIN 5260

- Ergonomic soft grip handle.
 - Surface: Chrome plated blade with burnished tip.
- Material: Chrome-molybdenum steel blade.

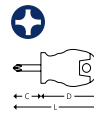

ITEM NO.	5704196+	PH	C MM	D MM	L MM	G	10	IMPA CODE
40130101	006819	1	25	50	75	34	10	612325
40130102	006826	2	25	50	75	38	10	612326

4015 PH EXTRA LONG SCREWDRIVERS FOR PHILLIPS® HEAD SCREWS

ISO 8764, DIN 5260

- Ergonomic soft grip handle.
 - Surface: Chrome plated blade with burnished tip.
- Material: Chrome-molybdenum steel blade.

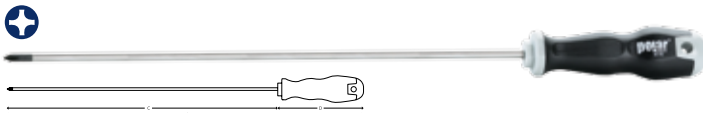

ITEM NO.	5704196+	PH	C MM	D MM	L MM	G	10
40150100	030074	0	300	85	385	43	10
40150101	030081	1	400	105	505	113	10
40150102	030098	2	400	115	515	177	10

4011 PH SCREWDRIVERS FOR PHILLIPS® HEAD SCREWS

- Supplied with go-through blade and hexagonal bolster.
 - Ergonomic soft grip handle with impact cap.
 - Surface: Chrome plated blade with burnished tip.
- Material: Chrome-molybdenum steel blade.



ITEM NO.	5704196+	PH	C MM	D MM	W	L MM	G	10	IMPA CODE
40110101	016641	1	80	110	8	190	88	6	612295
40110102	016658	2	100	120	10	220	131	6	612296
40110103	016665	3	150	130	13	280	219	6	612297
40110104	016672	4	200	130	16	330	315	6	912298
40110114	027326	4	300	130	16	430	388	9	





4020 PZ SCREWDRIVERS FOR POZIDRIV® HEAD SCREWS

ISO 8764, DIN 5260

- Ergonomic soft grip handle.
 - Surface: Chrome plated blade with burnished tip.
- Material: Chrome-molybdenum steel blade.



ITEM NO.	5704196+	PZ	C MM	D MM	L MM	G	IMPACT CODE
40200101	006833	1	80	105	185	60	10 612451
40200102	006840	2	100	115	215	86	10 612452
40200103	006857	3	150	125	275	165	10 612453

4021 PZ SCREWDRIVERS FOR POZIDRIV® HEAD SCREWS

- Supplied with go-through blade and hexagonal bolster.
 - Ergonomic soft grip handle with impact cap.
 - Surface: Chrome plated blade with burnished tip.
- Material: Chrome-molybdenum steel blade.

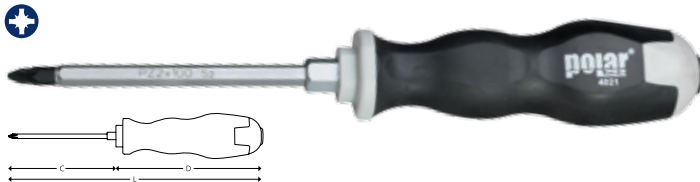

ITEM NO.	5704196+	PZ	C MM	D MM	MM	L MM	G
40210101	016689	1	80	110	8	190	88 6
40210102	016696	2	100	120	10	220	131 6
40210103	016702	3	150	130	13	280	219 6
40210404	016719	4	200	130	16	330	315 6

4023 PZ STUBBY SCREWDRIVERS FOR POZIDRIV® HEAD SCREWS

ISO 8764, DIN 5260

- Ergonomic soft grip handle.
 - Surface: Chrome plated blade with burnished tip.
- Material: Chrome-molybdenum steel blade.



ITEM NO.	5704196+	PH	C MM	D MM	L MM	G
40230101	006864	1	25	50	75	34 10
40230201	006871	2	25	50	75	38 10

4090 A SCREWDRIVER SET - 7 PCS.

- Supplied in carton box.



ITEM NO.	5704196+	QTY.	SIZE	G
40900007	000800	7	3 x 75 - 4 x 100 - 5,5 x 125 PH1 x 80 - PH2 x 100 PZ1 x 80 - PZ2 x 100	640 1

4090 SCREWDRIVER SET - 10 PCS.

- Supplied in carton box.



ITEM NO.	5704196+	QTY.	SIZE	G
40900010	000824	10	3 x 75 - 4 x 100 - 5,5 x 125 - 6,5 x 150 PH1 x 80 - PH2 x 100 - PH3 x 150 PZ1 x 80 - PZ2 x 100 - PZ3 x 150	1115 1



4090 B **SCREWDRIVER SET - 7 PCS.**

▪ Supplied in carton box.



7 TOOLS

ITEM NO.	5704196+	QTY.	SIZE	G	1
40901007	000817	7	3 x 75 - 4 x 100 - 5,5 x 125 - 6,5 x 150 - PH1 x 80 - PH2 x 100 - PH3 x 150	755	1

4091 **SCREWDRIVER SET WITH IMPACT CAP - 6 PCS.**

▪ Supplied in carton box.



6 TOOLS

ITEM NO.	5704196+	QTY.	SIZE	G	1
40910006	016740	6	5,5 x 125 - 6,5 x 150 - 10 x 200 PH1 x 80 - PH2 x 100 - PH3 x 150	1090	1

4090 **SCREWDRIVER SET - 12 PCS.**

▪ Supplied in plastic case.



12 TOOLS

ITEM NO.	5704196+	QTY.	SIZE	G	1
40900012	024905	12	3 x 75 - 4 x 100 - 5,5 x 125 - 6,5 x 150 PH1 x 80 - PH2 x 100 - PH3 x 150 PZ1 x 80 - PZ2 x 100 - PZ3 x 150 Stubby screwdriver 5,5 x 25 Stubby screwdriver PH2 x 25	1682	1





POLAR® SCREWDRIVERS AND BITS



4091 SCREWDRIVER SET WITH IMPACT CAP - 7 PCS.

▪ Supplied in carton box.



7
TOOLS

ITEM NO.	5704196+	QTY.	SIZE	G	1
40910007	016726	7	5,5 x 125 - 6,5 x 150 - 8 x 175 - 10 x 200 12 x 200 - PH2 x 100 - PH3 x 150	1580	1

4091 SCREWDRIVER SET WITH IMPACT CAP - 10 PCS.

▪ Supplied in carton box.



10
TOOLS

ITEM NO.	5704196+	QTY.	SIZE	G	1
40910010	016733	10	5,5 x 125 - 6,5 x 150 - 8 x 175 - 10 x 200 PH1 x 80 - PH2 x 100 - PH3 x 150 PZ1 x 80 - PZ2 x 100 - PZ3 x 150	1840	1

4031 TX SCREWDRIVERS FOR TORX® HEAD SCREWS

▪ Ergonomic soft grip handle.

▪ Surface: Chrome plated blade with burnished tip.
Material: Chrome-molybdenum steel blade.



ITEM NO.	5704196+	TORX® NO.	MM	C MM	D MM	L MM	G	10
40310008	015187	T8	2,31	60	85	145	31	10
40310010	015194	T10	2,74	80	105	185	56	10
40310015	015200	T15	3,27	80	105	185	56	10
40310020	015217	T20	3,86	100	105	205	58	10
40310025	015224	T25	4,43	100	105	205	68	10
40310027	015231	T27	4,99	115	115	230	98	10
40310030	015248	T30	5,52	115	115	230	98	10
40310040	015255	T40	6,65	130	115	245	118	10

4090 SCREWDRIVER SET FOR TORX® HEAD SCREWS - 8 PCS.

▪ Supplied in carton box.



8
TOOLS

ITEM NO.	5704196+	QTY.	SIZE	G	1
40901008	015330	8	TX T8 x 60 - T10 x 80 - T15 x 80 - T20 x 100 - T25 x 100 - T27 x 115 - T30 x 115 - T40 x 130	740	1

POLAR® SCREWDRIVERS AND BITS



4030 STX SCREWDRIVERS FOR TAMPER RESISTANT® TORX® HEAD SCREWS

- Ergonomic soft grip handle.
- Surface: Chrome plated blade with burnished tip.
Material: Chrome-molybdenum steel blade.



ITEM NO.	5704196+	TORX® NO.	MM	C MM	D MM	L MM	G	
40300008	006888	T8	2,31	60	85	145	31	10
40300010	006895	T10	2,74	80	85	165	56	10
40300015	006901	T15	3,27	80	105	185	56	10
40300020	006918	T20	3,86	100	105	205	58	10
40300025	006925	T25	4,43	100	105	205	68	10
40300027	006932	T27	4,99	115	115	230	98	10
40300030	006949	T30	5,52	115	115	230	98	10
40300040	006956	T40	6,65	130	115	245	118	10

4035 HBP SCREWDRIVERS WITH BALL-POINT FOR HEX HEAD SCREWS

- Ergonomic soft grip handle.
- Surface: Chrome plated blade with burnished tip.
Material: Chrome-molybdenum steel blade.



ITEM NO.	5704196+	SIZE MM	C MM	D MM	L MM	G	
40350025	015262	2,5	100	85	185	33	10
40350030	015279	3	100	85	185	34	10
40350040	015286	4	100	105	205	68	10
40350050	015293	5	100	105	205	70	10
40350060	015309	6	125	115	240	105	10
40350080	015316	8	150	128	278	177	10
40350100	015323	10	150	128	278	229	10

4090 SCREWDRIVER SET FOR TAMPER RESISTANT® TORX® HEAD SCREWS

- Supplied in carton box.



ITEM NO.	5704196+	QTY.	SIZE	G	
40900008	000831	8	STX T8 x 60 - T10 x 80 - T15 x 80 - T20 x 100 - T25 x 100 - T27 x 115 - T30 x 115 - T40 x 130	740	1

4042 F FLEXIBLE HEXAGONAL NUT DRIVERS

- Ergonomic soft grip handle.
- Maximum torque: 10 Nm.
- Surface: Chrome plated finish. Material: Chrome-vanadium steel.



ITEM NO.	5704196+	SIZE "/>						
40420014	006987	1/4"	160	115	275	135	10	
40420060	006963	6 mm	160	115	275	135	10	
40420070	006970	7 mm	160	115	275	135	10	612376

4043 M 1/4" MAGNETIC BIT HOLDING SCREWDRIVER

- Ergonomic soft grip handle.
- Model with 6 mm hexagonal blade.
- Surface: Chrome plated finish. Material: Chrome-vanadium steel.



ITEM NO.	5704196+	SIZE "	C MM	D MM	L MM	G	
40430014	006994	1/4"	100	115	215	106	10

POLAR® SCREWDRIVERS AND BITS



INSULATED SCREWDRIVERS

4200 INSULATED SCREWDRIVERS FOR SLOTTED HEAD SCREWS

IEC 60900:2004, ISO 2380, DIN 5264

- Every tool is individually tested to protect up to 1000V AC.
- VDE and GS approved.
- Insulation moulded directly onto the blade.
- Ergonomic soft grip handle.
- Cylindrical blade.
- Surface: Insulated blade with burnished tip.
- Material: Chrome-molybdenum steel blade.

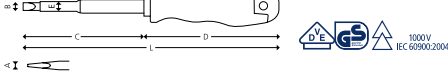

ITEM NO.	5704196+	A X B X C MM	D MM	E MM	L MM	G	
42000025	022949	0,2 x 2,5 x 75	85	4,2	160	28	10
42000030	022956	0,5 x 3,0 x 100	85	4,7	185	32	10
42000035	022963	0,8 x 3,5 x 100	85	5,3	185	34	10
42000040	022970	0,8 x 4,0 x 100	105	6,0	215	58	10
42000055	022987	1,0 x 5,5 x 125	105	7,4	230	78	10
42000065	022994	1,2 x 6,5 x 150	115	8,5	270	114	10
42000080	023007	1,2 x 8,0 x 175	125	9,9	300	185	10

4220 INSULATED SCREWDRIVERS FOR POZIDRIV® HEAD SCREWS

IEC 60900:2004, ISO 8764, DIN 5260

- Every tool is individually tested to protect up to 1000V AC.
- VDE and GS approved.
- Insulation moulded directly on to the blade.
- Ergonomic soft grip handle.
- Surface: Insulated blade with burnished tip.
- Material: Chrome-molybdenum steel blade.



ITEM NO.	5704196+	PZ	C MM	D MM	E MM	L MM	G	
42200100	023052	0	60	85	4,7	145	29	10
42200101	023069	1	80	105	6,8	190	64	10
42200102	023076	2	100	115	7,8	215	94	10
42200103	023083	3	150	125	9,9	280	173	10

4210 INSULATED SCREWDRIVERS FOR PHILLIPS® HEAD SCREWS

IEC 60900:2004, ISO 8764, DIN 5260

- Every tool is individually tested to protect up to 1000V AC.
- VDE and GS approved.
- Insulation moulded directly on to the blade.
- Ergonomic soft grip handle.
- Surface: Insulated blade with burnished tip.
- Material: Chrome-molybdenum steel blade.



ITEM NO.	5704196+	PH	C MM	D MM	E MM	L MM	G	
42100100	023014	0	60	85	4,7	145	29	10
42100101	023021	1	80	105	6,8	190	64	10
42100102	023038	2	100	115	7,8	215	94	10
42100103	023045	3	150	125	9,9	280	173	10

4202 VOLTAGE TESTER

- VDE and GS approved.
- Transparent handle with clip.
- Insulation moulded directly onto the blade.
- Cylindrical blade.
- Surface: Insulated chrome plated blade.
- Material: Chrome-vanadium steel blade.

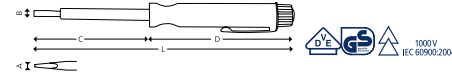

ITEM NO.	5704196+	A X B X C MM	D MM	L MM	G	
42020030	023090	0,5 x 3,0 x 60	80	140	16	10





POLAR®

4290 INSULATED SCREWDRIVER SET - 6 PCS.

■ Supplied in carton box.



6 TOOLS



ITEM NO. 5704196+

QTY. SIZE



42900006 023106

6 2.5 x 75 - 3.5 x 100 - 4.0 x 100 - 5.5 x 125
PH1 x 80 - PH2 x 100

492 1

4290 INSULATED SCREWDRIVER SET - 9 PCS.

■ Supplied in carton box.



9 TOOLS



ITEM NO. 5704196+

QTY. SIZE



42900009 023113

9 2.5 x 75 - 4.0 x 100 - 5.5 x 125 - 6.5 x 150
PH1 x 80 - PH2 x 100
PZ1 x 80 - PZ2 x 100
Voltage tester 110-250 V

790 1



POLAR® SCREWDRIVERS AND BITS



SCREWDRIVERS

4045 S/5 3-IN-1 RATCHET BIT SCREWDRIVER

- 3 different handle positions.
- Magnetic bit holding ratchet screwdriver with 10 teeth.
- 5 pcs. bit holder inside the handle.
- Surface: Chrome plated finish. Material: Chrome-vanadium steel.
- Content:
 - 1 Bits for slotted head screws 4514 1/4" 6 mm
 - 2 Bits for Phillips® screws 4514 1/4" PH 1 - 2
 - 2 Bits for Pozidriv® screws 4514 1/4" PZ 1 - 2

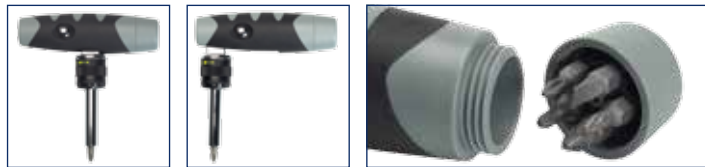

ITEM NO.	5704196+
40450005	019024

DIMENSIONS	G	
MM		
200 x 35 mm	250	1

4400 SCREWDRIVERS FOR SLOTTED HEAD SCREWS

- Ergonomic soft grip handle.
- Revolving head for precision action.
- Surface: Chrome plated blade with burnished tip.
Material: Chrome-molybdenum steel blade.



ITEM NO.	5704196+	A X B X C	D	L	G	
		MM	MM	MM		
44000010	014937	0,2 x 1 x 40	98	138	12	10
44000015	014944	0,4 x 1,5 x 40	98	138	12	10
44000018	014951	0,4 x 1,8 x 75	98	173	13	10
44000020	014968	0,5 x 2 x 75	98	173	13	10
44000025	014975	0,5 x 2,5 x 75	98	173	14	10
44000030	014982	0,5 x 3 x 75	98	173	16	10

4410 PH SCREWDRIVERS FOR PHILLIPS® HEAD SCREWS

- Ergonomic soft grip handle.
- Revolving head for precision action.
- Surface: Chrome plated blade with burnished tip.
Material: Chrome-molybdenum steel blade.



ITEM NO.	5704196+	PH	C	D	L	G	
			MM	MM	MM		
44100000	014999	000	40	98	138	12	10
44100010	015002	00	75	98	173	14	10
44100100	015019	0	75	98	173	16	10
44100101	015026	1	75	98	173	21	10

4431 TX SCREWDRIVERS FOR TORX® HEAD SCREWS

- Ergonomic soft grip handle.
- Revolving head for precision action.
- Surface: Chrome plated blade with burnished tip.
Material: Chrome-molybdenum steel blade.



ITEM NO.	5704196+	TORX® NO.	MM	C	D	L	G	
			MM	MM	MM	MM		
44310005	015095	T5	1,35	40	98	138	12	10
44310006	015101	T6	1,70	40	98	138	12	10
44310007	015118	T7	1,99	40	98	138	13	10
44310008	015125	T8	2,31	40	98	138	13	10
44310009	015132	T9	2,50	75	98	173	16	10
44310010	015149	T10	2,72	75	98	173	16	10
44310015	015156	T15	3,26	75	98	173	19	10
44310020	015163	T20	3,86	75	98	173	21	10

4430 STX SCREWDRIVERS FOR TAMPER RESISTANT® TORX® HEAD SCREWS

- Ergonomic soft grip handle.
- Revolving head for precision action.
- Surface: Chrome plated blade with burnished tip.
Material: Chrome-molybdenum steel blade.



ITEM NO.	5704196+	TORX® NO.	MM	C	D	L	G	
			MM	MM	MM	MM		
44300007	015033	T7	1,99	40	98	138	13	10
44300008	015040	T8	2,31	40	98	138	13	10
44300009	015057	T9	2,50	75	98	173	16	10
44300010	015064	T10	2,72	75	98	173	16	10
44300015	015071	T15	3,26	75	98	173	19	10
44300020	015088	T20	3,86	75	98	173	21	10



POLAR® SCREWDRIVERS AND BITS



4490 S/8 SCREWDRIVER SET

▪ Supplied in nylon bag.



8
TOOLS

ITEM NO.	5704196+	QTY.	SIZE	G	
44900008	014913	8	1,0 x 40 - 1,5 x 40 - 1,8 x 78 - 2,0 x 75 - 2,5 x 75 PH00 x 75 - PH0 x 75 - PH1 x 75	154	1
P44900008	027050	1	Empty pouch for 4490-0008	46	1

4490TXS/8 SCREWDRIVER SET FOR TORX® HEAD SCREWS

▪ Supplied in nylon bag.



8
TOOLS

ITEM NO.	5704196+	QTY.	SIZE	G	
44901008	014920	8	TX T5 x 40 - T6 x 40 - T7 x 40 - T8 x 40 - T9 x 75 T10 x 75 - T15 x 75 - T20 x 75	161	1
P44901008	027067	1	Empty pouch for 4490-1008	46	1

4490 A 1/4" PRECISION BITS AND SOCKET WRENCH SET

ITEM NO. 44900031

▪ Set in metal box with 19 pcs. 4 mm bits, 10 pcs. 1/4" sockets, 1/4" adaptor and bit holding screwdriver.

▪ 31 tools.

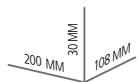

0,61 KG

5704196.015170

1

CONTENT:

QTY.	DESCRIPTION	SIZE
4	4 mm bits for slotted head screws	2 - 2.5 - 3 - 4 mm
2	4 mm bits for Phillips® screws	PH 00 - 0
2	4 mm bits for Pozidriv® screws	PZ 00 - 0
5	4 mm bits for Torx® screws	TX T6 - T7 - T8 - T9 - T10
3	4 mm bits for hex head screws	H 1.5 - 2 - 2.5
3	4 mm bits for hex head screws	HBP 1.5 - 2 - 2.5
5	1/4" 6-point sockets	3.2 - 4 - 5 - 5.5 - 7 mm
5	1/4" sockets for Torx® screws	NTX E4 - E5 - E6 - E7 - E8
1	Adaptor	4 mm x 1/4"
1	Bit holding screwdriver	4 mm



31
TOOLS





L-SHAPED WRENCHES



Practical holder

Material: Chrome-vanadium steel

Available with different shapes and sizes

4100 METRIC HEXAGON KEYS

ISO 2936, DIN 911

■ Surface: Phosphatised finish. Material: Chrome-vanadium steel.



ITEM NO.	5704196+	SIZE MM	A MM	L MM	G	IMP CODE
41000015	012797	1,5	14	45	1	611242
41000002	012803	2	15	50	2	611243
41000025	012810	2,5	18	55	3	611245
41000003	012827	3	20	62	5	611246
41000004	012834	4	23	70	10	611247
41000005	012841	5	29	80	18	611248
41000006	012858	6	32	90	30	611249
41000007	012865	7	34	95	43	611250
41000008	012872	8	36	100	60	611251
41000009	012889	9	38	105	80	611252
41000010	012896	10	40	112	105	611253
41000012	012902	12	45	125	170	611254
41000014	012919	14	54	140	265	611255
41000017	012926	17	61	160	440	611257
41000019	012933	19	70	180	625	611258
41000022	012940	22	80	200	935	611260
41000024	012957	24	90	225	1250	611262

4105 BP METRIC LONG HEXAGON KEYS WITH BALL-POINT

■ The ball-point provides a working angle up to 25°.

■ Surface: Phosphatised finish. Material: Chrome-vanadium steel.



ITEM NO.	5704196+	SIZE MM	A MM	L MM	G	IMP CODE
41050015	012575	1,5	15	74	1	1
41050002	012582	2	16	80	3	1
41050025	012599	2,5	18	87	5	1
41050003	012605	3	20	96	7	1
41050004	012612	4	24	107	14	1
41050005	012629	5	28	120	26	1
41050006	012636	6	32	136	42	1
41050007	012643	7	34	144	60	1
41050008	012650	8	36	154	84	1
41050010	012667	10	40	172	147	1
41050012	028286	12	56	215	240	1
41050014	028293	14	69	245	370	1

POLAR® SCREWDRIVERS AND BITS



4105 IBP INCH LONG HEXAGON KEYS WITH BALL-POINT

- The ball-point provides a working angle up to 25°.
- Surface: Phosphatised finish. Material: Chrome-vanadium steel.



ITEM NO.	5704196+	SIZE MM	A MM	L MM	G	
41051002	012674	1/16"	15	74	1	1
41051025	012681	5/64"	16	80	3	1
41051003	012698	3/32"	18	87	4	1
41051035	012704	7/64"	19	92	6	1
41051004	012711	1/8"	20	98	8	1
41051045	012728	9/64"	22	104	11	1
41051005	012735	5/32"	24	110	15	1
41051006	012742	3/16"	28	120	23	1
41051007	012759	7/32"	30	130	34	1
41051008	012766	1/4"	32	141	48	1
41051010	012773	5/16"	36	154	83	1
41051012	012780	3/8"	40	172	133	1

4195 LS/9 LONG METRIC HEXAGON KEY SET WITH BALL-POINT

- Supplied in plastic holder.



ITEM NO.	5704196+	QTY.	SIZE	G	IMPA CODE
41950009	012537	9	4105 BP 1.5-2-2.5-3-4-5-6-8-10 mm	356	1 611281



4131 TX LONG KEY FOR TORX® HEAD SCREWS

- Surface: Phosphatised finish. Material: Chrome-vanadium steel.



ITEM NO.	5704196+	TORX® NO.	MM	A MM	L MM	G	
41310008	019260	T8	2,31	18	83	6	10
41310009	019277	T9	2,50	19	85	7	10
41310010	019284	T10	2,74	20	88	7	10
41310015	019291	T15	3,27	21	92	8	10
41310020	019307	T20	3,86	23	98	12	10
41310025	019314	T25	4,43	25	104	18	10
41310027	019321	T27	4,99	27	110	19	10
41310030	019338	T30	5,52	30	119	28	10
41310040	019345	T40	6,65	32	130	40	10
41310045	019352	T45	7,82	36	140	67	10
41310050	019369	T50	8,83	40	160	78	10

4195 LIS/12 LONG INCH HEXAGON KEY SET WITH BALL-POINT

- Supplied in plastic holder.



ITEM NO.	5704196+	QTY.	SIZE	G	IMPA CODE
41951012	012544	12	4105 BP 1/16- 5/64- 3/32- 7/64- 1/8- 9/64- 5/32- 3/16- 7/32- 1/4- 5/16- 3/8"	395	1 611282



4190 LTXS/9 LONG KEY SET FOR TORX® HEAD SCREWS

- Supplied in plastic holder.



ITEM NO.	5704196+	QTY.	SIZE	G	IMPA CODE
41906009	012551	9	4131 TX T8-T10-T15-T20-T25-T27-T30-T40-T50	250	1



POLAR® SCREWDRIVERS AND BITS



4195 FS/8 METRIC HEXAGON KEY SET WITH BALL-POINT

- Compact holder with comfortable grip.



ITEM NO.	5704196+	QTY.	SIZE	G	1
41950008	012506	8	1.5 - 2 - 2.5 - 3 - 4 - 5 - 6 - 8 mm	168	1

4190 FTXS/8 KEY SET FOR TORX® HEAD SCREWS

- Compact holder with comfortable grip.



ITEM NO.	5704196+	QTY.	SIZE	G	1
41906008	012520	8	TX T9 - T10 - T15 - T20 - T25 - T27 - T30 - T40	162	1

4195 FIS/9 INCH HEXAGON KEY SET

- Compact holder with comfortable grip.



ITEM NO.	5704196+	QTY.	SIZE	G	1
41951009	012513	9	5/64 - 3/32 - 7/64 - 1/8 - 9/64 - 5/32 - 3/16 - 7/32 - 1/4"	154	1

4190 S/30 METRIC AND INCH HEXAGON KEY SET

- Supplied in plast box.

- Content:

15 Metric hexagon keys:

0.7 - 0.9 - 1.3 - 1.5 - 2 - 2.5 - 3 - 4 - 4.5 - 5 - 5.5 - 6 - 7 - 8 - 10 mm

15 Inch hexagon keys:

0.028 - 0.035 - 0.05 - 1/16 - 5/64 - 3/32 - 7/64 - 1/8 - 9/64 - 5/32 - 3/16 - 7/32 - 1/4 - 5/16 - 3/8"



ITEM NO.	5704196+	DIMENSIONS	KG	1
41900030	012568	130 x 190 x 33 mm	0,85	1

POLAR® SCREWDRIVERS AND BITS



4107 T-HANDLE HEX SCREWDRIVERS

Material: Silicon alloy steel (S2).

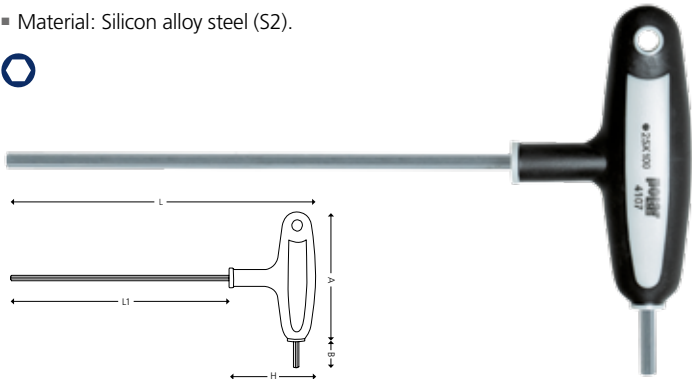

ITEM NO.	5704196+	SIZE MM	A MM	B MM	H MM	L MM	L1 MM	G	
41070002	028606	2	90	18	60	160	100	39	10
41070025	028613	2,5	90	18	60	160	100	42	10
41070003	028620	3	90	18	60	160	100	46	10
41070004	028637	4	90	18	60	210	150	60	10
41070005	028644	5	90	18	60	210	150	75	10
41070006	028651	6	115	20	68	218	150	119	10
41070008	028675	8	115	20	68	268	200	187	10
41070010	028682	10	115	20	68	268	200	267	10

4108 T-HANDLE HEX SCREWDRIVERS WITH BALL POINT

Material: Silicon alloy steel (S2).

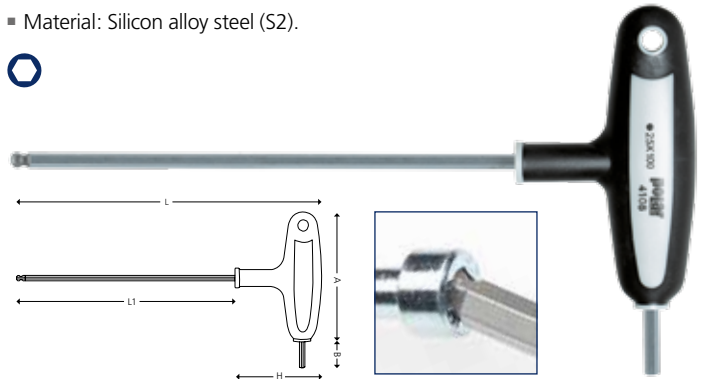

ITEM NO.	5704196+	SIZE MM	A MM	B MM	H MM	L MM	L1 MM	G	
41080002	030128	2	90	18	60	160	100	39	10
41080025	030135	2,5	90	18	60	160	100	42	10
41080003	030142	3	90	18	60	160	100	46	10
41080004	030159	4	90	18	60	210	150	60	10
41080005	030166	5	90	18	60	210	150	75	10
41080006	030173	6	115	20	68	218	150	119	10
41080008	030180	8	115	20	68	268	200	187	10
41080010	030197	10	115	20	68	268	200	267	10

4197 T-HANDLE SCREWDRIVER SET - HEX

Supplied in practical holder.



ITEM NO.	5704196+	QTY.	SIZE MM	G	
41970008	028682	8	2 - 2,5 - 3 - 4 - 5 - 6 - 8 - 10 mm	1140	1



POLAR® SCREWDRIVERS AND BITS



4137 T-HANDLE TORX® SCREWDRIVERS

Material: Silicon alloy steel (S2).

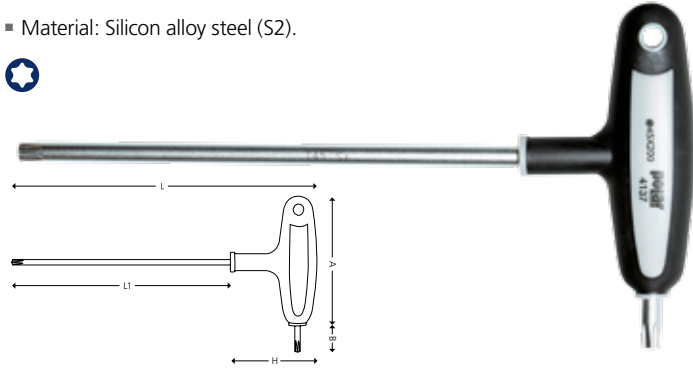

ITEM NO.	5704196+	TORX® NO.	MM	A MM	B MM	H MM	L MM	L1 MM	G	
41370008	028699	TX 8	2,31	90	18	60	160	100	45	10
41370010	028712	TX 10	2,74	90	18	60	160	100	53	10
41370015	028729	TX 15	3,27	90	18	60	160	100	53	10
41370020	028736	TX 20	3,86	90	18	60	160	100	53	10
41370025	028743	TX 25	4,43	90	18	60	210	150	71	10
41370027	028750	TX 27	4,99	90	18	60	210	150	72	10
41370030	028774	TX 30	5,52	90	18	60	210	150	88	10
41370040	028781	TX 40	6,65	115	20	68	268	200	148	10
41370045	028798	TX 45	7,82	115	20	68	268	200	176	10
41370050	028804	TX 50	8,83	115	20	68	268	200	208	10

4142 T-HANDLE SCREWDRIVERS - HEX NUTSPINNER

DIN 3125

Material: Chrome-vanadium steel.

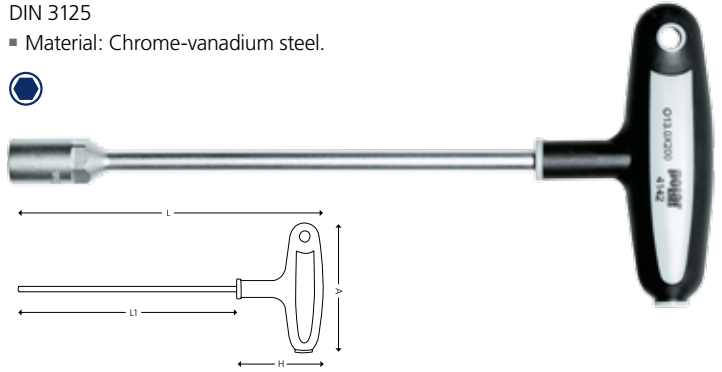

ITEM NO.	5704196+	SIZE MM	A MM	H MM	L MM	L1 MM	G	
41420005	028309	5	115	68	268	200	104	10
41420055	028316	5,5	115	68	268	200	106	10
41420006	028323	6	115	68	268	200	121	10
41420007	028330	7	115	68	268	200	119	10
41420008	028347	8	115	68	268	200	143	10
41420009	028354	9	115	68	268	200	146	10
41420010	028361	10	115	68	268	200	171	10
41420011	028387	11	115	68	268	200	178	10
41420012	028385	12	115	68	268	200	178	10
41420013	028392	13	115	68	268	200	182	10
41420014	028408	14	115	68	268	200	182	10
41420017	028415	17	115	68	268	200	208	10

4197 T-HANDLE SCREWDRIVER SET - TORX®

Supplied in practical holder.



ITEM NO.	5704196+	QTY.	SIZE MM	G	
41971008	028804	8	T10 - T15 - T20 - T25 - T30 - T40 - T45 - T50	1150	1





BITS AND -SETS

1/4" 1/4" BITS AND ACCESSORIES

4514 1/4" BITS FOR SLOTTED HEAD SCREWS

ISO 1173/2351, DIN 3126 C 6,3/3127

- Surface: Sandblasted and oiled. Material: Silicon chrome-vanadium steel.



ITEM NO.	5704196+	A X B MM	L MM	QTY. PCS.	G	
45140030	025872	0,5 x 3,0	25	1	4	1
45140035	007120	0,5 x 3,5	25	10	5	24
45140045	007137	0,6 x 4,5	25	10	5	24
45140050	025889	0,8 x 5,0	25	1	5	1
45140055	007144	1,0 x 5,5	25	10	5	24
45140065	007151	1,2 x 6,5	25	10	6	24
45140080	007168	1,6 x 8	25	10	6	24

4514 PH 1/4" BITS FOR PHILLIPS® SCREWS

ISO 1173/8764, DIN 3126 C 6,3/3128

- ACR profile for maximum bite into fasteners.
- Surface: Sandblasted and oiled. Material: Silicon chrome-vanadium steel.



ITEM NO.	5704196+	PH	L MM	QTY. PCS.	G	
45141000	025896	0	25	1	4	1
45141001	011363	1	25	10	5	24
45141002	011370	2	25	10	6	24
45141902	015958	2	25	50	6	1
45141003	011387	3	25	10	6	24
45141004	025902	4	25	1	7	1

4514 PH R 1/4" BITS FOR PHILLIPS® SCREWS

ISO 1173/8764, DIN 3126 C 6,3/3128

- ACR profile for maximum bite into fasteners.
- Slim model for drywall screws.
- Surface: Sandblasted and oiled. Material: Silicon chrome-vanadium steel.



ITEM NO.	5704196+	PH	L MM	QTY. PCS.	G	
45141502	007205	2	25	10	6	24

POLAR® SCREWDRIVERS AND BITS



4514 PZ 1/4" BITS FOR POZIDRIV® SCREWS

ISO 1173/8764, DIN 3126 C 6,3

- ACR profile for maximum bite into fasteners.
- Surface: Sandblasted and oiled. Material: Silicon chrome-vanadium steel.



ITEM NO.	5704196+	PZ	L MM	QTY. PCS.	G	
45142000	025919	0	25	1	4	1
45142001	011264	1	25	10	5	24
45142002	011301	2	25	10	6	24
45142902	015965	2	25	50	6	1
45142003	011318	3	25	10	6	24
45142004	025902	4	25	1	7	1

4514 STX 1/4" BITS FOR TAMPER RESISTANT® TORX® HEAD SCREWS

ISO 1173, DIN 3126 C 6,3

- Surface: Sandblasted and oiled. Material: Silicon chrome-vanadium steel.



ITEM NO.	5704196+	TORX® NO.	MM	L MM	QTY. PCS.	G	
45144006	025933	T6	1,70	25	1	4	1
45144007	025940	T7	1,99	25	1	4	1
45144008	025597	T8	2,31	25	1	5	1
45144009	007359	T9	2,50	25	10	5	24
45144010	007366	T10	2,74	25	10	5	24
45144015	007373	T15	3,27	25	10	5	24
45144020	007380	T20	3,86	25	10	5	24
45144025	007397	T25	4,43	25	10	5	24
45144027	007403	T27	4,99	25	10	6	24
45144030	007410	T30	5,52	25	10	6	24
45144040	007427	T40	6,65	25	10	6	24
45144045	013732	T45	7,82	25	10	7	24
45144050	013749	T50	8,83	25	10	7	24

4514 TX 1/4" BITS FOR TORX® HEAD SCREWS

ISO 1173, DIN 3126 C 6,3

- Surface: Sandblasted and oiled. Material: Silicon chrome-vanadium steel.



ITEM NO.	5704196+	TORX® NO.	MM	L MM	QTY. PCS.	G	
45144105	025773	T5	1,40	25	1	4	1
45144106	025780	T6	1,70	25	1	4	1
45144107	025797	T7	1,99	25	1	4	1
45144108	025803	T8	2,31	25	1	5	1
45144109	015781	T9	2,50	25	10	5	24
45144110	015798	T10	2,74	25	10	5	24
45144910	015897	T10	2,74	25	50	5	1
45144115	015804	T15	3,27	25	10	5	24
45144915	015903	T15	3,27	25	50	5	1
45144120	015811	T20	3,86	25	10	5	24
45144920	015910	T20	3,86	25	50	5	1
45144125	015828	T25	4,43	25	10	5	24
45144925	015927	T25	4,43	25	50	5	1
45144127	015835	T27	4,99	25	10	6	24
45144927	015934	T27	4,99	25	50	6	1
45144130	015842	T30	5,52	25	10	6	24
45144930	015941	T30	5,52	25	50	6	1
45144140	015859	T40	6,65	25	10	6	24
45144145	015866	T45	7,82	25	10	7	24
45144150	015873	T50	8,83	25	10	7	24

4514 H 1/4" BITS FOR HEX HEAD SCREWS

ISO 1173/3109, DIN 3126 C 6,3/7426

- Surface: Sandblasted and oiled. Material: Silicon chrome-vanadium steel.



ITEM NO.	5704196+	SIZE MM	L MM	QTY. PCS.	G	
45145015	025964	1,5	25	1	4	1
45145020	007250	2	25	10	5	24
45145025	025971	2,5	25	1	5	1
45145030	007274	3	25	10	5	24
45145040	007281	4	25	10	5	24
45145050	007298	5	25	10	6	24
45145055	025988	5,5	25	1	6	1
45145060	007304	6	25	10	6	24
45145070	011011	7	25	10	6	24
45145080	007311	8	25	10	8	24

4514 HB 1/4" BITS FOR HEX HEAD BORE HOLE SCREWS

ISO 1173, DIN 3126 C 6,3

- Surface: Sandblasted and oiled. Material: Silicon chrome-vanadium steel.



ITEM NO.	5704196+	SIZE MM	L MM	QTY. PCS.	G	
45145115	025995	1,5	25	1	4	1
45145120	026008	2	25	1	5	1
45145125	026015	2,5	25	1	5	1
45145130	026022	3	25	1	5	1
45145140	026039	4	25	1	5	1
45145150	026046	5	25	1	6	1
45145155	026053	5,5	25	1	6	1
45145160	026060	6	25	1	6	1
45145170	026077	7	25	1	7	1
45145180	026084	8	25	1	7	1

POLAR® SCREWDRIVERS AND BITS



4514 HBI 1/4" BITS FOR HEX HEAD BORE HOLE SCREWS - INCH

ISO 1173, DIN 3126 C 6,3

■ Surface: Sandblasted and oiled. Material: Silicon chrome-vanadium steel.



ITEM NO.	5704196+	SIZE "	L MM	QTY. PCS.	G	
45145225	026091	5/64"	25	1	4	1
45145203	026107	3/32"	25	1	5	1
45145235	026114	7/64"	25	1	5	1
45145204	026161	1/8"	25	1	5	1
45145245	026138	9/64"	25	1	6	1
45145205	026145	5/32"	25	1	6	1

4514 TS 1/4" BITS FOR TORQ-SET® SCREWS

ISO 1173, DIN 3126 C 6,3

■ Surface: Sandblasted and oiled. Material: Silicon chrome-vanadium steel.



ITEM NO.	5704196+	SIZE	L MM	QTY. PCS.	G	
45147304	026206	4 mm	25	1	4	1
45147306	026213	6 mm	25	1	5	1
45147308	026220	8 mm	25	1	6	1
45147310	026237	10 mm	25	1	7	1
45147314	026244	1/4"	25	1	5	1

4514 HOOK 1/4" BITS FOR HOOKS

ISO 1173, DIN 3126 C 6,3

■ Surface: Sandblasted and oiled. Material: Silicon chrome-vanadium steel.



ITEM NO.	5704196+	L MM	QTY. PCS.	G	
45147000	025810	25	1	8	1

4514 XZN 1/4" BITS FOR XZN SCREWS

ISO 1173, DIN 3126 C 6,3

■ Surface: Sandblasted and oiled. Material: Silicon chrome-vanadium steel.



ITEM NO.	5704196+	SIZE	L MM	QTY. PCS.	G	
45147404	026251	XZN M4	25	1	4	1
45147405	026268	XZN M5	25	1	5	1
45147406	026275	XZN M6	25	1	5	1
45147408	026282	XZN M8	25	1	6	1

4514 SQ 1/4" BITS FOR SQUARE HEAD SCREWS

ISO 1173, DIN 3126 C 6,3

■ Surface: Sandblasted and oiled. Material: Silicon chrome-vanadium steel.



ITEM NO.	5704196+	TYPE	SIZE MM	L MM	QTY. PCS.	G	
45147100	025827	0	1,9	25	1	2	1
45147101	025834	1	2,4	25	1	2	1
45147102	025841	2	2,9	25	1	2	1
45147103	025858	3	3,4	25	1	2	1
45147104	025865	4	4,9	25	1	3	1

4514 TW 1/4" BITS FOR TRI-WING® SCREWS

ISO 1173, DIN 3126 C 6,3

■ Surface: Sandblasted and oiled. Material: Silicon chrome-vanadium steel.



ITEM NO.	5704196+	TYPE	L MM	QTY. PCS.	G	
45147501	026299	1	25	1	4	1
45147502	026305	2	25	1	5	1
45147503	026312	3	25	1	5	1
45147504	026329	4	25	1	6	1
45147506	026336	5	25	1	6	1

4514 SN 1/4" BITS FOR SPANNER SCREWS

ISO 1173, DIN 3126 C 6,3

■ Surface: Sandblasted and oiled. Material: Silicon chrome-vanadium steel.



ITEM NO.	5704196+	TYPE	L MM	QTY. PCS.	G	
45147204	026152	SN 4	25	1	4	1
45147206	026169	SN 6	25	1	5	1
45147208	026176	SN 8	25	1	6	1
45147210	026183	SN 10	25	1	6	1
45147212	026190	SN 12	25	1	6	1

4514 CG 1/4" BITS FOR CLUTCH G SCREWS

ISO 1173, DIN 3126 C 6,3

■ Surface: Sandblasted and oiled. Material: Silicon chrome-vanadium steel.



ITEM NO.	5704196+	TYPE	L MM	QTY. PCS.	G	
45147601	026343	1	25	1	4	1
45147602	026350	2	25	1	5	1
45147603	026367	3	25	1	6	1

POLAR® SCREWDRIVERS AND BITS



4590 H 1/4" BITS SET

ITEM NO. 45900015

- Bits set supplied in compact plastic box with 14 pcs. 1/4" color ring bits and magnetic bits holder.
- 15 tools.



CONTENT:

QTY.	DESCRIPTION	SIZE
2	Bits for Phillips® screws	4514 1/4" C PH 1 - 2
2	Bits for Pozidriv® screws	4514 1/4" C PZ 1 - 2
2	Bits for slotted head screws	4514 1/4" C 4 - 6 mm
3	Bits for hex head screws	4514 1/4" C H 3 - 4 - 5 mm
5	Bits for Torx® screws	4514 1/4" C TX T10 - T15 - T20 - T25 - T30 mm
1	Magnetic bits holder	4714 QR 65 mm

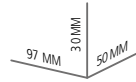

146 G

5704196 032603



15 TOOLS

4590 I 1/4" BITS SET

ITEM NO. 45900071

- Bits set supplied in compact plastic box with 69 pcs. 1/4" color ring bits, magnetic screwdriver bit socket and Quick-Release screwdriver bit socket.
- 71 tools.



CONTENT:

QTY.	DESCRIPTION	SIZE
12	Bits for Phillips® screws	4514 1/4" C PH 1 (3 pcs.) - PH 2 (6 pcs.) - PH 3 (3 pcs.)
12	Bits for Pozidriv® screws	4514 1/4" C PZ 1 (3 pcs.) - PZ 2 (6 pcs.) - PZ 3 (3 pcs.)
6	Bits for slotted head screws	4514 1/4" C 4 mm (3 pcs.) - 6 mm (3 pcs.)
9	Bits for hex head screws	4514 1/4" C H 4 mm (3 pcs.) - 5 mm (3 pcs.) - 6 mm (3 pcs.)
21	Bits for Torx® screws	4514 1/4" C TX T10 (3 pcs.) - T15 (3 pcs.) - T20 (3 pcs.) - T25 (3 pcs.) - T27 (3 pcs.) - T30 (3 pcs.) - T40 (3 pcs.)
3	Long bits for Phillips® screws	4514 1/4" C PH 1 - PH 2 - PH 3
2	Long bits for Pozidriv® screws	4514 1/4" C PZ 1 - PH 2
2	Long bits for slotted head screws	4514 1/4" C 4 mm - 6 mm
2	Long bits for Torx® screws	4514 1/4" C TX T20 - T25
1	Magnetic screwdriver bit socket	4714 M 1/4" 60 mm
1	Quick-Release screwdriver bit socket	4714 QR 50 mm

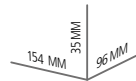

676 G

5704196 032580



71 TOOLS

4590 J 1/4" BITS SET

ITEM NO. 45900086

- Bits set supplied in compact plastic box with 84 pcs. 1/4" bits, magnetic screwdriver bit socket and Quick-Release screwdriver bit socket.
- 86 tools.



CONTENT:

QTY.	DESCRIPTION	SIZE
21	Bits for Phillips® screws	4514 1/4" PH 1 (7 pcs.) - PH 2 (7 pcs.) - PH 3 (7 pcs.)
14	Bits for Pozidriv® screws	4514 1/4" PZ 1 (7 pcs.) - PZ 2 (7 pcs.)
7	Bits for slotted head screws	4514 1/4" 4 mm (4 pcs.) - 6 mm (3 pcs.)
21	Bits for hex head screws	4514 1/4" H 4 mm (7 pcs.) - 7 mm (3 pcs.) - 7 mm (3 pcs.)
14	Bits for Torx® screws	4514 1/4" TX T10 (2 pcs.) - T15 (2 pcs.) - T20 (2 pcs.) - T25 (2 pcs.) - T27 (2 pcs.) - T30 (2 pcs.) - T40 (2 pcs.)
7	Bits for Tamper Resistant Torx® screws	4514 1/4" TTX T10 - T15 - T20 - T25 - T27 - T30 - T40
1	Magnetic screwdriver bit socket	4714 M 1/4" 60 mm
1	Quick-Release screwdriver bit socket	4714 QR 1/4" 50 mm

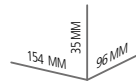

644 G

5704196 032498



86 TOOLS

POLAR® SCREWDRIVERS AND BITS



4590 EC 1/4" BITS SET

ITEM NO. 45900024

- Bits set supplied in compact plastic box with 17 pcs. 1/4" bits, 5 pcs. 1/4" magnetic nut setters,
- Quick-Release screwdriver bit socket and accessories.
- 24 tools.



CONTENT:

QTY.	DESCRIPTION	SIZE
3	Bits for Phillips® screws	4514 1/4" PH 1 - 2 - 3
1	Bits for Phillips® drywall screws	4514 1/4" PHD 2
1	Bits with reduced head for Phillips® screws	4514 1/4" PHR 2
3	Bits for Pozidriv® screws	4514 1/4" PZ 1 - 2 - 3
6	Bits for Torx® screws	4514 1/4" TX T10 - T15 - T20 - T25 - T30 - T40
3	Bits for square head screws	4514 1/4" SQ 1 - 2 - 3
1	Socket adaptor	4714 1/4 SQ 25 mm
5	Magnetic nut setters	4814 1/4" 8 - 10 - 11 - 13 mm / 1/4"
1	Quick-Release screwdriver bit socket	4714 1/4" QR

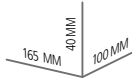

0,47 KG

5704196 014883



24
TOOLS



4590 A 1/4" BITS SET

ITEM NO. 45900032

- Bits set supplied in plastic box with 30 pcs. 1/4" bits, screwdriver bit socket and Quick-Release screwdriver bit socket.
- 32 tools.



CONTENT:

QTY.	DESCRIPTION	SIZE
1	Screwdriver bit socket	4714 1/4"
1	Quick-Release screwdriver bit socket	4714 1/4" QR
5	Bits for slotted head screws	4514 1/4" 3.5 - 4.5 - 5.5 - 6.5 - 8 mm
3	Bits for Phillips® screws	4514 1/4" PH 1 - 2 - 3
3	Bits for Pozidriv® screws	4514 1/4" PZ 1 - 2 - 3
10	Bits for Torx® head screws	4514 1/4" TX T7 - T8 - T9 - T10 - T15 - T20 - T25 - T27 - T30 - T40
7	Bits for hex head screws	4514 1/4" H 2 - 3 - 4 - 5 - 6 - 7 - 8 mm
2	Bits for square head screws	4514 1/4" SQ 1-2

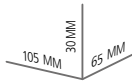

0,25 KG

5704196 000848



32
TOOLS



4590 E 1/4" BITS SET

ITEM NO. 45901032

- Bits set supplied in plastic box with 30 pcs. 1/4" bits, screwdriver bit socket and Quick-Release screwdriver bit socket.
- 32 tools.



CONTENT:

QTY.	DESCRIPTION	SIZE
1	Screwdriver bit socket	4714 1/4"
1	Quick-Release screwdriver bit socket	4714 1/4" QR
3	Bits for Phillips® screws	4514 1/4" PH 2
6	Bits for Pozidriv® screws	4514 1/4" PZ 2
6	Bits for Torx® head screws	4514 1/4" TX T15
6	Bits for Torx® head screws	4514 1/4" TX T20
6	Bits for Torx® head screws	4514 1/4" TX T25
3	Bits for Torx® head screws	4514 1/4" TX T30

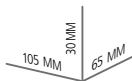

0,25 KG

5704196 017136



32
TOOLS



POLAR® SCREWDRIVERS AND BITS



4590 B 1/4" BITS SET

ITEM NO. 45900056

- Bits set in metal box with 52 pcs. 1/4" bits, magnetic bit holding screwdriver and accessories.
- 56 tools.

CONTENT:

QTY.	DESCRIPTION	SIZE
1	Magnetic bit holding screwdriver	4043 1/4" M
1	Quick-Release screwdriver bit socket	4714 1/4" QR
1	Screwdriver bit socket	4714 1/4"
1	Socket adaptor	4714 1/4" SQ 25 mm
5	Bits for slotted head screws	4514 1/4" 3.5 - 4.5 - 5.5 - 6.5 - 8 mm
3	Bits for Phillips® screws	4514 1/4" ACR PH 1 - 2 - 3
3	Bits for Pozidriv® screws	4514 1/4" ACR PZ 1 - 2 - 3
7	Bits for Torx® screws	4514 1/4" TX T10 - T15 - T20 - T25 - T27 - T30 - T40
9	Bits for Tamper Resistant® Torx® head screws	4514 1/4" STX T8 - T9 - T10 - T15 - T20 - T25 - T27 - T30 - T40
7	Bits for hex head bore hole screws	4514 1/4" HB 2 - 2,5 - 3 - 4 - 5 - 6 - 8 mm
1	Bits for square head screws	4514 1/4" SQ 2
5	Bits for Spanner screws	4514 1/4" SN 4 - 6 - 8 - 10 - 12
4	Bits for Torq-Set® screws	4514 1/4" TS 6 - 8 - 10 mm / 1/4"
3	Bits for XZN screws	4514 1/4" XZN 5 - 6 - 8
4	Bits for Tri-Wing® screws	4514 1/4" TW 2 - 3 - 4 - 5
1	Bits for hooks	4514 1/4" HOOK

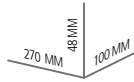

1,06 KG

5704196 000855

1

**56
TOOLS**



4590 C 1/4" BITS SET

ITEM NO. 45900109

- Bits set in metal box with 103 pcs. 1/4" bits, magnetic bit holding screwdriver and accessories.
- 109 tools.

CONTENT:

QTY.	DESCRIPTION	SIZE
1	Magnetic bit holding screwdriver	4043 1/4" M
1	Magnetic screwdriver bit socket	4714 1/4" M
1	Screwdriver bit socket	4714 1/4"
1	Flexible extension with Quick-Release screwdriver bit socket	4714 1/4" QRF
1	Socket adaptor	4714 1/4" SQ 25 mm
1	Socket adaptor	4714 1/4" SQ 50 mm
6	Bits for slotted head screws	4514 1/4" 3 - 3.5 - 4.5 - 5 - 5.5 - 6.5 mm
5	Bits for Phillips® screws	4514 1/4" PH 0 - 1 - 2 - 3 - 4
3	Bits for Phillips® screws	4514 1/4" ACR PH 1 - 2 - 3
1	Bits with reduced head for Phillips® screws	4514 1/4" PHR 2
5	Bits for Pozidriv® screws	4514 1/4" PZ 0 - 1 - 2 - 3 - 4
3	Bits for Pozidriv® screws	4514 1/4" ACR PZ 1 - 2 - 3
15	Bits for Torx® screws	4514 1/4" TX T5 - T6 - T7 - T8 - T9 - T10 - T15 - T20 - T25 - T27 - T30 - T40 - T45 - T50
11	Bits for Tamper Resistant® Torx® head screws	4514 1/4" STX T6 - T7 - T8 - T9 - T10 - T15 - T20 - T25 - T27 - T30 - T40
10	Bits for hex head screws	4514 1/4" H 1.5 - 2 - 2.5 - 3 - 4 - 5 - 5.5 - 6 - 7 - 8 mm
10	Bits for hex head bore hole screws	4514 1/4" HB 1.5 - 2 - 2.5 - 3 - 4 - 5 - 5.5 - 6 - 7 - 8 mm
6	Bits for hex head bore hole screws	4514 1/4" HB 5/64 - 3/32 - 7/64 - 1/8 - 9/64 - 5/32"
5	Bits for square head screws	4514 1/4" SQ 0 - 1 - 2 - 3 - 4
5	Bits for Spanner screws	4514 1/4" SN 4 - 6 - 8 - 10 - 12
5	Bits for Torq-Set® screws	4514 1/4" TS 4 - 6 - 8 - 10 mm / 1/4"
4	Bits for XZN screws	4514 1/4" XZN 4 - 5 - 6 - 8
5	Bits for Tri-Wing® screws	4514 1/4" TW 1 - 2 - 3 - 4 - 5
3	Bits for Clutch G screws	4514 1/4" CG 1 - 2 - 3
1	Bits for hooks	4514 1/4" HOOK

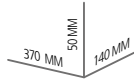

2,15 KG

5704196 000862

1

**109
TOOLS**



POLAR® SCREWDRIVERS AND BITS



4590 F 1/4", 3/8" AND 1/2" TORX® SET

ITEM NO. 45900035

- Bits and socket wrench set supplied in metal box with Torx® sockets, short and long Torx® bits and accessories.
- 35 tools.

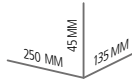

1,9 KG

5704196 017112



CONTENT:

QTY.	DESCRIPTION	SIZE
4	Bits for Tamper Resistant® Torx® screws	4514 1/4" STX T9 - T10 - T15 - T20
6	Bits for Tamper Resistant® Torx® screws	4520 10 mm STX T25 - T27 - T30 - T40 - T45 - T50
7	Long bits for Torx® skruer, 75 mm	4520 10 mm TX T25 - T27 - T30 - T40 - T45 - T50 - T55
2	Long bits for Torx® skruer, 75 mm	4524 14 mm TX T60 - T70
5	Sockets for Torx® screws	5014 1/4" NTX E4 - E5 - E6 - E7 - E8
7	Sockets for Torx® screws	5038 3/8" NTX E10 - E11 - E12 - E14 - E16 - E18 - E20
1	Screwdriver bit socket	4714 1/4" x 1/4"
1	Screwdriver bit socket	4738 3/8" x 10 mm
2	Screwdriver bit sockets	4712 1/2" x 10 mm - 1/2" x 14 mm

4590 G 1/4" BITS SET

ITEM NO. 45900021

- Bits set supplied in plastic box with 20 pcs. 1/4" bits and Quick-Release screwdriver bit socket.
- 21 tools.

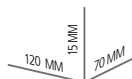

170 G

5704196 018690



CONTENT:

QTY.	DESCRIPTION	SIZE
1	Quick-Release screwdriver bit socket	4714 1/4" QR
1	Bits for slotted head screws	4514 1/4" 4 mm
1	Bits for slotted head screws	4514 1/4" 5.5 mm
1	Bits for Phillips® screws	4514 1/4" PH 1
3	Bits for Phillips® screws	4514 1/4" PH 2
1	Bits for Phillips® screws	4514 1/4" PH 3
1	Bits for Pozidriv® screws	4514 1/4" PZ 1
3	Bits for Pozidriv® screws	4514 1/4" PZ 2
1	Bits for Pozidriv® screws	4514 1/4" PZ 3
2	Bits for Torx® head screws	4514 1/4" TX T15
2	Bits for Torx® head screws	4514 1/4" TX T20
2	Bits for Torx® head screws	4514 1/4" TX T25
1	Bits for Torx® head screws	4514 1/4" TX T27
1	Bits for Torx® head screws	4514 1/4" TX T30



POLAR® SCREWDRIVERS AND BITS



4614 1/4" BITS FOR SLOTTED HEAD SCREWS

ISO 1173/2351, DIN 3126 E 6,3/3127

- Surface: Sandblasted and oiled. Material: Silicon chrome-vanadium steel.



ITEM NO.	5704196+	A X B MM	L MM	QTY. PCS.	G	
46140030	011486	0,5 x 3,0	90	10	10	15
46140040	011493	0,5 x 4,0	90	10	12	15
46140050	011509	0,8 x 5,0	90	10	15	15
46140060	011516	1,0 x 6,0	90	10	19	15
46140070	011523	1,2 x 7,0	90	10	22	15
46140080	011530	1,2 x 8,0	90	10	30	12
46140100	011547	1,6 x 10,0	90	10	37	12

4614 STX 1/4" BITS FOR TAMPER RESISTANT® TORX® SCREWS

ISO 1173, DIN 3126 E 6,3

- Surface: Sandblasted and oiled. Material: Silicon chrome-vanadium steel.



ITEM NO.	5704196+	TORX® NO.	MM	L MM	QTY. PCS.	G	
46144010	011554	T10	2,72	90	10	12	15
46144015	011561	T15	3,26	90	10	13	15
46144020	011578	T20	3,86	90	10	15	15
46144025	011585	T25	4,43	90	10	19	15
46144027	011592	T27	4,99	90	10	21	15
46144030	011608	T30	5,52	90	10	22	15
46144040	011615	T40	6,65	90	10	24	15

4614 PH 1/4" BITS FOR PHILLIPS® SCREWS

ISO 1173/8764, DIN 3126 E 6,3/3128

- ACR profile for maximum bite into fasteners.
- Surface: Sandblasted and oiled. Material: Silicon chrome-vanadium steel.



ITEM NO.	5704196+	PH	L MM	QTY. PCS.	G	
46141001	011448	1	90	10	14	15
46141002	011219	2	90	10	17	15
46141003	011455	3	90	10	20	15

4714 QR 1/4" QUICK-RELEASE SCREWDRIVER BIT SOCKET

- Magnetic model with quick-release and locking pin.
- Surface: Chrome plated finish with burnished ring. Material: Chrome-vanadium steel.



ITEM NO.	5704196+		A MM	L MM	G	
47142014	015408	1/4"	11,5	50	25	20

4614 PZ 1/4" BITS FOR POZIDRIV® SCREWS

ISO 1173/8764, DIN 3126 E 6,3

- ACR profile for maximum bite into fasteners.
- Surface: Sandblasted and oiled. Material: Silicon chrome-vanadium steel.



ITEM NO.	5704196+	PZ	L MM	QTY. PCS.	G	
46142001	011462	1	90	10	14	15
46142002	011226	2	90	10	17	15
46142003	011479	3	90	10	20	15

4714 QRF 1/4" FLEXIBLE EXTENSION WITH QUICK-RELEASE SCREWDRIVER BIT SOCKET

- Maximum torque allowed: 2,8 Nm.
- Surface: Chrome plated finish with burnished ring. Material: Chrome-vanadium steel.



ITEM NO.	5704196+		A MM	L MM	G	
47142114	019031	1/4"	14	175	80	10

POLAR® SCREWDRIVERS AND BITS



4714 M 1/4" MAGNETIC SCREWDRIVER BIT SOCKET

- Surface: Chrome plated finish with burnished ring.
- Material: Chrome-vanadium steel.



ITEM NO.	5704196+	Ø	A MM	L MM	G	Box
47143014	015415	1/4"	10	60	23	20

4714 MC 1/4" MAGNETIC SCREWDRIVER BIT SOCKET WITH C-RING

- Surface: Chrome plated finish with burnished ring.
- Material: Chrome-vanadium steel.



ITEM NO.	5704196+	Ø	A MM	L MM	G	Box
47143114	015422	1/4"	10	60	24	20

4714 SQ 1/4" SOCKET WRENCH ADAPTORS

- Model with retaining ball.
- Surface: Sandblasted and oiled. Material: Silicon chrome-vanadium steel.



ITEM NO.	5704196+	Ø	Hex	L MM	G	Box
47144014	015439	1/4"	1/4"	25	7	30
47144114	015446	1/4"	1/4"	50	14	20
47144138	015453	3/8"	1/4"	50	20	20
47144112	015767	1/2"	1/4"	50	33	20

4814 1/4" MAGNETIC NUT SETTERS

- Surface: Sandblasted and oiled. Material: Silicon chrome-vanadium steel.



ITEM NO.	5704196+	Ø	Hex	L MM	G	Box
48145008	015729	8 mm	1/4"	65	31	20
48145010	015736	10 mm	1/4"	65	37	20
48145011	015743	11 mm	1/4"	65	42	20
48145013	015750	13 mm	1/4"	65	52	20
48145014	018591	1/4"	1/4"	65	30	20

5/16" 5/16" BITS AND ACCESSORIES

4516 5/16" BITS FOR SLOTTED HEAD SCREWS

ISO 1173/2351, DIN 3126 C 8/3127

- Surface: Sandblasted and oiled. Material: Silicon chrome-vanadium steel.



ITEM NO.	5704196+	A X B MM	L MM	QTY. PCS.	G	Box
45160080	013725	1,2 x 8	30	10	10	24
45160100	010984	1,6 x 10	30	5	18	24
45160120	010991	1,8 x 12	30	5	20	24

4516 PH 5/16" BITS FOR PHILLIPS® SCREWS

ISO 1173/8764, DIN 3126 C 8/3128

- ACR profile for maximum bite into fasteners.
- Surface: Sandblasted and oiled. Material: Silicon chrome-vanadium steel.



ITEM NO.	5704196+	PH	L MM	QTY. PCS.	G	Box
45161002	013657	2	30	10	9	24
45161003	013664	3	30	10	10	24
45161004	011394	4	30	10	16	24

4516 PZ 5/16" BITS FOR POZIDRIV® SCREWS

ISO 1173/8764, DIN 3126 C 8

- ACR profile for maximum bite into fasteners.
- Surface: Sandblasted and oiled. Material: Silicon chrome-vanadium steel.



ITEM NO.	5704196+	PZ	L MM	QTY. PCS.	G	Box
45162002	013756	2	30	10	9	24
45162003	013763	3	30	10	10	24
45162004	011325	4	30	10	16	24



POLAR® SCREWDRIVERS AND BITS



4516 TX 5/16" BITS FOR TORX® HEAD SCREWS

ISO 1173, DIN 3126 C 8

- Surface: Sandblasted and oiled. Material: Silicon chrome-vanadium steel.



ITEM NO.	5704196+	TORX® NO.	MM	L MM	QTY. PCS.	G	
45164010	028910	T10	2,74	30	1	8	1
45164015	028927	T15	3,27	30	1	8	1
45164020	028934	T20	3,86	30	1	9	1
45164025	028941	T25	4,43	30	1	10	1
45164030	028958	T30	5,52	30	1	11	1
45164040	010939	T40	6,65	30	10	12	24
45164045	010946	T45	7,82	30	10	13	24
45164050	010953	T50	8,83	30	10	14	24
45164055	010960	T55	11,22	30	5	20	24

4712 IB 1/2" IMPACT SCREWDRIVER BIT SOCKET

ISO 1173-1174, DIN 7427.

- For use with 5/16" screwdriver bits.
- Surface: Phosphatised finish. Material: Chrome-vanadium steel.

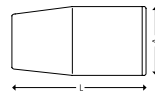

ITEM NO.	5704196+	5/16"	1/2"	A MM	L MM	G	
47126012	013701			22	38	63	1

4516 H 5/16" BITS FOR HEX HEAD SCREWS

ISO 1173/3109, DIN 3126 C 8/7426

- Surface: Sandblasted and oiled. Material: Silicon chrome-vanadium steel.



ITEM NO.	5704196+	SIZE MM	L MM	QTY. PCS.	G	
45165002	028873	2	30	1	8	1
45165025	028880	2,5	30	1	8	1
45165003	028897	3	30	1	9	1
45165004	028903	4	30	1	9	1
45165005	013671	5	30	10	10	24
45165006	013688	6	30	10	11	24
45165008	013695	8	30	10	13	24
45165010	010915	10	30	5	17	24
45165012	010922	12	30	5	22	24

4712 ID 1/2" IMPACT BIT DRIVER

- For fast and safe loosening of locked, rusted or glued screws.
- Torque: 400 Nm. Driving direction can be adjusted by turning the grip.
- Surface: Phosphatised. Material: Chrome-vanadium steel.

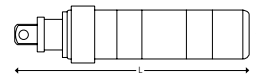

ITEM NO.	5704196+	1/2"	A MM	L MM	G	
47126112	013718		31	143	660	1

4790 1/2" IMPACT BIT DRIVER SET

ITEM NO. 47900015



- Set supplied in metal box with 5/16" bits (13 pcs.), bits socket and impact bit driver. 15 tools.

CONTENT:

QTY.	DESCRIPTION	SIZE
3	Bits for slotted head screws	4516 5/16" 8, 10, 12 mm
3	Bits for Phillips® screws	4516 5/16" ACR PH 2 - 3 - 4
4	Bits for Torx® screws	4516 5/16" TX T40 - T45 - T50 - T55
3	Bits for hex head screws	4516 5/16" H 5 - 6 - 8 mm
1	Screwdriver bit socket	4712 IB 1/2" x 5/16"
1	Impact bit driver	4712 1/2 ID

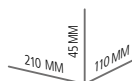

1,5 KG

5704196 013640

1

IMPA CODE 612432





POLAR® SOCKETS AND ACCESSORIES

SOCKETS & ACCESSORIES

POLAR® sockets and ratchets are designed to fit and built to perform for a lifetime.

Made from high grade chrome vanadium steel for a stronger and more durable tool.

- 1/4" Sockets, socket bits, ratchets and accessories
- 3/8" Sockets, ratchets and accessories
- 1/2" Sockets, socket bits, ratchets and accessories
- 3/4" Sockets, ratchets and accessories
- 1" Sockets, ratchets and accessories





POLAR® SOCKETS AND ACCESSORIES



6-Point



12-Point



Slotted



Phillips®



Pozidriv®



Torx®



Tamper resist Torx®



Torx®



Hexagon



Bit driver

POLAR® SOCKETS AND ACCESSORIES



1/4" SOCKETS AND ACCESSORIES

5014 1/4" 6-POINT METRIC SOCKETS

ISO 2725-1, DIN 3124

■ Surface: Satin chrome finish. Material: Chrome-vanadium steel.

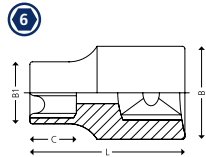

ITEM NO.	5704196+	SIZE MM	B MM	B1 MM	C MM	L MM	G	IMPA CODE
50140035	027999	3,5	11,9	6	5	25	10	10
50140004	000923	4	11,9	6,8	5	25	10	10
50140045	000930	4,5	11,9	7,1	5	25	10	610181
50140005	000947	5	11,9	8,0	5	25	10	610182
50140055	000954	5,5	11,9	8,3	5	25	10	610183
50140006	000961	6	11,9	9,3	5	25	11	610184
50140007	000978	7	11,9	10,5	5	25	12	610185
50140008	000985	8	11,9	11,9	5	25	12	610186
50140009	000992	9	13,0	13,0	8	25	12	610187
50140010	001005	10	14,0	14,0	8	25	22	610188
50140011	001012	11	15,9	15,9	8	25	24	610189
50140012	001029	12	16,9	16,9	8	25	27	610190
50140013	001036	13	17,8	17,8	10	25	31	610191
50140014	001043	14	19,6	19,6	10	25	38	10

5014 1/4" 6-POINT INCH SOCKETS

ANSI B107.1

■ Surface: Satin chrome finish. Material: Chrome-vanadium steel.

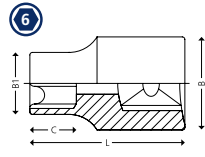

ITEM NO.	5704196+	SIZE "	B MM	B1 MM	C MM	L MM	G	IMPA CODE
50141005	001050	5/32"	11,9	6,8	5	25	10	10
50141006	001067	3/16"	11,9	8,0	5	25	10	610192
50141007	001074	7/32"	11,9	8,8	5	25	11	10
50141008	001081	1/4"	11,9	9,3	5	25	11	610193
50141009	001098	9/32"	11,9	10,5	5	25	12	610194
50141010	001104	5/16"	11,9	11,9	5	25	12	10
50141011	001111	11/32"	13,0	13,0	5	25	19	610195
50141012	001128	3/8"	14,0	14,0	8	25	22	610196
50141013	001135	13/32"	14,0	14,0	8	25	24	10
50141014	001142	7/16"	16,0	16,0	8	25	24	10
50141016	001159	1/2"	17,8	17,8	10	25	31	10

5014 L 1/4" 6-POINT LONG METRIC SOCKETS

ISO 2725-1, DIN 3124

■ Surface: Satin chrome finish. Material: Chrome-vanadium steel.

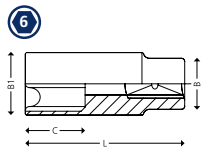

ITEM NO.	5704196+	SIZE MM	B MM	B1 MM	C MM	L MM	G	
50144004	001166	4	11,9	6,8	5	50	22	10
50144005	001173	5	11,9	8,0	5	50	21	10
50144055	001180	5,5	11,9	8,3	5	50	21	10
50144006	001197	6	11,9	9,3	8	50	22	10
50144007	001203	7	11,9	10,5	8	50	23	10
50144008	001210	8	11,9	11,9	8	50	25	10
50144009	001227	9	13,2	13,2	11	50	30	10
50144010	001234	10	14,6	14,6	11	50	40	10
50144011	001241	11	15,9	15,9	11	50	56	10
50144012	001258	12	17,0	17,0	13	50	53	10
50144013	001265	13	18,0	18,0	13	50	70	10

5014 NTX 1/4" SOCKETS FOR TORX® SCREWS

ANSI B107.1

■ Surface: Satin chrome finish. Material: Chrome-vanadium steel.

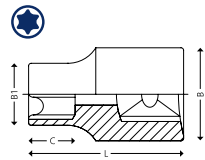

ITEM NO.	5704196+	TORX® NO	MM	B MM	B1 MM	C MM	L MM	G	
50146004	001494	E4	3,8	12,0	6,9	5	25	12	10
50146005	001500	E5	4,7	12,0	8,1	5	25	12	10
50146006	001517	E6	5,6	12,0	8,8	5	25	13	10
50146007	001524	E7	6,1	12,0	9,6	6	25	14	10
50146008	001531	E8	7,4	12,0	10,6	7	25	13	10
50146010	001548	E10	9,3	14,7	13,3	8	25	21	10



POLAR® SOCKETS AND ACCESSORIES



5114 1/4" SOCKET DRIVERS FOR SLOTTED HEAD SCREWS

ISO 2380, DIN 5264

■ Surface: Satin chrome finish. Material: Chrome-vanadium steel.

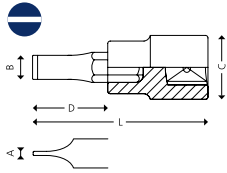

ITEM NO.	5704196+	A X B MM	C MM	D MM	L MM	G	
51143004	001272	0,6 x 4	18	11,9	37	14	10
51143007	001296	1,2 x 7	11,9	18	37	15	10
51143055	001289	08 x 5,5	11,9	18	37	14	10

5114 H 1/4" SOCKET DRIVERS FOR HEX HEAD SCREWS

DIN 7422

■ Surface: Satin chrome finish. Material: Chrome-vanadium steel.

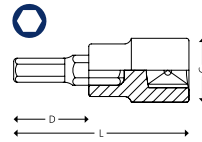

ITEM NO.	5704196+	SIZE MM	C MM	D MM	L MM	G	
51142003	001364	3	11,9	18	37	14	10
51142004	001371	4	11,9	18	37	14	10
51142045	019505	4,5	11,9	18	37	15	10
51142005	001388	5	11,9	18	37	15	10
51142055	019512	5,5	11,9	18	37	16	10
51142006	001395	6	11,9	18	37	16	10
51142007	001401	7	11,9	18	37	16	10
51142008	001418	8	11,9	18	37	17	10
51142010	030432	10	11,9	18	37	18	10

5114 PH 1/4" SOCKET DRIVERS FOR PHILLIPS® HEAD SCREWS

ISO 8764

■ Surface: Satin chrome finish. Material: Chrome-vanadium steel.

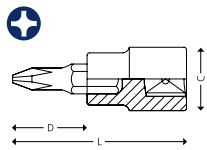

ITEM NO.	5704196+	PH	C MM	D MM	L MM	G	
51143101	001302	1	11,9	18	37	14	10
51143102	001319	2	11,9	18	37	14	10
51143103	001326	3	11,9	18	37	15	10

5114 STX 1/4" SOCKET DRIVERS FOR TAMPER RESIST® TORX® SCREWS

■ Surface: Satin chrome finish. Material: Chrome-vanadium steel.

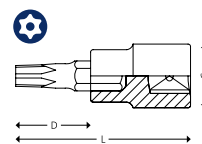

ITEM NO.	5704196+	TORX® NO	MM	C MM	D MM	L MM	G	
51141510	001425	T10	2,74	11,9	18	37	14	10
51141515	001432	T15	3,27	11,9	18	37	14	10
51141520	001449	T20	3,86	11,9	18	37	14	10
51141525	001456	T25	4,43	11,9	18	37	14	10
51141527	001463	T27	4,99	11,9	18	37	14	10
51141530	001470	T30	5,52	11,9	18	37	14	10
51141540	001487	T40	6,65	11,9	18	37	15	10

5114 PZ 1/4" SOCKET DRIVERS FOR POZIDRIV® HEAD SCREWS

ISO 8764

■ Surface: Satin chrome finish. Material: Chrome-vanadium steel.

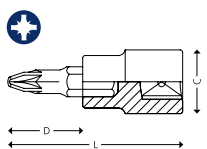

ITEM NO.	5704196+	PZ	C MM	D MM	L MM	G	
51143201	001333	1	11,9	18	37	14	10
51143202	001340	2	11,9	18	37	15	10
51143203	001357	3	11,9	18	37	15	10

4714 1/4" SCREWDRIVER BIT SOCKET

ISO 1173-1174, DIN 3126.

■ For use with 1/4" screwdriver bits.

■ Surface: Satin chrome finish. Material: Chrome-vanadium steel.

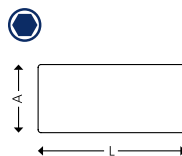

ITEM NO.	5704196+			A MM	L MM	G	
47145014	001555	1/4"	1/4"	12	25	14	10

POLAR® SOCKETS AND ACCESSORIES

5214 EX 1/4" EXTENSIONS

ISO 3316, DIN 3123.

- With ext. 11 mm hexagon.
- Surface: Satin chrome finish. Material: Chrome-vanadium steel.

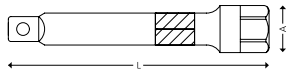

ITEM NO.	5704196+	L MM	A MM	G	IMPA CODE
52140050	001562	50	12	26	10 610448
52140100	001579	100	12	48	10
52140150	001586	150	12	70	10 610449

5614 A 1/4" ADAPTOR FROM 1/4" TO 3/8"

ISO 3316, DIN 3123

- Surface: Satin chrome finish. Material: Chrome-vanadium steel.

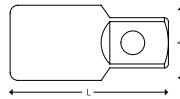

ITEM NO.	5704196+	1/4"	3/8"	A MM	L MM	G	IMPA CODE
56141438	001609	1/4"	3/8"	14	25,5	32	10 610471

5214 EX 1/4" EXTENSION WITH QUICK-RELEASE

ISO 3316, DIN 3123

- Surface: Satin chrome finish. Material: Chrome-vanadium steel.

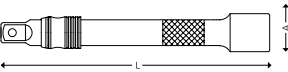

ITEM NO.	5704196+	L MM	A MM	G	IMPA CODE
52142250	027739	250	12,3	90	10

5414 TH 1/4" SLIDING T-HANDLE

ISO 3315, DIN 3122

- Surface: Satin chrome finish. Material: Chrome-vanadium steel.

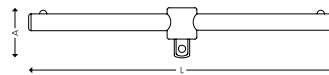

ITEM NO.	5704196+	L MM	A MM	G	IMPA CODE
54140014	001623	115	24	42	10 610421

5214 F 1/4" FLEXIBLE EXTENSION

- Maximum torque allowed: 2,8 Nm.
- Surface: Chrome plated finish. Material: Chrome-vanadium steel.

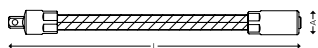

ITEM NO.	5704196+	L MM	A MM	G	IMPA CODE
52141150	001593	150	12	62	10

5814 U 1/4" UNIVERSAL JOINT

ISO 3316, DIN 3123

- Equipped with tension-spring. Joint stays at desired angle.
- Surface: Satin chrome finish. Material: Chrome-vanadium steel.

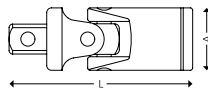

ITEM NO.	5704196+	L MM	A MM	G	IMPA CODE
58140014	001616	38	14	27	10 610465

POLAR® SOCKETS AND ACCESSORIES



5514 HD 1/4" PLASTIC HANDLE DRIVER

ISO 3315, DIN 3122

- Handle with internal 1/4" square drive.
- Surface: Satin chrome finish. Material: Chrome-vanadium steel.

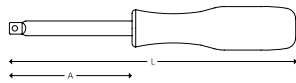

ITEM NO.	5704196+	L MM	A MM	G	IMPA CODE
55140014	001630	150	62	100	10 610446

5314 B 1/4" REVERSIBLE RATCHET W/ LOCKING SYSTEM

ISO 3315, DIN 3122

- Model with 48 teeth and Quick Release. Compact head with working angle of 7,5°.
- Surface: Satin chrome finish. Material: Chrome-vanadium steel.

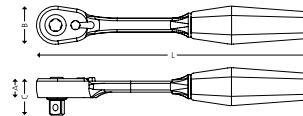

ITEM NO.	5704196+	A MM	B MM	C MM	L MM	G	IMPA CODE
53140048	015712	11,4	25	20	140	116	1 610401



5314 C 1/4" REVERSIBLE RATCHET W/ LOCKING SYSTEM

ISO 3315, DIN 3122

- Model with 72 teeth and Quick Release. Compact head with working angle of 5°.
- Surface: Satin chrome finish. Material: Chrome-vanadium steel.

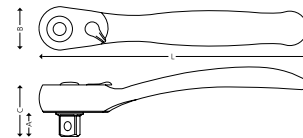

ITEM NO.	5704196+	A MM	B MM	C MM	L MM	G	IMPA CODE
53141072	020006	8,5	17,7	15,8	95	54	1

5314 E 1/4" REVERSIBLE RATCHET W/ LOCKING SYSTEM

ISO 3315, DIN 3122

- Model with 60 teeth and Quick Release. Compact head with working angle of 6°.
- Surface: Satin chrome finish. Material: Chrome-vanadium steel.

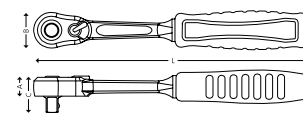

ITEM NO.	5704196+	A MM	B MM	C MM	L MM	G	IMPA CODE
53141060	027333	10	20	20	146	92	1

POLAR® SOCKETS AND ACCESSORIES



3/8" SOCKETS AND ACCESSORIES

5038 3/8" 6-POINT METRIC SOCKETS

ISO 2725-1, DIN 3124

■ Surface: Satin chrome finish. Material: Chrome-vanadium steel.

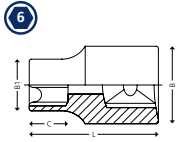

ITEM NO.	5704196+	SIZE MM	B MM	B1 MM	C MM	L MM	G	IMPA CODE
50380006	001654	6	17,0	10,2	8	28	22	610201
50380007	001661	7	17,0	10,6	8	28	22	610202
50380008	001678	8	17,0	11,8	8	28	24	610203
50380009	001685	9	17,0	13,2	8	28	24	610204
50380010	001692	10	17,0	14,5	8	28	25	610205
50380011	001708	11	17,0	15,7	8	28	24	610206
50380012	001715	12	16,0	17,0	8	28	23	610207
50380013	001722	13	16,5	18,0	8	28	27	610208
50380014	001739	14	17,0	19,6	12	28	34	610209
50380015	001746	15	18,0	20,9	12	28	41	610210
50380016	001753	16	19,0	22,0	12	30	43	610211
50380017	001760	17	20,0	23,4	12	30	54	610212
50380018	001777	18	21,0	24,6	12	30	60	610213
50380019	001784	19	23,0	26,0	14	30	68	610214
50380020	001791	20	24,0	27,1	14	32	81	610215
50380021	001807	21	25,0	28,0	14	32	83	610216
50380022	001814	22	26,0	29,6	14	32	99	610217
50380024	028835	24	28,0	32,0	17,5	32	107	610218

5038 3/8" 6-POINT INCH SOCKETS

ANSI B107.1

■ Surface: Satin chrome finish. Material: Chrome-vanadium steel.

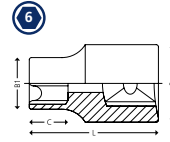

ITEM NO.	5704196+	SIZE "	B MM	B1 MM	C MM	L MM	G	IMPA CODE
50381008	001821	1/4"	17,0	10,2	8	28	22	610201
50381010	001838	5/16"	17,0	11,8	8	28	24	610202
50381012	001845	3/8"	17,0	14,5	8	28	25	610203
50381014	001852	7/16"	16,0	15,7	8	28	24	610204
50381016	001869	1/2"	17,0	18,0	8	28	27	610205
50381018	001883	9/16"	18,0	19,6	12	28	34	610206
50381019	001890	19/32"	19,0	21,8	12	30	41	610207
50381020	001906	5/8"	20,0	22,0	12	30	43	610208
50381022	001913	11/16"	23,0	23,4	12	30	54	610209
50381024	001920	3/4"	24,0	26,0	14	32	68	610210
50381026	001937	13/16"	26,0	28,0	14	32	83	610211
50381028	001944	7/8"	27,0	29,6	14	32	99	610212

5038 L 3/8" 6-POINT LONG METRIC SOCKETS

ISO 2725-1, DIN 3124

■ Surface: Satin chrome finish. Material: Chrome-vanadium steel.

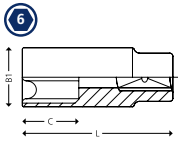

ITEM NO.	5704196+	SIZE MM	B MM	B1 MM	C MM	L MM	G	IMPA CODE
50384006	028842	6	17,0	10	18	63	50	610219
50384007	028859	7	17,0	10,5	14	63	50	610220
50384008	001951	8	17,0	11,8	9	63	51	610221
50384009	001968	9	17,0	13,2	9	63	53	610222
50384010	001975	10	17,0	14,5	9	63	56	610223
50384011	001982	11	17,0	15,7	12	63	62	610224
50384012	001999	12	16,0	17,0	12	63	70	610225
50384013	002002	13	16,5	18,0	12	63	76	610226
50384014	002019	14	17,0	19,6	15	63	86	610227
50384015	002026	15	18,0	20,9	15	63	111	610228
50384016	002033	16	19,0	22,0	15	63	101	610229
50384017	002040	17	20,0	23,4	15	63	122	610230
50384018	002057	18	21,0	24,6	18	63	153	610231
50384019	002064	19	23,0	26,0	18	63	142	610232
50384021	002071	21	25,0	28,0	18	63	160	610233
50384022	002088	22	26,0	29,6	21	63	195	610234

5192 L 3/8" LONG METRIC SOCKET WRENCH SET

ITEM NO. 51923814

■ Set in metal box with long 6-point sockets from 6 to 24 mm.
■ 14 tools.

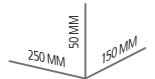

2,1 KG

5704196 029054

1

3/8"

14
TOOLS



CONTENT:

QTY.	DESCRIPTION	SIZE
14	Long 6-point sockets	5038 L 3/8" 6 - 8 - 10 - 11 - 12 - 13 - 14 - 16 - 17 - 18 - 19 - 21 - 22 - 24 mm

POLAR® SOCKETS AND ACCESSORIES



5038 NTX 3/8" SOCKETS FOR TORX® SCREWS

■ Surface: Satin chrome finish. Material: Chrome-vanadium steel.

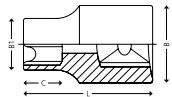

ITEM NO.	5704196+	TORX® NO.	MM	B MM	B1 MM	C MM	L MM	G	
50386006	028965	E6	5,6	17	9	5	28	25	10
50386007	028972	E7	6,1	17	10	6	28	26	10
50386008	028989	E8	7,4	17	11	9	28	27	10
50386010	028996	E10	9,3	17	13	10	28	28	10
50386012	029009	E12	11,1	17	15	10	28	27	10
50386014	029016	E14	12,8	17	18	10	28	34	10
50386016	029023	E16	14,7	17	20	10	28	43	10

5238 EX 3/8" EXTENSIONS WITH QUICK-RELEASE

ISO 3316, DIN 3123.

■ Surface: Satin chrome finish. Material: Chrome-vanadium steel.

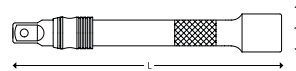

ITEM NO.	5704196+	L MM	A MM	G	
52382075	027746	75	15,5	68	10
52382125	027753	125	15,5	112	10
52382200	027760	200	15,5	184	10

5038 SP 3/8" SPARK PLUG SOCKETS

ISO 11168

- Rubber gasket for retaining the spark plug.
- Surface: Satin chrome finish. Material: Chrome-vanadium steel.

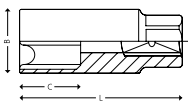

ITEM NO.	5704196+	SIZE MM	MM	B MM	L MM	G	
50380516	002095	16	19	22	63	91	10
50380518	015682	18	22	24,5	63	118	10
50380521	002101	21	22	27,5	63	127	10

5238 EX 3/8" EXTENSIONS

ISO 3316, DIN 3123.

- With ext. 16 mm Hexagon.
- Surface: Chrome plated finish. Material: Chrome-vanadium steel.

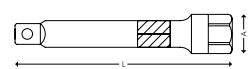

ITEM NO.	5704196+	L MM	A MM	G		IMPA CODE
52380075	002118	75	18	83	10	610450
52380150	002132	150	18	155	10	610451
52380250	002149	250	18	244	10	610452

5290 3/8" QUICK-RELEASE EXTENSION BAR SET

■ Supplied in nylon bag.



3
TOOLS

ITEM NO.	5704196+	QTY.	SIZE MM	G	
52903803	027807	3	75 mm, 125 mm, 200 mm	440	1

5238 EXW 3/8" WOBBLE EXTENSIONS

- Can be used for both wobble and rigid functionality.
- The wobble function provides 15° of additional accessibility.
- With ext. 16 mm Hexagon.
- Surface: Chrome plated finish. Material: Chrome-vanadium steel.

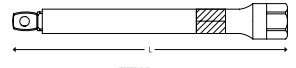

ITEM NO.	5704196+	L MM	A MM	G	
52381075	011028	75	18	83	10
52381150	011035	150	18	155	10
52381250	011042	250	18	244	10
52381450	011059	450	18	630	10

POLAR® SOCKETS AND ACCESSORIES

5438 TH 3/8" SLIDING T-HANDLE

ISO 3315, DIN 3122

- Surface: Satin chrome finish. Material: Chrome-vanadium steel.

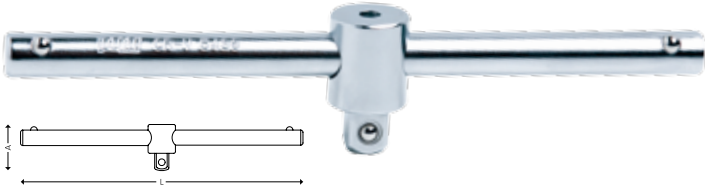

ITEM NO.	5704196+	L MM	A MM	G	IMPA CODE
54380038	002187	164	34	43	10 610422

5938 FH 3/8" SWIVEL HANDLE

ISO 3316, DIN 3123

- Surface: Chrome plated finish. Material: Chrome-vanadium steel.

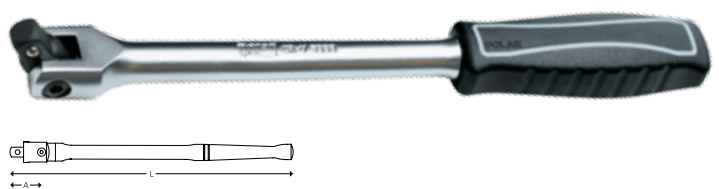

ITEM NO.	5704196+	L MM	A MM	G	IMPA CODE
59380250	028866	250	26,5	270	1 610422

5838 U 3/8" UNIVERSAL JOINT

ISO 3316, DIN 3123

- Equipped with tension-spring. Joint stays at desired angle.
- Surface: Satin chrome finish. Material: Chrome-vanadium steel.



ITEM NO.	5704196+	L MM	A MM	G	IMPA CODE
58380038	002170	56	20	67	10 610466

5338 E 3/8" REVERSIBLE RATCHET WITH LOCKING SYSTEM



ISO 3315, DIN 3122

- Model with 60 teeth and Quick Release.
- Compact head with working angle of 6°.
- Surface: Satin chrome finish. Material: Chrome-vanadium steel.



ITEM NO.	5704196+	A MM	B MM	C MM	L MM	G	IMPA CODE
53380060	027340	13	28	26	199	216	1

5738 A 3/8" ADAPTOR FROM 3/8" TO 1/4"

ISO 3316, DIN 3123

- Surface: Satin chrome finish. Material: Chrome-vanadium steel.



ITEM NO.	5704196+	□	■	A MM	L MM	G	IMPA CODE
57383814	002156	3/8"	1/4"	16	27	30	10 610472

5638 A 3/8" ADAPTOR FROM 3/8" TO 1/2"

ISO 3316, DIN 3123

- Surface: Satin chrome finish. Material: Chrome-vanadium steel.



ITEM NO.	5704196+	□	■	A MM	L MM	G	IMPA CODE
56383812	002163	3/8"	1/2"	16	37,5	69	10 610473



POLAR® SOCKETS AND ACCESSORIES



1/2" SOCKETS AND ACCESSORIES

5012 1/2" 6-POINT METRIC SOCKETS

ISO 2725-1, DIN 3124

■ Surface: Satin chrome finish. Material: Chrome-vanadium steel.

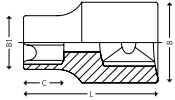

ITEM NO.	5704196+	SIZE MM	B MM	B1 MM	C MM	L MM	G	IMPA CODE
W 50120008	002200	8	21,8	13,2	12	38	47	10 610241
W 50120009	002217	9	21,8	13,9	12	38	47	10 610242
W 50120010	002224	10	21,8	15,0	12	38	49	10 610243
W 50120011	002231	11	21,8	16,3	12	38	50	10 610244
W 50120012	002248	12	21,8	17,6	12	38	50	10 610245
W 50120013	002255	13	21,8	18,8	12	38	51	10 610246
W 50120014	002262	14	21,8	20,4	12	38	53	10 610247
W 50120015	002279	15	20,7	21,6	12	38	54	10 610248
W 50120016	002286	16	21,5	22,9	12	38	61	10 610249
W 50120017	002293	17	22,0	24,0	12	38	68	10 610250
W 50120018	002309	18	23,0	25,4	12	38	85	10 610251
W 50120019	002316	19	23,0	26,0	14	38	73	10 610252
W 50120020	002323	20	24,0	27,9	14	38	86	10 610253
W 50120021	002330	21	25,0	28,0	14	38	82	10 610254
W 50120022	002347	22	26,0	30,0	14	40	106	10 610255
W 50120023	002354	23	27,0	31,6	14	40	125	10 610256
W 50120024	002361	24	28,0	32,0	16	42	121	10 610257
50120025	002378	25	30,0	34,0	16	42	150	10
50120026	002385	26	30,0	35,4	16	42	170	10 610258
W 50120027	002392	27	30,0	36,0	18	43	168	10 610259
50120028	002408	28	32,0	37,9	18	43	193	10 610260
50120029	002415	29	32,0	38,0	20	43	205	10 610261
W 50120030	002422	30	34,0	40,0	22	46	225	10 610262
W 50120032	002439	32	36,0	42,0	22	46	255	10 610263

5012 L 1/2" 6-POINT LONG METRIC SOCKETS

ISO 2725-1, DIN 3124

■ Surface: Satin chrome finish. Material: Chrome-vanadium steel.

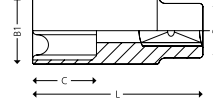

ITEM NO.	5704196+	SIZE MM	B MM	B1 MM	C MM	L MM	G	IMPA CODE
W 50124010	002835	10	22,0	15,0	12	77	96	10 610376
W 50124011	002842	11	22,0	16,3	12	77	101	10 610377
W 50124012	002859	12	22,0	17,6	12	77	107	10 610378
W 50124013	002866	13	22,0	18,8	12	77	109	10 610379
W 50124014	002873	14	22,0	20,4	15	77	112	10 610380
W 50124015	002880	15	20,7	21,6	15	77	109	10
W 50124016	002897	16	21,5	22,9	15	77	112	10
W 50124017	002903	17	22,0	24,0	15	77	133	10 610381
W 50124018	002910	18	23,0	25,4	18	77	179	10
W 50124019	002927	19	23,0	26,0	18	77	157	10 610382
W 50124020	002934	20	24,0	27,9	18	77	210	10
W 50124021	002941	21	25,0	28,0	18	77	222	10 610383
W 50124022	002958	22	26,0	30,0	21	77	227	10 610384
W 50124024	002965	24	28,0	32,0	24	77	255	10 610386

5192 L 1/2" LONG METRIC SOCKET WRENCH SET

ITEM NO. 51921210

- Set in metal box with long 6-point sockets from 10 to 19 mm.
- 10 tools.

1/2"

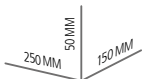

2 KG

5704196 029030

1

CONTENT:

QTY.	DESCRIPTION	SIZE
10	Long 6-point sockets	5012 1/2" L 10 - 11 - 12 - 13 - 14 - 15 - 16 - 17 - 18 - 19 mm



POLAR® SOCKETS AND ACCESSORIES



5192 L 1/2" LONG METRIC SOCKET WRENCH SET

- Set in metal box with long 6-point sockets from 10 to 24 mm.
- 12 tools.

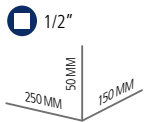

- 2 KG
- 5704196 029047
- 1



CONTENT:

QTY.	DESCRIPTION	SIZE
12	Long 6-point sockets	5012 1/2" L 10 - 11 - 12 - 13 - 14 - 16 - 17 - 18 - 19 - 21 - 22 - 24 mm

5012 B 1/2" 12-POINT METRIC SOCKETS

ISO 2725-1, DIN 3124

- Surface: Satin chrome finish. Material: Chrome-vanadium steel.

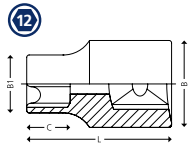

ITEM NO.	5704196+	SIZE MM	B MM	B1 MM	C MM	L MM	G G	IMPA CODE
W 50122010	002613	10	21,8	15,0	12	38	49	10 610268
W 50122011	002620	11	21,8	16,3	12	38	50	10 610269
W 50122012	002637	12	21,8	17,6	12	38	50	10 610270
W 50122013	002644	13	21,8	18,8	12	38	51	10 610271
W 50122014	002651	14	21,8	20,4	12	38	53	10 610272
W 50122015	002668	15	20,7	21,6	12	38	54	10 610274
W 50122016	002675	16	21,5	22,9	12	38	61	10 610275
W 50122017	002682	17	22,0	24,0	12	38	68	10 610276
W 50122018	002699	18	23,0	25,4	12	38	85	10 610278
W 50122019	002705	19	23,0	26,0	14	38	73	10 610279
W 50122020	002712	20	24,0	27,9	14	38	86	10 610280
W 50122021	002729	21	25,0	28,0	14	38	82	10 610281
W 50122022	002736	22	26,0	30,0	14	40	106	10 610282
W 50122023	002743	23	27,0	31,6	14	40	125	10 610283
W 50122024	002750	24	28,0	32,0	16	42	121	10 610284
W 50122025	002767	25	30,0	34,0	16	42	150	10
W 50122026	002774	26	30,0	35,4	16	42	170	10 610285
W 50122027	002781	27	30,0	36,0	18	43	168	10 610286
W 50122028	002798	28	32,0	37,9	18	43	193	10 610287
W 50122029	002804	29	32,0	38,0	20	43	205	10 610288
W 50122030	002811	30	34,0	40,0	22	46	225	10 610289
W 50122032	002828	32	36,0	42,0	22	46	255	10 610290



POLAR® SOCKETS AND ACCESSORIES



5012 1/2" 6-POINT INCH SOCKETS

ANSI B107.1

- Surface: Satin chrome finish. Material: Chrome-vanadium steel.

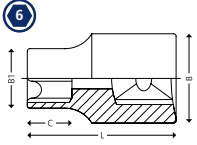

ITEM NO.	5704196+	SIZE "	B MM	B1 MM	C MM	L MM	G G	
50121012	002446	3/8"	21,8	15,0	12	38	49	10
50121014	002453	7/16"	21,8	16,3	12	38	50	10
50121016	002460	1/2"	21,8	18,8	12	38	51	10
50121018	002477	9/16"	21,8	20,4	12	38	53	10
50121019	002484	19/32"	20,7	21,6	12	38	54	10
50121020	002491	5/8"	21,5	22,9	12	38	61	10
50121022	002507	11/16"	22,0	24,0	12	38	68	10
50121024	002514	3/4"	23,0	26,0	14	38	73	10
50121025	002521	25/32"	24,0	27,9	14	38	86	10
50121026	002538	13/16"	25,0	28,0	14	38	82	10
50121028	002545	7/8"	26,0	30,0	14	40	106	10
50121030	002552	15/16"	28,0	32,0	16	42	121	10
50121032	002569	1"	30,0	34,0	16	42	150	10
50121034	002576	1 1/16"	30,0	36,0	18	43	168	10
50121036	002583	1 1/8"	32,0	38,0	20	43	205	10
50121038	002590	1 3/16"	34,0	40,0	22	46	225	10
50121040	002606	1 1/4"	36,0	42,0	22	46	225	10

5012 NTX 1/2" SOCKETS FOR TORX® SCREWS

- Surface: Satin chrome finish. Material: Chrome-vanadium steel.

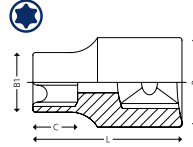

ITEM NO.	5704196+	TORX® NO.	MM	B MM	B1 MM	C MM	L MM	G G	
50126010	002972	E10	9,3	22,0	13,5	7	38	52	10
50126011	010793	E11	9,8	22,0	14,0	8	38	53	10
50126012	002989	E12	11,1	22,0	15,0	8	38	57	10
50126014	002996	E14	12,8	22,0	17,0	9	38	63	10
50126016	003009	E16	14,7	22,0	19,0	10	38	57	10
50126018	003016	E18	16,6	24,0	21,0	12	38	72	10
50126020	003023	E20	18,4	22,0	24,0	13	38	80	10
50126022	010809	E22	20,0	23,0	26,0	14	38	95	10
50126024	003030	E24	22,1	24,0	28,0	16	38	114	10



5090 NTX 1/2" SOCKET SET FOR TORX® SCREWS

ITEM NO. 50901207

- Set in metal box with Torx® sockets from E10 to E24.
- 7 tools.

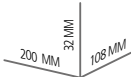

0,9 KG

5704196 000701

1

7
TOOLS



CONTENT:

QTY.	DESCRIPTION	SIZE
7	Sockets for Torx® screws	5112 1/2" NTX E10 - E12 - E14 - E16 - E18 - E20 - E24



POLAR® SOCKETS AND ACCESSORIES



5112 1/2" SOCKET DRIVERS FOR SLOTTED HEAD SCREWS

ISO 2380, DIN 5264

■ Surface: Satin chrome finish. Material: Chrome-vanadium steel.

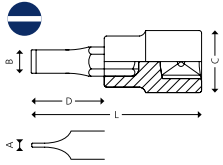

ITEM NO.	5704196+	A X B MM	C MM	D MM	L MM	G	
51123012	003306	1,2 x 8	23,9	24	62	53	10
51123016	003313	1,6 x 10	23,9	24	62	87	10
51123020	003320	2 x 12	23,9	24	62	98	10

5112 PZ 1/2" SOCKET DRIVERS FOR POZIDRIV® HEAD SCREWS

ISO 8764

■ Surface: Satin chrome finish. Material: Chrome-vanadium steel.

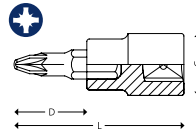

ITEM NO.	5704196+	PZ	C MM	D MM	L MM	G	
51123203	003382	3	23,9	24	62	89	10
51123204	010854	4	23,9	24	62	89	10

5112 PH 1/2" SOCKET DRIVERS FOR PHILLIPS® HEAD SCREWS

ISO 8764

■ Surface: Satin chrome finish. Material: Chrome-vanadium steel.

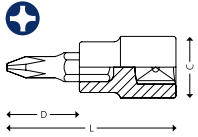

ITEM NO.	5704196+	PH	C MM	D MM	L MM	G	
51123103	003351	3	23,9	24	62	89	10
51123104	010847	4	23,9	24	62	89	10

5112 H 1/2" SOCKET DRIVERS FOR HEX HEAD SCREWS

DIN 7422

■ Surface: Satin chrome finish. Material: Chrome-vanadium steel.

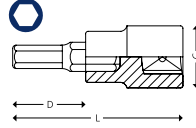

ITEM NO.	5704196+	SIZE MM	C MM	D MM	L MM	G	
51122005	003139	5	23,9	24	62	89	10
51122006	003146	6	23,9	24	62	89	10
51122007	003153	7	23,9	24	62	90	10
51122008	003160	8	23,9	24	62	91	10
51122009	019000	9	23,9	24	62	93	10
51122010	003184	10	23,9	24	62	95	10
51122012	003191	12	23,9	24	62	107	10
51122014	003207	14	23,9	24	62	121	10
51122017	003214	17	25,9	24	62	162	10
51122019	003221	19	25,9	24	62	170	10

5190 H 1/2" SOCKET DRIVER SET FOR HEX HEAD SCREWS

ITEM NO. 51901210

■ Set in metal box with socket drivers for hex head screws from 5 to 19 mm.

■ 10 tools.

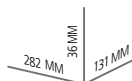

3,1 KG

5704196 000688

1

CONTENT:

QTY.	DESCRIPTION	SIZE
10	Socket drivers for hex head screws	5112 1/2" H 5 - 6 - 7 - 8 - 9 - 10 - 12 - 14 - 17 - 19 mm

10
TOOLS



POLAR® SOCKETS AND ACCESSORIES



5112 HI 1/2" INCH SOCKET DRIVERS FOR HEX HEAD SCREWS

DIN 7422

- Surface: Satin chrome finish. Material: Chrome-vanadium steel.

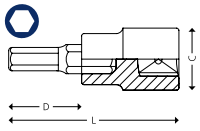

ITEM NO.	5704196+	SIZE	C	D	L	G	Icon
		"	MM	MM	MM		
51122206	029061	3/16"	23,9	24	62	85	10
51122207	029078	7/32"	23,9	24	62	86	10
51122208	029085	1/4"	23,9	24	62	86	10
51122210	029092	5/16"	23,9	24	62	88	10
51122212	029108	3/8"	23,9	24	62	92	10
51122214	029115	7/16"	23,9	24	62	102	10
51122216	029122	1/2"	23,9	24	62	115	10
51122218	029139	9/16"	25,9	24	62	151	10
51122220	029146	5/8"	25,9	24	62	156	10
51122222	029153	11/16"	25,9	24	62	161	10
51122224	029160	3/4"	25,9	24	62	168	10

5190 HI 1/2" INCH SOCKET DRIVER SET FOR HEX HEAD SCREWS

ITEM NO. 51901211

- Set in metal box with socket drivers for hex head screws from 3/16" to 3/4".
- 11 tools.

1/2"



5112HL 1/2" LONG SOCKET DRIVERS FOR HEX HEAD SCREWS

DIN 7422

- Surface: Satin chrome finish. Material: Chrome-vanadium steel.

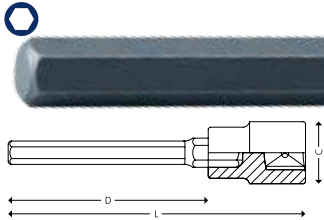

ITEM NO.	5704196+	SIZE	C	D	L	G	Icon
		MM	MM	MM	MM		
51122105	010816	5	23,9	100	138	111	10
51122106	010823	6	23,9	100	138	113	10
51122107	010830	7	23,9	100	138	114	10
51122108	003238	8	23,9	100	138	114	10
51122109	019017	9	23,9	100	138	115	10
51122110	003252	10	23,9	100	138	143	10
51122112	003269	12	23,9	100	138	130	10
51122114	003276	14	23,9	100	138	224	10
51122117	003283	17	25,9	100	138	306	10
51122119	003290	19	25,9	100	138	320	10

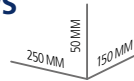

5704196 029177 2,2 KG 1

CONTENT:

QTY.	DESCRIPTION	SIZE
11	6-point socket drivers	5112 HI 1/2" 3/16 - 7/32 - 1/4 - 5/16 - 3/8 - 7/16 - 1/2 - 9/16 - 5/8 - 11/16 - 3/4"

5191 HL 1/2" LONG SOCKET DRIVER SET FOR HEX HEAD SCREWS

ITEM NO. 5191210

- Set in metal box with long socket drivers for hex head screws from 5 to 19 mm.
- 10 tools.

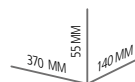

3,25 KG

5704196 000695

1

CONTENT:

QTY.	DESCRIPTION	SIZE
10	Long socket drivers for hex head screws	5112 1/2" HL 5 - 6 - 7 - 8 - 9 - 10 - 12 - 14 - 17 - 19 mm



POLAR® SOCKETS AND ACCESSORIES



5112 TX 1/2" SOCKET DRIVERS FOR TORX® SCREWS

■ Surface: Satin chrome finish. Material: Chrome-vanadium steel.

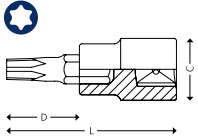

ITEM NO.	5704196+	TORX® NO.	★ MM	C MM	D MM	L MM	⚖ G	📦
51121020	003047	T20	3,86	23,9	24	62	59	10
51121025	003054	T25	4,43	23,9	24	62	84	10
51121027	003061	T27	4,99	23,9	24	62	90	10
51121030	003078	T30	5,52	23,9	24	62	88	10
51121040	003085	T40	6,65	23,9	24	62	89	10
51121045	003092	T45	7,82	23,9	24	62	90	10
51121050	003108	T50	8,83	23,9	24	62	91	10
51121055	003115	T55	11,22	23,9	24	62	94	10
51121060	003122	T60	13,25	23,9	24	62	104	10

5112TXL 1/2" LONG SOCKET DRIVERS FOR TORX® SCREWS

■ Surface: Satin chrome finish. Material: Chrome-vanadium steel.

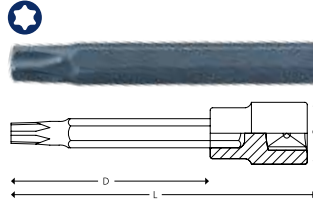

ITEM NO.	5704196+	TORX® NO.	★ MM	C MM	D MM	L MM	⚖ G	📦
51121120	013107	T20	3,86	23,9	100	138	119	10
51121125	013114	T25	4,43	23,9	100	138	119	10
51121127	013121	T27	4,99	23,9	100	138	120	10
51121130	013138	T30	5,52	23,9	100	138	120	10
51121140	013145	T40	6,65	23,9	100	138	121	10
51121145	013152	T45	7,82	23,9	100	138	121	10
51121150	013169	T50	8,83	23,9	100	138	122	10
51121155	013176	T55	11,22	23,9	100	138	143	10
51121160	013183	T60	13,25	23,9	100	138	176	10

5190 TX 1/2" SOCKET DRIVER SET FOR TORX® SCREWS

ITEM NO. 51901209

- Set in metal box with Torx® socket drivers from TX20 to TX60.
- 9 tools.



CONTENT:

QTY.	DESCRIPTION	SIZE
9	Socket drivers for Torx® screws	5112 1/2" TX T20 - T25 - T27 - T30 - T40 - T45 - T50 - T55 - T60

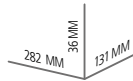

⚖ 1,5 KG

📦 5704196 000671

📦 1



9 TOOLS

5191 TXL 1/2" LONG SOCKET DRIVER SET FOR TORX® SCREWS

ITEM NO. 51911209

- Set in metal box with long Torx® socket drivers from TX20 to TX60.
- 9 tools.



CONTENT:

QTY.	DESCRIPTION	SIZE
9	Long socket drivers for Torx® screws	5112 1/2" TXL T20 - T25 - T27 - T30 - T40 - T45 - T50 - T55 - T60

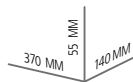

⚖ 2,3 KG

📦 5704196 013190

📦 1



9 TOOLS

POLAR® SOCKETS AND ACCESSORIES



5112 XZN 1/2" SOCKET DRIVERS FOR XZN® SCREWS

DIN 2324

- Surface: Satin chrome finish. Material: Chrome-vanadium steel.

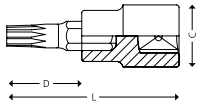

ITEM NO.	5704196+	SIZE	C MM	D MM	L MM	G	
51124005	029184	M5	23,9	24	62	88	10
51124006	029191	M6	23,9	24	62	89	10
51124008	029207	M8	23,9	24	62	90	10
51124009	029214	M9	23,9	24	62	93	10
51124010	029221	M10	23,9	24	62	94	10
51124012	029238	M12	23,9	24	62	104	10
51124014	029245	M14	23,9	24	62	116	10
51124016	029252	M16	23,9	24	62	156	10

5112 XZNL 1/2" LONG SOCKET DRIVERS FOR XZN® SCREWS

DIN 2324

- Surface: Satin chrome finish. Material: Chrome-vanadium steel.

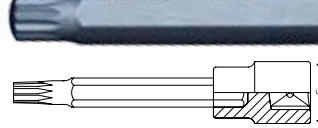

ITEM NO.	5704196+	SIZE	C MM	D MM	L MM	G	
51124105	029269	M5	23,9	100	138	119	10
51124106	029276	M6	23,9	100	138	120	10
51124108	029283	M8	23,9	100	138	120	10
51124109	029290	M9	23,9	100	138	143	10
51124110	029306	M10	23,9	100	138	145	10
51124112	029313	M12	23,9	100	138	177	10
51124114	029320	M14	23,9	100	138	214	10
51124116	029337	M16	23,9	100	138	301	10

5190 XZN 1/2" SOCKET DRIVER SET FOR XZN® SCREWS

ITEM NO. 5190-1208

- Set in metal box with socket drivers for XZN® screws from M5 to M16.
- 8 tools.

1/2"

CONTENT:

QTY.	DESCRIPTION	SIZE
8	Socket drivers for XZN® screws	5112 1/2" XZN M5 - M6 - M8 - M9 - M10 - M12 - M14 - M16



8
TOOLS



5191 XZNL 1/2" SOCKET DRIVER SET FOR XZN® SCREWS

ITEM NO. 5191-1208

- Set in metal box with long socket drivers for XZN® screws from M5 to M16.
- 8 tools.

1/2"

CONTENT:

QTY.	DESCRIPTION	SIZE
8	Long socket drivers for XZN® screws	5112 1/2" XZNL M5 - M6 - M8 - M9 - M10 - M12 - M14 - M16



8
TOOLS



POLAR® SOCKETS AND ACCESSORIES



5192 XZNLS 1/2" SOCKET DRIVER SET FOR XZN® SCREWS

ITEM NO. 5192-1208

- Set in metal box with short and long socket drivers for XZN® screws from M5 to M16.
- 8 tools.

1/2"

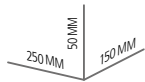

2,1 KG

5704196 029368

1



CONTENT:

QTY.	DESCRIPTION	SIZE
6	Long socket drivers for XZN® screws	5112 1/2" XZNL M6 - M8 - M9 - M10 - M12 - M14
2	Socket drivers for XZN® screws	5112 1/2" XZN M5 - M16

4712 1/2" SCREWDRIVER BIT SOCKET

ISO 1173-1174, DIN 3126.

- For use with 5/16" screwdriver bits.
- Surface: Satin chrome finish. Material: Chrome-vanadium steel.

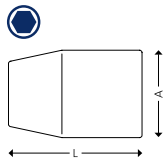

ITEM NO.	5704196+	5/16"	1/2"	A MM	L MM	G	10
47125012	010908			22	38,5	55	10

5212 EX 1/2" EXTENSIONS

ISO 3316, DIN 3123.

- With ext. 22 mm Hexagon.
- Surface: Satin chrome finish. Material: Chrome-vanadium steel.

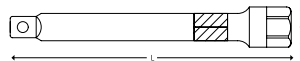

ITEM NO.	5704196+	L MM	A MM	G	10	IMPA CODE
52120075	003399	75	23	160	10	610453
52120125	003405	125	23	247	10	610454
52120250	003412	250	23	450	10	610455

5012 SP 1/2" SPARK PLUG SOCKETS

ISO 11168

- Rubber gasket for retaining the spark plug.
- Surface: Satin chrome finish. Material: Chrome-vanadium steel.

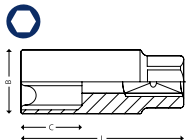

ITEM NO.	5704196+	SIZE MM	MM	B MM	L MM	G	10
50120516	032504	16	20	22	67	88	10
50120521	032498	21	24	27	67	138	10

POLAR® SOCKETS AND ACCESSORIES



5212 EX 1/2" EXTENSIONS WITH QUICK-RELEASE

ISO 3316, DIN 3123.

- Surface: Satin chrome finish. Material: Chrome-vanadium steel.

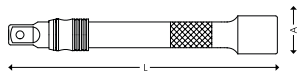

ITEM NO.	5704196+	L MM	A MM	G	
52122075	027777	75	22	128	10
52122125	027784	125	22	212	10
52122250	027791	250	22	418	10

5212 EXW 1/2" WOBBLE EXTENSIONS

- Can be used for both wobble and rigid functionality.
- The wobble function provides 15° of additional accessibility.
- With ext. 22 mm Hexagon.
- Surface: Satin chrome finish. Material: Chrome-vanadium steel.

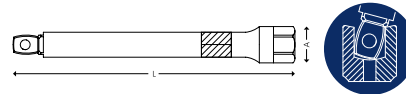

ITEM NO.	5704196+	L MM	A MM	G	
52121075	011066	75	24	160	10
52121125	011073	125	24	247	10
52121150	011080	150	24	280	10
52121250	021959	250	24	420	10
52121500	011097	500	24	850	10

5290 1/2" QUICK-RELEASE EXTENSION BAR SET

- Supplied in nylon bag.



ITEM NO.	5704196+	QTY.	SIZE MM	G	
52901203	027814	3	75 mm, 125 mm, 250 mm	850	1

5712 A 1/2" ADAPTOR FROM 1/2" TO 3/8"

ISO 3316, DIN 3123

- Surface: Satin chrome finish. Material: Chrome-vanadium steel.

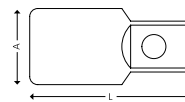

ITEM NO.	5704196+	□	■	A MM	L MM	G		IMPA CODE
57121238	003467	1/2"	3/8"	22	36	67	10	610474

5612 A 1/2" ADAPTOR FROM 1/2" TO 3/4"

ISO 3316, DIN 3123

- Surface: Satin chrome finish. Material: Chrome-vanadium steel.

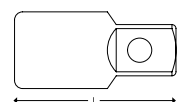

ITEM NO.	5704196+	□	■	A MM	L MM	G		IMPA CODE
56121234	003474	1/2"	3/4"	25	50	140	10	610475





POLAR® SOCKETS AND ACCESSORIES



5412 TH 1/2" SLIDING T-HANDLE

ISO 3315, DIN 3122

- Surface: Satin chrome finish. Material: Chrome-vanadium steel.

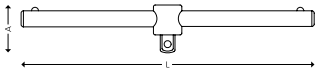

ITEM NO.	5704196+	L MM	A MM	G	IMPA CODE
54120012	003450	250	42	372	10 610423

5912 FH 1/2" SWIVEL HANDLE

ISO 3315, DIN 3122.

- Heavy duty model.
- Surface: Satin chrome finish.
- Material: Handle in chrome-vanadium steel.
Head in chrome-molybdenum steel.

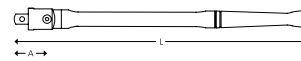

ITEM NO.	5704196+	L MM	A MM	G	IMPA CODE
59120410	003429	410	56	990	6 610417
59120645	003436	645	56	1380	10 610418

5512 SB 1/2" SPEED BRACE

- 1/2" speed brace with rotating plastic handle.
- Surface: Satin chrome finish. Material: Chrome-vanadium steel.

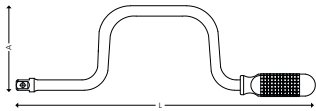

ITEM NO.	5704196+	L MM	A MM	G	IMPA CODE
55120012	027722	420	110	500	10

5312 E 1/2" REVERSIBLE RATCHET WITH LOCKING SYSTEM

ISO 3315, DIN 3122

- Model with 60 teeth and Quick Release.
- Compact head with a working angle of 6°.
- Surface: Satin chrome finish. Material: Chrome-vanadium steel.

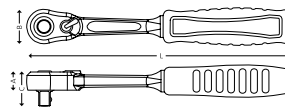

ITEM NO.	5704196+	A MM	B MM	C MM	L MM	G	IMPA CODE
53120060	027357	16	36	33	255	446	1

5812 U 1/2" UNIVERSAL JOINT

ISO 3316, DIN 3123

- Equipped with tension-spring.
- Joint stays at desired angle.
- Surface: Satin chrome finish. Material: Chrome-vanadium steel.

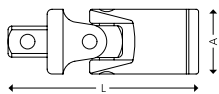

ITEM NO.	5704196+	L MM	A MM	G	IMPA CODE
58120012	003443	75	25	160	10 610467



POLAR® SOCKETS AND ACCESSORIES

3/4" SOCKETS AND ACCESSORIES

5034 3/4" 6-POINT METRIC SOCKETS

ISO 2725-1, DIN 3124

- Surface: Chrome plated finish. Material: Chrome-vanadium steel.

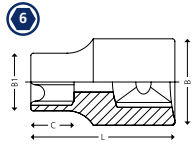

ITEM NO.	5704196+	SIZE MM	B MM	B1 MM	C MM	L MM	G	IMPA CODE
50340019	003498	19	33,0	29,2	14	50	170	5 610301
50340021	003504	21	33,0	31,2	14	50	190	5 610302
50340022	003511	22	36,0	32,2	14	50	220	5 610303
50340024	003528	24	36,0	34,2	16	51	230	5 610305
50340027	003535	27	36,0	38,0	22	52	240	5 610307
50340030	003542	30	38,0	42,0	24	54	280	5 610309
50340032	003559	32	38,0	44,0	26	56	310	5 610310
50340036	003566	36	42,0	50,0	28	58	430	5 610312
50340038	003573	38	45,0	52,0	28	60	500	5 610313
50340041	003580	41	45,0	56,0	30	64	570	5 610314
50340046	003597	46	48,0	62,0	34	68	700	5 610315
50340050	003603	50	48,0	68,0	36	72	850	5 610316



5434 TH 3/4" SLIDING T-HANDLE

ISO 3315, DIN 3122

- Surface: Chrome plated finish. Material: Chrome-vanadium steel.



ITEM NO.	5704196+	L MM	A MM	G	IMPA CODE
54340450	003641	450	60	1380	1 610424

5934 FH 3/4" SWIVEL HANDLE - 500 MM

ISO 3315, DIN 3122

- Surface: Chrome plated finish. Material: Chrome-vanadium steel.

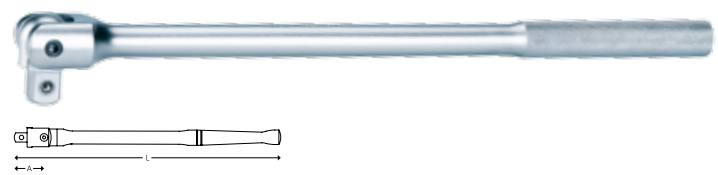

ITEM NO.	5704196+	L MM	A MM	G	IMPA CODE
59340475	003658	532	57	1850	1 610419

5234 EX 3/4" EXTENSIONS

ISO 3316, DIN 3123

- Surface: Chrome plated finish. Material: Chrome-vanadium steel.

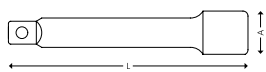

ITEM NO.	5704196+	L MM	A MM	G	IMPA CODE
52340100	003610	100	36	410	1
52340200	003627	200	36	710	1 610456

5934 FH 3/4" SWIVEL HANDLE - 1000 MM

ISO 3315, DIN 3122

- Surface: Chrome plated finish. Material: Chrome-vanadium steel.



ITEM NO.	5704196+	L MM	A MM	G	IMPA CODE
59341000	017129	1000	85	3650	1

5734 A 3/4" ADAPTOR FROM 3/4" TO 1/2"

ISO 3316, DIN 3123

- Surface: Chrome plated finish. Material: Chrome-vanadium steel.



ITEM NO.	5704196+	3/4"	1/2"	A MM	L MM	G	IMPA CODE
57343412	003634	3/4"	1/2"	34	54	170	5 610476



5334 3/4" REVERSIBLE RATCHET

ISO 3315, DIN 3122

- Model with 48 teeth. Working angle of 9°.
- Surface: Chrome plated finish. Material: Chrome-vanadium steel.

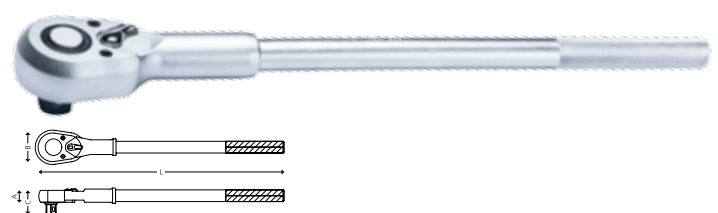

ITEM NO.	5704196+	A MM	B MM	C MM	L MM	G	IMPA CODE
53340048	003655	32,4	65,5	58	500	2850	1 610407

POLAR® SOCKETS AND ACCESSORIES



1" SOCKETS AND ACCESSORIES

5001 1" 6-POINT METRIC SOCKETS

ISO 2725-2, DIN 3129

■ Surface: Chrome plated finish. Material: Chrome-vanadium steel.

6

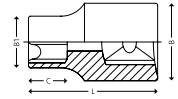

5704196+	SIZE MM	B MM	B1 MM	C MM	L MM	G	
026404	36	45	52,0	28	65	470	1
026411	41	45	57,0	32	70	570	1
026428	46	50	65,0	34	75	870	1
026435	50	50	70,0	34	75	1050	1
026442	55	55	76,0	40	80	1250	1
026459	60	55	82,0	42	84	1500	1
026466	65	55	88,0	44	87	1660	1
026473	70	60	94,0	48	93	2200	1
026480	75	60	100,0	52	87	2400	1
026497	80	60	105,0	54	103	3000	1

5634 A 3/4" ADAPTOR FROM 3/4" TO 1"

ISO 3316, DIN 3123

■ Surface: Chrome plated finish. Material: Chrome-vanadium steel.

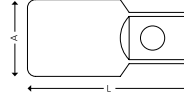

5704196+			A MM	L MM	G	
026541	3/4"	1	38	62	390	1

5401 TH 1" SLIDING T-HANDLE

ISO 3316, DIN 3123

■ Surface: Chrome plated finish. Material: Chrome-vanadium steel.

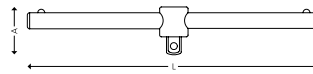

5704196+	L MM	A MM	G	
026565	550	80	3340	1

5201 EX 1" EXTENSIONS

ISO 3316, DIN 3123.

■ Surface: Chrome plated finish. Material: Chrome-vanadium steel.

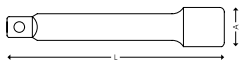

5704196+	L MM	A MM	G	
026510	150	48	1100	1
026527	200	48	1350	1
026534	400	48	2480	1

5301 1" REVERSIBLE RATCHET

ISO 3315, DIN 3122

■ Model with 24 teeth. Working angle of 15°.

■ Surface: Chrome plated finish. Material: Chrome-vanadium steel.

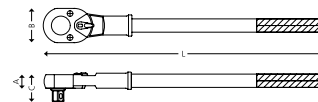

5704196+	A MM	B MM	C MM	L MM	G	
026503	33,8	71,5	66,7	670	4410	1

5701 A 1" ADAPTOR FROM 1" TO 3/4"

ISO 3316, DIN 3123

■ Surface: Chrome plated finish. Material: Chrome-vanadium steel.

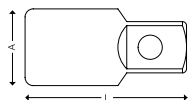

5704196+			A MM	L MM	G	
026558	1"	3/4"	48	65	440	1

5901 FH 1" SWIVEL HANDLE - 1000 MM

ISO 3316, DIN 3123

■ Surface: Chrome plated finish. Material: Chrome-vanadium steel.

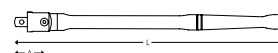

5704196+	L MM	A MM	G	
026398	1000	87	3820	1



AIR TOOLS

POLAR® Air tools are designed to work comfortably and feature heavy duty components to resist the everyday use.

POLAR® offers a very wide range of air tools, which combines power and durability.

- Compact design – allows easy access to tight spaces
- Twin hammer impact mechanisms – performing maximum power
- Reduced vibration – shock absorption reduce the stress from vibration
- Balanced design – for better user control
- Low noise – for a comfortable working environment
- Comfort grip – ergonomic grip, to take the strain out of repetitive use.







POLAR® AIR TOOLS

IMPACT WRENCHES

POLAR® Composite impact wrenches are all manufactured with the durable and hard hitting twin hammer mechanism. Choose among eight different models.



Composite motor housing



Forward/Reverse and speed level by one-hand switching



3 speed regulator



Handle exhaust

6100 C 1/2" MINI IMPACT WRENCH

ITEM NO. 61000012

▲ 1,3 KG L 122 MM

▮ 5704196 019758 IMPA CODE 590101

📦 1

- Composite motor housing.
- Lightweight.
- Handle exhaust. Twin hammer.
- One hand push button forward / reverse.
- Compact design for narrow space.
- Steel ring to retain the sockets.

TECHNICAL DATA:

Working torque: 50 - 550 Nm
 Max. torque: 610 Nm
 Speed: 9.000 RPM
 Noise level: 89 db(A)
 Air inlet: 1/4"
 Hose size: 3/8" (10 mm)
 Air consumption: 120 L/Min



1/2"

6100 C1 1/2" IMPACT WRENCH

ITEM NO. 61001012

▲ 1,9 KG L 165 MM

▮ 5704196 019765

📦 1

IMPA CODE 590101

- Composite motor housing.
- Lightweight.
- Handle exhaust. Twin hammer.
- One hand push button forward / reverse.
- Steel ring to retain the sockets.

TECHNICAL DATA:

Working torque: 70 - 880 Nm
 Max. torque: 1.220 Nm
 Speed: 6.500 RPM
 Noise level: 89 db(A)
 Air inlet: 1/4"
 Hose size: 3/8" (10 mm)
 Air consumption: 135 L/Min



W

1/2"



Forward/Reverse by one-hand switching



3 speed regulator



Handle exhaust

6100 B 3/8" IMPACT WRENCH

ITEM NO. 61000038

▲ 1,2 KG L 153 MM

▮ 5704196 019987

📦 1

- Composite motor housing.
- Lightweight.
- Handle exhaust.
- Twin hammer clutch mechanism.
- One hand push button forward/reverse.
- Steel ring to retain the sockets.

TECHNICAL DATA:

Working torque: 34 - 338 Nm
 Max. torque: 410 Nm
 Speed: 11.000 RPM
 Noise level: 83 db(A)
 Air inlet: 1/4"
 Hose size: 3/8" (10 mm)
 Air consumption: 113 L/Min



6100 C2 1/2" IMPACT WRENCH

ITEM NO. 61002012

▲ 2,1 KG L 186 MM

▮ 5704196 019772

📦 1

IMPA CODE 590101

- Composite motor housing.
- Silenced handle exhaust.
- Twin hammer.
- Steel ring to retain the sockets.

TECHNICAL DATA:

Working torque: 68 - 746 Nm
 Max. torque: 813 Nm
 Speed: 9.000 RPM
 Noise level: 84 db(A)
 Air inlet: 1/4"
 Hose size: 3/8" (10 mm)
 Air consumption: 120 L/Min



POLAR® AIR TOOLS



6100 D 3/4" IMPACT WRENCH

ITEM NO. 61000034

3,3 KG L 215 MM

5704196 019789

1

IMPA CODE 590105



- Composite motor housing.
- Lightweight.
- Handle exhaust.
- Twin hammer clutch mechanism.
- One hand push button forward/reverse.
- Steel ring to retain the sockets..

TECHNICAL DATA:

Working torque: 271 - 1627 Nm
 Max. torque: 1.898 Nm
 Speed: 5.500 RPM
 Noise level: 90 db(A)
 Air inlet: 3/8"
 Hose size: 1/2" (13 mm)
 Air consumption: 198 L/Min

6100 E2 1" IMPACT WRENCH

ITEM NO. 61002010

3,4 KG L 223 MM

5704196 019994

1

IMPA CODE 590106



- Composite motor housing.
- Lightweight.
- Handle exhaust.
- Twin hammer clutch mechanism.
- One hand push button forward/reverse.
- Steel ring to retain the sockets..

TECHNICAL DATA:

Working torque: 271-1627 Nm
 Max. torque: 1.898 Nm
 Speed: 5.500 RPM
 Noise level: 90 db(A)
 Air inlet: 3/8"
 Hose size: 1/2" (13 mm)
 Air consumption: 198 L/Min

6100 E 1" IMPACT WRENCH

ITEM NO. 61000010

5704196 019796

L 412 MM

10 KG

1

IMPA CODE 590106



- Side handle for better control.
- Handle with inside trigger.
- Steel ring to retain the sockets.
- Twin hammer clutch mechanism.

TECHNICAL DATA:

Working torque: 542 - 2441 Nm
 Max. torque: 3.119 Nm
 Speed: 5.000 RPM
 Noise level: 109 db(A)
 Air inlet: 1/2"
 Hose size: 1/2" (13 mm)
 Air consumption: 282 L/Min



Forward/Reverse
and speed level

6100 E1 1" IMPACT WRENCH WITH 8" LONG ANVIL

ITEM NO. 61001010

5704196 019802

L 520 MM

11 KG

1



- Side handle for better control.
- Handle with inside trigger.
- Steel ring to retain the sockets.
- Twin hammer clutch mechanism.

TECHNICAL DATA:

Working torque: 542 - 2441 Nm
 Max. torque: 3.119 Nm
 Speed: 5.000 RPM
 Noise level: 109 db(A)
 Air inlet: 1/2"
 Hose size: 1/2" (13 mm)
 Air consumption: 282 L/Min



Forward/Reverse
and speed level



RATCHETS

All POLAR® Ratchets are manufactured with needle bearings, providing a smooth running tool.



6105 A 1/4" STUBBY RATCHET

ITEM NO. 61050014 5704196 019819 L 133 MM 0,4 KG 1



- Composite motor housing.
- Short and compact size.
- Rear exhaust.

TECHNICAL DATA:

Max. torque: 40,7 Nm	Hose size: 3/8" (10 mm)
Speed: 350 RPM	Air consumption: 113 L/Min
Noise level: 85 db(A)	
Air inlet: 1/4"	

6105 B 3/8" STUBBY RATCHET WITH WOBBLE-SQUARE

ITEM NO. 61051038 5704196 019826 L 133 MM 0,5 KG 1



- Composite motor housing.
- Short and compact size. Rear exhaust.
- Wobble function provides 15° of additional accessibility.

Wobble-square

TECHNICAL DATA:

Max. torque: 40,7 Nm	Hose size: 3/8" (10 mm)
Speed: 350 RPM	Air consumption: 113 L/Min
Noise level: 85 db(A)	
Air inlet: 1/4"	

6105 B1 3/8" RATCHET

ITEM NO. 61050038 5704196 019833 L 256 MM 1,2 KG 1



- Cushioned grip. Strong ratchet head.
- Rotating air inlet. Rotating rear exhaust with silencer.

TECHNICAL DATA:

Working torque: 14 - 68 Nm	Air inlet: 1/4"
Max. torque: 68 Nm	Hose size: 3/8" (10 mm)
Speed: 150 RPM	Air consumption: 113 L/Min
Noise level: 79 db(A)	

6105 C 1/2" RATCHET

ITEM NO. 61050012 5704196 019840 L 256 MM 1,2 KG 1



- Cushioned grip. Strong ratchet head.
- Rotating air inlet. Rotating rear exhaust with silencer.

TECHNICAL DATA:

Working torque: 14 - 68 Nm	Air inlet: 1/4"
Max. torque: 68 Nm	Hose size: 3/8" (10 mm)
Speed: 150 RPM	Air consumption: 113 L/Min
Noise level: 79 db(A)	



GRINDERS

POLAR® Mini grinders with ergonomic handles are contoured to fit comfortably in the hand, as well as absorb vibration.



6110 A MINI GRINDER

ITEM NO. 61100000 5704196 019659 L 163 MM 0,4 KG 1

IMPA CODE 590326



- Comfort grip.
- Rotating rear regulator. Safety throttle lever.
- Rear exhaust with silencer. Rotating air inlet.

TECHNICAL DATA:

Speed: 25.000 RPM Hose size: 3/8" (10 mm)
Collet size: 1/4" (6 mm) Air consumption: 113 L/Min
Noise level: 77 db(A)
Air inlet: 1/4"

6110 C MINI GRINDER, 115° ANGLE HEAD

ITEM NO. 61100115 5704196 019673 L 200 MM 0,5 KG 1



- Comfort grip. Rotating rear regulator. Safety throttle lever.
- Rear exhaust with silencer. Rotating air inlet.

TECHNICAL DATA:

Speed: 20.000 RPM Hose size: 3/8" (10 mm)
Collet size: 1/4" (6 mm) Air consumption: 113 L/Min
Noise level: 77 db(A)
Air inlet: 1/4"

6110 B MINI GRINDER, 90° ANGLE HEAD

ITEM NO. 61100090 5704196 019666 L 166 MM 0,5 KG 1



- Comfort grip. Rotating rear regulator. Safety throttle lever.
- Rear exhaust with silencer. Rotating air inlet.

TECHNICAL DATA:

Speed: 20.000 RPM Hose size: 3/8" (10 mm)
Collet size: 1/4" (6 mm) Air consumption: 113 L/Min
Noise level: 77 db(A)
Air inlet: 1/4"

6110 D MINI GRINDER, 3" CUT-OFF TOOL

ITEM NO. 61101075 5704196 019680 L 203 MM 0,8 KG 1



- Comfort grip.
- Rotating rear regulator. Safety throttle lever.
- Rear exhaust with silencer. Rotating air inlet.

TECHNICAL DATA:

Speed: 20.000 RPM Hose size: 3/8" (10 mm)
Disc size: 3" (75 mm) Air consumption: 113 L/Min
Noise level: 79 db(A)
Air inlet: 1/4"



6110 | INDUSTRIAL DIE GRINDER

ITEM NO. 61101000

5704196 029825

L 200 MM

0,8 KG

1



- Powerful 0,75 kW / 1.0 HP motor.
- Comfort grip.
- Rotating rear regulator.
- Safety throttle lever.
- Rear exhaust with silencer.
- Rotating air inlet.

TECHNICAL DATA:

Speed: 22.000 RPM	Vibration level: 0,46 m/s ²
Collet size: 1/4" (6 mm)	Hose size: 3/8" (10 mm)
Noise level: 87 db(A)	Air consumption: 150 L/Min
Air inlet: 1/4"	Rated power: 0,75 kW / 1 HP

6110 IE EXTENDED DIE GRINDER

ITEM NO. 61101100

5704196 029832

L 330 MM

1,2 KG

1



- Powerful 0,75 kW / 1.0 HP motor.
- Comfort grip.
- Rotating rear regulator.
- Safety throttle lever.
- Rear exhaust with silencer.
- Rotating air inlet.

TECHNICAL DATA:

Speed: 22.000 RPM	Vibration level: 0,46 m/s ²
Collet size: 1/4" (6 mm)	Hose size: 3/8" (10 mm)
Noise level: 87 db(A)	Air consumption: 150 L/Min
Air inlet: 1/4"	Rated power: 0,75 kW / 1 HP



POLAR® AIR TOOLS



GRINDERS, POLISHER & SANDERS

6120 A 5" ANGLE GRINDER

ITEM NO. 61200125

5704196 019710

L 238 MM

2 KG

1



Easy disc change



Rear exhaust

- Composite motor housing.
- 9 position adjustable swivel guard. Side handle.
- Spindle lock allows quick and easy disc change.
- Powerful 0,75 HP motor. Low noise level.

TECHNICAL DATA:

Speed:	10.000 RPM	Air inlet:	1/4"
Disc size:	5" (125 mm)	Hose size:	3/8" (10 mm)
Spindle thread:	M14 x 2.0	Air consumption:	113 L/Min
Noise level:	83 db(A)		
Power:	0,7 HP (0,52 Kw)		

6120 B 7" ANGLE GRINDER

ITEM NO. 61200175

5704196 019727

L 355 MM

3,3 KG

1

IMPA CODE 590302



Easy disc change

- Spindle lock allows quick and easy disc change.
- Push button lock off lever. Rubber comfort grip.
- Front exhaust.

TECHNICAL DATA:

Speed:	8.500 RPM	Air inlet:	3/8"
Disc size:	7" (175 mm)	Hose size:	3/8" (10 mm)
Spindle thread:	5/8" - 11	Air consumption:	113 L/Min
Noise level:	89 db(A)		
Power:	1,3 HP (0,97 Kw)		

6125 LONG ANGLE GRINDER, 4" CUT-OFF TOOL

ITEM NO. 61250100

5704196 019734

L 377 MM

1,7 KG

1



- Spindle lock allows quick and easy disc change. Rear exhaust.
- Built-in cushion grip. Push to adjust guard.
- 11 position adjustable swivel guard.

TECHNICAL DATA:

Speed:	14.000 RPM	Air inlet:	1/4"
Disc size:	4" (100 mm)	Hose size:	3/8" (10 mm)
Disc hole:	3/8" (10)	Air consumption:	113 L/Min
Noise level:	87 db(A)		
Power:	1,0 HP (0,75 Kw)		

6127 7" ANGLE POLISHER

ITEM NO. 61270175

5704196 019741

L 307 MM

1,9 KG

1



- Rubber comfort grip. Safety lever.
- Spindle lock button. Rear exhaust.

TECHNICAL DATA:

Speed:	2.500 RPM	Hose size:	3/8" (10 mm)
Pad size:	7" (175 mm)	Air consumption:	91 L/Min
Spindle thread:	5/8" - 11		
Air inlet:	1/4"		



6113 5" REVERSIBLE HIGH SPEED SANDER

ITEM NO. 61130125

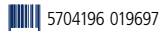

5704196 019697

L 142 MM

1 KG



- Composite motor housing.
- Reversing bar on both sides.
- Handle exhaust.

TECHNICAL DATA:

Speed: 16.000 RPM
 Pad size: 3" - 4" - 5"
 Noise level: 83 db(A)
 Power: 0,6 HP (0,45 Kw)
 Air inlet: 3/8"
 Hose size: 3/8" (10 mm)
 Air consumption: 113 L/Min

6115 5" RANDOM ORBITAL SANDER

ITEM NO. 61150150

0,7 KG

L 196 MM

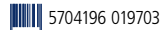

5704196 019703



- Composite motor housing.
- Exhaust to central-vacuum system.
- Low vibration.
- Lightweight.
- Low noise level.

TECHNICAL DATA:

Speed:	12.000 RPM	Power:	0,6 HP (0,45 Kw)
Orbit diameter:	5 mm	Air inlet:	1/4"
Pad size:	5" (125 mm)	Hose size:	3/8" (10 mm)
Spindle thread:	5/16"	Air consumption:	57 L/Min
Noise level:	84 db(A)		
Vibration level:	1,2 m/s ²		

6145 A BELT SANDER - 10 MM

ITEM NO. 61450010

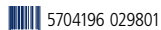

L 305 MM

0,9 KG



- Rubber comfort grip.
- Safety throttle lever.
- Rear exhaust.
- Rotating air inlet.

TECHNICAL DATA:

Speed:	20.000 RPM	Vibration level:	1,3 m/s ²
Belt size:	10 x 330 mm	Hose size:	3/8" (10 mm)
Air inlet:	1/4"	Air consumption:	110 L/Min
Noise level:	86 db(A)		

6145 B BELT SANDER - 20 MM

ITEM NO. 61450020

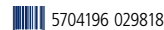

L 376 MM

1,5 KG



- Rubber comfort grip.
- Safety throttle lever.
- Rear exhaust.
- Rotating air inlet.

TECHNICAL DATA:

Speed:	18.000 RPM	Vibration level:	2,5 m/s ²
Belt size:	20 x 520 mm	Hose size:	3/8" (10 mm)
Air inlet:	1/4"	Air consumption:	119 L/Min
Noise level:	84 db(A)		

POLAR® AIR TOOLS



DRILLS & RIVETERS

6130 A DRILL, 10 MM

ITEM NO. 61300010 5704196 019857 L 185 MM 1,1 KG 1
 IMPA CODE 590342



- Composite motor housing.
- Two speed trigger.
- Reversing bar on both sides.
- Keyless chuck.

TECHNICAL DATA:

Speed: 1.800 RPM
 Chuck size: 3/8" (10 mm)
 Noise level: 83 db(A)
 Power: 0,5 HP (0,37 Kw)
 Air inlet: 1/4"
 Hose size: 3/8" (10 mm)
 Air consumption: 113 L/Min

6130 B DRILL, 13 MM

ITEM NO. 61300013 5704196 019864 L 218 MM 1,3 KG 1
 IMPA CODE 590347



- Composite motor housing.
- Two speed trigger.
- Reversing bar on both sides.
- Keyless chuck.

TECHNICAL DATA:

Speed: 800 RPM
 Chuck size: 1/2" (13 mm)
 Noise level: 83 db(A)
 Power: 0,5 HP (0,37 Kw)
 Air inlet: 1/4"
 Hose size: 3/8" (10 mm)
 Air consumption: 113 L/Min

6160 3/16" AIR HYDRAULIC RIVETER

ITEM NO. 6160-0014 5704196 029771 HxL 27x23 CM 1,5 KG 1



- Lightweight cast aluminum body.
- Machined chrome plated steel nosepiece.
- Air relief valve prevents overloading.
- Safety cap collects spent rivet pins.
- Nose pieces in 2.4 - 3.2 - 4.0 and 4.8 mm
- Rivet material: Aluminium, steel and stainless steel.

TECHNICAL DATA:

Tool stroke: 14 mm
 Traction power: 1219 kg
 Air inlet: 1/4"
 Rivet capacity: 2.4 - 4.8 mm
 (3/32"-3/16")
 Hose size: 1/2" (13 mm)
 Noise level: 77,8 db(A)
 Vibration level: 1,2 m/s²

6160 1/4" HEAVY-DUTY AIR HYDRAULIC RIVETER

ITEM NO. 6160-0016 5704196 029788 HxL 32x26 CM 2 KG 1



- Lightweight cast aluminum body.
- Machined chrome plated steel nosepiece.
- Air relief valve prevents overloading.
- Safety cap collects spent rivet pins.
- Nose pieces in 2.4 - 3.2 - 4.0 - 4.8 - 5.6 and 6.4 mm
- Rivet material: Aluminium, steel and stainless steel.

TECHNICAL DATA:

Tool stroke: 16 mm
 Traction power: 1894 kg
 Air inlet: 1/4"
 Rivet capacity: 2.4 - 6.4 mm
 (3/32" - 1/4")
 Hose size: 1/2" (13 mm)
 Noise level: 81,2 db(A)
 Vibration level: 0,6 m/s²



HAMMER & NEEDLE SCALERS

6135 HAMMER WITH HEX-SHANK

ITEM NO. 61350001 5704196 019871 L 133 MM 1,2 KG 1
IMPA CODE 590352



TECHNICAL DATA:

Blows per minute: 5.000 BPM
Stroke length: 1 5/8" (41 mm)
Air inlet: 1/4"
Hose size: 3/8" (10 mm)
Air consumption: 113 L/Min

6135 S/4 CHISEL SET

■ Set with 4 Hex-shank chisels (5"):
Tapered punch chisel, flat chisel, panel cutter and spot weld breaker.



ITEM NO. 5704196+ G 1
61350004 021621 398 1

6135 AIR HAMMER KIT

ITEM NO. 61359008

- Set in plastic case with air hammer, chisels and accessories.
- 8 tools.

8 TOOLS



5704196 023250 2,3 KG 1

CONTENT:

QTY.	DESCRIPTION
1	Air Hammer (6135)
5	5" Chisels: Tapered punch chisel, flat chisel, panel cutter, spot weld breaker and tailpipe cutter.
1	1/4" Nipple
1	1/4" Mini oiler (6910)

6137 A NEEDLE SCALER - STRAIGHT

ITEM NO. 61370001 5704196 019888 L 376 MM 2,6 KG 1
IMPA CODE 590462



TECHNICAL DATA:

Blows per minute: 3.000 BPM
Needle diameter: 3 mm
Qty. needles: 19 pcs.
Air inlet: 1/4"
Hose size: 3/8" (10 mm)
Air consumption: 113 L/Min

6137 B NEEDLE SCALER - PISTOL

ITEM NO. 61370002 5704196 019895 L 315 MM 2,6 KG 1
IMPA CODE 590464



TECHNICAL DATA:

Blows per minute: 3.000 BPM
Needle diameter: 3 mm
Qty. needles: 19 pcs.
Air inlet: 1/4"
Hose size: 3/8" (10 mm)
Air consumption: 113 L/Min

POLAR® AIR TOOLS



6915 TIRE INFLATING GUN WITH CLAMPING NIPPLE

ITEM NO. 69150001 5704196 029870 350 G 1



- Material: Acetal plastic and stainless steel.

TECHNICAL DATA:

Hose length: 0,5 mtr. with clamping nipple Ø 63
 Gauge: 0-12 Bar / 0-174 psi (class 1,6, EN 837-1)
 Air inlet: 1/4"

6920 BLOWGUN WITH Ø 8 MM BENT PIPE

ITEM NO. 69200001 5704196 029887 106 G 1

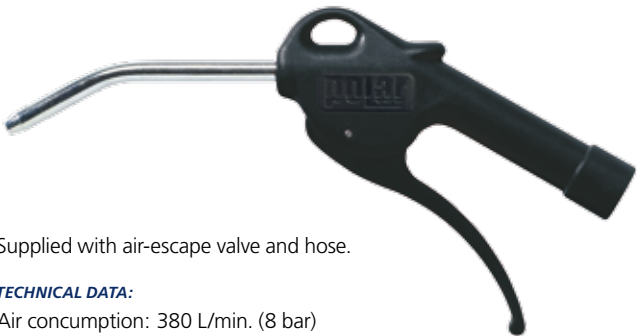

- Supplied with air-escape valve and hose.

TECHNICAL DATA:

Air consumption: 380 L/min. (8 bar)
 Air pressure: Max 16 bar
 Air inlet: 1/4"

6921 BLOWGUN WITH Ø 8 x 500 MM STRAIGHT PIPE

ITEM NO. 69210001 5704196 029894 127 G 1

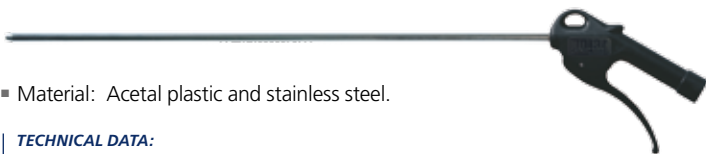

- Material: Acetal plastic and stainless steel.

TECHNICAL DATA:

Air consumption: 380 L/min. (8 bar)
 Air pressure: Max 16 bar
 Air inlet: 1/4"

6909 GREASE GUN / LUBRICATION GREASE

- Recommended for mechanical and air tool maintenance.
- Working temperature: -20° C ~ 180°C.



ITEM NO.	5704196+	PRODUCT DESCRIPTION	G	1
69090001	031699	Grease gun with lubrication grease	222	1
69090002	031705	Grease gun	82	1
69090003	031712	Lubrication grease (100 g)	112	1

6910 A AIRTOOL OIL

- Reliable protection.
- Mist lubrication applications.
- Specifications and approvals: ISO 6743-11, Types PAC and PBC.



ITEM NO.	5704196+	SIZE ML	G	1
69100010	024967	100	98	1
69100010	021997	1000	888	1

6910 1/4" MINI OILER

- Provides automatic lubrication of pneumatic air tools.



ITEM NO.	5704196+	G	1
69100014	021591	77	1

6100 SERVICE KITS

- Find all spareparts on polartools.com.



6100 REBUILD KITS

- Find all spareparts on polartools.com.





IMPACT SOCKETS AND ACCESSORIES

POLAR® offers an extended range of impact sockets and accessories made of chrome-molybdenum steel and phosphatised finish for a stronger and more durable tool. The range includes sizes from 3/8" square to 1 1/2" square and 6 to 120 mm.

- Sockets
- Bit sockets
- Torsion bars
- Extensions
- Adaptors
- Universal joints

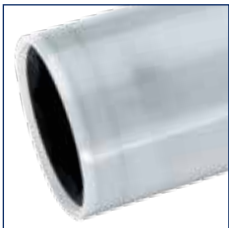

POLAR® IMPACT SOCKETS AND ACCESSORIES

3/8" IMPACT SOCKETS AND ACCESSORIES

6038 3/8" 6-POINT METRIC IMPACT SOCKETS

ISO 2725-2, DIN 3129

- Surface: Phosphatised finish. Material: Chrome-molybdenum steel.

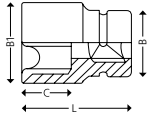

ITEM NO.	5704196+	SIZE MM	B MM	B1 MM	C MM	L MM	G	
60380006	023267	6	19	11,0	10	32	34	1
60380007	023274	7	19	12,5	12	32	34	1
60380008	023281	8	19	13,5	12	32	34	1
60380009	023298	9	19	14,5	12	32	36	1
60380010	023304	10	19	15,8	12	32	36	1
60380011	023311	11	19	17,0	12	32	36	1
60380012	023328	12	19	18,0	12	32	38	1
60380013	023335	13	22	19,5	12	32	52	1
60380014	023342	14	22	20,8	12	32	54	1
60380015	023359	15	22	22,0	10	32	57	1
60380016	023366	16	22	23,8	11	32	62	1
60380017	023373	17	22	25,0	11	32	60	1
60380018	023380	18	22	26,0	10	32	64	1
60380019	023397	19	22	27,8	10	32	73	1
60380020	023403	20	22	30,0	17	32	73	1
60380021	023410	21	22	30,0	17	32	68	1
60380022	023427	22	22	32,0	15	32	84	1
60380024	023434	24	22	34,0	16	32	74	1

6138 TW 3/8" METRIC IMPACT SOCKETS

ISO 1174, DIN 3120

- Twist sockets for removal rounded or damaged fasteners with almost any head configuration.
- Surface: Phosphatised finish. Material: Chrome-molybdenum steel.

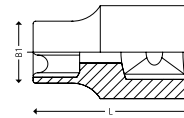

ITEM NO.	5704196+	SIZE MM	B1 MM	L MM	G	
61385011	025605	11	16,0	32	34	1
61385012	025612	12	18,0	32	36	1
61385013	025629	13	18,5	32	57	1
61385014	025636	14	20,5	32	57	1
61385015	025643	15	22,0	32	57	1
61385016	025650	16	22,5	32	58	1
61385017	025667	17	24,5	32	77	1
61385019	025674	19	27,0	32	93	1

6238 EX 3/8" EXTENSIONS

- Surface: Phosphatised finish. Material: Chrome-molybdenum steel.



ITEM NO.	5704196+	L MM	A MM	G	
62380075	023625	75	19	85	1
62380125	023632	125	19	123	1

6190 TW 3/8" TWIST IMPACT SOCKET SET

- Set in metal box with twist impact sockets from 11 to 19 mm.
- 8 tools.

3/8"

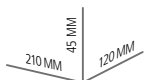

1,2 KG

5704196 027890

CONTENT:

QTY.	DESCRIPTION	SIZE
8	Twist impact sockets	6138 3/8" TW 11 - 12 - 13 - 14 - 15 - 16 - 17 - 19 mm

8
TOOLS



6614 A 1/4" ADAPTOR FROM 1/4" TO 3/8"

■ Surface: Phosphatised finish. Material: Chrome-molybdenum steel.

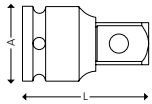

ITEM NO.	5704196+			A MM	L MM		
66141438	023595	1/4"	3/8"	14	26	18	1

6638 A 3/8" ADAPTOR FROM 3/8" TO 1/2"

■ Surface: Phosphatised finish. Material: Chrome-molybdenum steel.

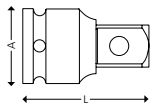

ITEM NO.	5704196+			A MM	L MM		
66383812	016429	3/8"	1/2"	22	38	64	1

6838 U 3/8" UNIVERSAL JOINT

■ Surface: Phosphatised finish. Material: Chrome-molybdenum steel.

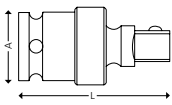

ITEM NO.	5704196+	L MM	A MM		
68380038	023618	53	27	105	1

6038 SR 3/8" SAFETY SET

■ Includes safety ring and pin.



ITEM NO.	5704196+	SIZE		
60389301	030203	6038 3/8" 6-12 mm	2	1
60389302	030210	6038 3/8" 12-22 mm	2	1



POLAR® IMPACT SOCKETS AND ACCESSORIES

1/2" IMPACT SOCKETS AND ACCESSORIES

6012 1/2" 6-POINT METRIC IMPACT SOCKETS

ISO 2725-2, DIN 3129

▪ Surface: Phosphatised finish. Material: Chrome-molybdenum steel.

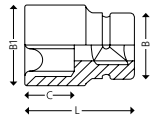

ITEM NO.	5704196+	SIZE MM	B MM	B1 MM	C MM	L MM	G	
60120008	023441	8	24	14,0	15	38	55	1
60120009	023458	9	24	16,0	14	38	60	1
60120010	016054	10	25	17,5	12	39	70	1
60120011	016061	11	25	18,5	12	39	71	1
60120012	016078	12	25	20,0	12	39	72	1
W 60120013	016085	13	25	21,0	12	39	74	1
W 60120014	016092	14	25	22,5	12	39	79	1
W 60120015	016108	15	30	25,0	12	39	119	1
W 60120016	016115	16	30	26,0	12	39	121	1
W 60120017	016122	17	30	26,0	13	39	122	1
W 60120018	016139	18	30	27,5	13	39	123	1
W 60120019	016146	19	30	28,0	13	39	125	1
60120020	023465	20	30	30,0	15	38	120	1
W 60120021	016153	21	30	30,0	13	39	127	1
W 60120022	016160	22	30	32,0	13	39	131	1
W 60120023	023472	23	30	32,0	14	38	123	1
W 60120024	016177	24	30	34,0	20	39	175	1
W 60120025	023489	25	30	36,0	16	43	167	1
W 60120026	023496	26	30	36,0	21	43	148	1
W 60120027	016184	27	30	38,0	24	43	225	1
W 60120028	023502	28	30	40,0	22	47	200	1
60120029	023519	29	30	40,0	22	47	195	1
60120030	016191	30	30	42,0	24	48	253	1
60120032	016207	32	30	44,0	26	48	273	1
60120033	028149	33	43	46,0	28	48	281	1
60120036	023526	36	43	50,0	25	47	362	1

6012 L 1/2" 6-POINT LONG METRIC IMPACT SOCKETS

▪ Surface: Phosphatised finish. Material: Chrome-molybdenum steel.

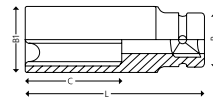

ITEM NO.	5704196+	SIZE MM	B MM	B1 MM	C MM	L MM	G	
60124010	016214	10	24	17,5	14	78	154	1
60124011	016221	11	24	18,5	14	78	163	1
60124012	016238	12	24	20,0	14	78	169	1
60124013	016245	13	24	21,0	14	78	185	1
60124014	016252	14	24	22,0	17	78	201	1
60124015	016269	15	24	24,0	17	78	213	1
60124016	016276	16	24	24,0	17	78	224	1
60124017	016283	17	26	26,0	17	78	252	1
60124018	016290	18	28	28,0	17	78	283	1
60124019	016306	19	28	28,0	19	78	268	1
60124020	023533	20	30	30,0	24	78	247	1
60124021	016313	21	30	30,0	24	78	310	1
60124022	016320	22	30	32,0	24	78	302	1
60124023	023540	23	30	32,0	26	78	256	1
60124024	016337	24	30	34,0	24	78	309	1
60124025	023557	25	30	36,0	35	78	296	1
60124026	023564	26	30	36,0	35	78	280	1
60124027	016344	27	30	38,0	24	78	325	1
60124028	023571	28	30	40,0	35	78	316	1
60124029	023588	29	30	40,0	35	78	355	1
60124030	016351	30	30	42,0	24	78	352	1
60124032	016368	32	30	44,0	24	78	317	1

6090 1/2" METRIC SOCKET WRENCH SET

ITEM NO. 60901222

- Set in watertight plastic case with 6-point impact sockets from 10 to 32 mm and accessories.
- 22 tools.

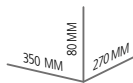

3,5 KG

5704196 016474

1

1/2"



CONTENT:

QTY.	DESCRIPTION	SIZE
15	6-point sockets	6012 1/2" 10 - 11 - 12 - 13 - 14 - 15 - 16 - 17 - 19 - 21 - 22 - 24 - 27 - 30 - 32 mm
1	Extension	6212 1/2" EX 125 mm
1	Adaptor	6638 1/2" A
1	Universal joint	6812 1/2" U
2	Safety set	6012 1/2" SR 8 - 14 mm / 15 - 32 mm



POLAR® IMPACT SOCKETS AND ACCESSORIES



6090 L 1/2" METRIC SOCKET WRENCH SET

ITEM NO. 60901220

- Set in watertight plastic case with 6-point long impact sockets from 10 to 32 mm and accessories.
- 20 tools.

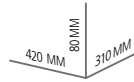

4,6 KG

5704196 016481

1

1/2"

20
TOOLS



CONTENT:

QTY.	DESCRIPTION	SIZE
15	Long 6-point sockets	6012 1/2" L 10 - 11 - 12 - 13 - 14 - 15 - 16 - 17 - 19 - 21 - 22 - 24 - 27 - 30 - 32 mm
1	Extension	6212 1/2" EX 125 mm
2	Safety set	6012 1/2" SR 8 - 14 mm / 15 - 32 mm

6012 LT 1/2" 6-POINT LONG METRIC IMPACT SOCKETS

- Model with thin walls for wheel nuts.
- Surface: Phosphatised finish. Material: Chrome-molybdenum steel.

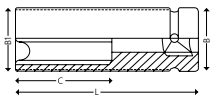

ITEM NO.		SIZE MM	B MM	B1 MM	C MM	L MM	 G	
60124115	023649	15	28	27,0	24	85	185	1
60124117	016375	17	30	24,0	24	85	240	1
60124119	016382	19	30	26,0	24	85	259	1
60124121	016399	21	30	28,0	24	85	270	1
60124122	016405	22	30	29,5	24	85	296	1
60124124	023656	24	33	31,0	24	85	303	1
60124127	023663	27	37	35,0	28	85	406	1

6090 LT 1/2" METRIC SOCKET WRENCH SET

ITEM NO. 60901204

- Set in metal box with 6-point long impact sockets with thin walls for wheel nuts.
- 6 tools.

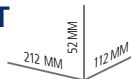

1,5 KG

5704196 016467

1

1/2"

6
TOOLS



CONTENT:

QTY.	DESCRIPTION	SIZE
4	Long thinwalled 6-point sockets	6012 1/2" LT 17 - 19 - 21 - 22 mm
1	Safety set	6012 1/2" SR 15 - 32 mm



POLAR® IMPACT SOCKETS AND ACCESSORIES

6112 TW 1/2" METRIC IMPACT SOCKETS

ISO 1174, DIN 3120

- Twist sockets for removal rounded or damaged fasteners with almost any head configuration.
- Surface: Phosphatised finish.
- Material: Chrome-molybdenum steel.

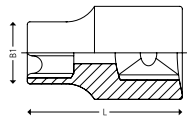

ITEM NO.	5704196+	SIZE MM	B1 MM	L MM	G	
61125010	025476	10	16,0	34	43	1
61125011	025483	11	18,0	34	47	1
61125012	025490	12	18,5	34	49	1
61125013	025506	13	20,5	34	53	1
61125014	025513	14	22,0	34	70	1
61125015	025520	15	22,4	34	70	1
61125016	025537	16	23,5	34	71	1
61125017	025544	17	25,5	34	81	1
61125018	025551	18	26,5	34	91	1
61125019	025568	19	27,5	34	93	1
61125021	025575	21	29,5	34	94	1
61125024	025582	24	33,0	34	112	1
61125027	025599	27	37,0	34	116	1

6112 TB 1/2" IMPACT TORSION BARS

ISO 1174, DIN 3120

- Surface: Phosphatised finish. Material: Chrome-molybdenum steel.

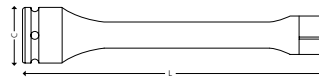

ITEM NO.	5704196+	MAX. Nm	C MM	L MM	G	
61126090	025681	90	25	200	172	1
61126100	025698	100	25	200	215	1
61126120	025704	120	25	200	200	1
61126135	025711	135	25	200	214	1
61126150	025728	150	25	200	259	1

6190 TW 1/2" TWIST IMPACT SOCKET SET

ITEM NO. 6190-5013

- Set in metal box with twist impact sockets from 10 to 27 mm.
- 13 tools.

1/2"

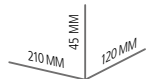

1,7 KG

5704196 025759



CONTENT:

QTY.	DESCRIPTION	SIZE
13	Twist impact sockets	6112 1/2" TW 10 - 11 - 12 - 13 - 14 - 15 - 16 - 17 - 18 - 19 - 21 - 24 - 27 mm

POLAR® IMPACT SOCKETS AND ACCESSORIES



6112 TBS 1/2" TORSION BARS WITH HEX SOCKET

- Surface: Phosphatised finish. Material: Chrome-molybdenum steel.

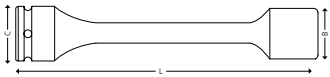

ITEM NO.	5704196+	CAPACITY NM	SIZE MM	B MM	C MM	L MM	⚖️ G
61126170	027913	90	17	26	25	200	216
61126171	027920	120	17	26	25	200	244
61126191	027937	90	19	28	25	200	219
61126192	027944	120	19	28	25	200	247
61126193	027951	135	19	28	25	200	261
61126210	027968	120	21	30	25	200	251
61126220	027975	135	21	32	25	200	267

6190 1/2" IMPACT TORSION BAR SET

- Supplied in nylon bag.

**16
SIZES IN
ONE SET**

**8
TOOLS**



6112 H 1/2" IMPACT SOCKET DRIVERS, HEX HEAD SCREWS

- Surface: Phosphatised finish. Material: Chrome-molybdenum steel.



ITEM NO.	5704196+	SIZE MM	C MM	L MM	⚖️ G	📦
61122005	023670	5	25	78	96	1
61122006	023687	6	25	78	97	1
61122008	023694	8	25	78	102	1
61122010	023700	10	25	78	108	1
61122012	023717	12	25	78	125	1
61122014	023724	14	25	78	145	1
61122017	023731	17	25	78	182	1
61122019	023748	19	25	78	210	1

5704196+	QTY.	DESCRIPTION	SIZE	⚖️ KG
027661	4	Impact sockets	6112 TB 17 - 19 - 21 - 22 mm	1,3
	4	Impact torsion bars	6012 90 - 100 - 120 - 135 Nm	

6190 H 1/2" IMPACT SOCKET DRIVER SET FOR 6-POINT SCREWS

- Set in metal box with impact socket drivers for 6-point screws from 5 to 19 mm

- 8 tools.

1/2"

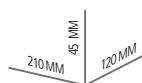

1,8 KG

5704196 025742

CONTENT:

QTY.	DESCRIPTION	SIZE
8	Impact socket drivers	6112 1/2" H 5 - 6 - 8 - 10 - 12 - 14 - 17 - 19 mm



**8
TOOLS**



POLAR® IMPACT SOCKETS AND ACCESSORIES

6112 TX 1/2" IMPACT SOCKET DRIVERS, TORX® SCREWS

▪ Surface: Phosphatised finish. Material: Chrome-molybdenum steel.



ITEM NO.	5704196+	TORX® NO.	MM	C MM	L MM	G	
61121030	023755	T30	5,52	25	78	77	1
61121040	023762	T40	6,65	25	78	81	1
61121045	023779	T45	7,82	25	78	85	1
61121050	023786	T50	8,83	25	78	89	1
61121055	023793	T55	11,22	25	78	107	1
61121060	023809	T60	13,25	25	78	119	1

6112 X 1/2" IMPACT SOCKET DRIVERS, XZN® SCREWS

▪ Surface: Phosphatised finish. Material: Chrome-molybdenum steel.



ITEM NO.	5704196+	SIZE	C MM	L MM	G	
61124005	023816	M5	25	78	79	1
61124006	023823	M6	25	78	83	1
61124008	023830	M8	25	78	84	1
61124010	023847	M10	25	78	100	1
61124012	023854	M10	25	78	105	1
61124014	023861	M14	25	78	117	1
61124016	023878	M16	25	78	136	1

6190 TX 1/2" IMPACT SOCKET DRIVER SET FOR TORX® SCREWS

- Set in metal box with impact socket drivers for Torx® screws from T30 to T60.
- 6 tools.

1/2"

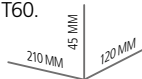

1,3 KG

5704196 025735

CONTENT:

QTY.	DESCRIPTION	SIZE
6	Impact socket drivers	6112 1/2" TX T30 - T40 - T45 - T50 - T55 - T60



6 TOOLS

6190 XZN 1/2" IMPACT SOCKET DRIVER SET FOR XZN® SCREWS

- Set in metal box with impact socket drivers for XZN® screws from 5 to 16 mm.
- 7 tools.

1/2"

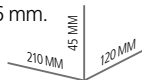

1,4 KG

5704196 027906

CONTENT:

QTY.	DESCRIPTION	SIZE
7	Impact socket drivers	6112 1/2" XZN 5 - 6 - 8 - 10 - 12 - 14 - 16 mm



7 TOOLS

POLAR® IMPACT SOCKETS AND ACCESSORIES



6212 EX 1/2" EXTENSIONS

▪ Surface: Phosphatised finish. Material: Chrome-molybdenum steel.



ITEM NO.	5704196+	L MM	A MM	G	
62120075	016443	75	24	138	1
62120125	016450	125	24	215	1

6812 U 1/2" UNIVERSAL JOINT

▪ Surface: Phosphatised finish. Material: Chrome-molybdenum steel.



ITEM NO.	5704196+	L MM	A MM	G	
68120012	016436	65	28	205	1

6612 A 1/2" ADAPTOR FROM 1/2" TO 3/4"

▪ Surface: Phosphatised finish. Material: Chrome-molybdenum steel.



ITEM NO.	5704196+			A MM	L MM	G	
66121234	024219	1/2"	3/4"	30	48	165	1

6012 SR 1/2" SAFETY SET

▪ Includes safety ring and pin.



ITEM NO.	5704196+	SIZE	G	
60129301	016498	6012 1/2" 8 - 14 mm	3	1
60129302	016504	6012 1/2" 15 - 32 mm	4	1

6712 A 1/2" ADAPTOR FROM 1/2" TO 3/8"

▪ Surface: Phosphatised finish. Material: Chrome-molybdenum steel.



ITEM NO.	5704196+			A MM	L MM	G	
67121238	023601	1/2"	3/8"	25	38	60	1



POLAR® IMPACT SOCKETS AND ACCESSORIES

3/4" IMPACT SOCKETS AND ACCESSORIES

6034 3/4" 6-POINT METRIC IMPACT SOCKETS

ISO 2725-2, DIN 3129

▪ Surface: Phosphatised finish. Material: Chrome-molybdenum steel.

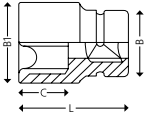

ITEM NO.	5704196+	SIZE MM	B MM	B1 MM	C MM	L MM	G	
60340017	023885	17	38	30,0	17	51	230	1
60340019	023908	19	38	32,0	18	52	240	1
60340021	023922	21	38	35,0	18	52	258	1
60340022	023939	22	38	35,0	18	52	258	1
60340024	023953	24	38	38,0	18	52	273	1
60340027	023984	27	40	40,0	28	52	283	1
60340028	023991	28	40	40,0	28	52	271	1
60340029	028583	29	42	42	28	52	287	1
60340030	024004	30	44	44,0	28	52	360	1
60340032	024011	32	44	48,0	31	56	443	1
60340033	024028	33	44	48,0	32	56	420	1
60340034	024035	34	44	52,0	29	56	490	1
60340036	024042	36	44	52,0	32	56	465	1
60340038	024059	38	44	56,0	32	56	530	1
60340041	024066	41	44	60,0	28	56	575	1
60340046	024073	46	44	67,0	28	61	720	1
60340050	024080	50	54	71,0	42	72	1050	1
60340055	024097	55	54	77,0	40	74	1220	1
60340060	024103	60	54	84,0	40	74	1385	1

6034 L 3/4" 6-POINT LONG METRIC IMPACT SOCKETS

▪ Surface: Phosphatised finish. Material: Chrome-molybdenum steel.

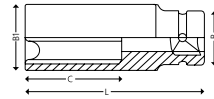

ITEM NO.	5704196+	SIZE MM	B MM	B1 MM	C MM	L MM	G	
60344022	024110	22	44	37,0	32	90	640	1
60344024	024127	24	44	39,0	36	90	655	1
60344027	024134	27	44	43,0	57	90	615	1
60344030	024141	30	44	46,0	57	90	665	1
60344032	024158	32	44	49,0	57	90	720	1
60344033	024165	33	44	51,0	57	90	760	1
60344036	024172	36	44	54,0	57	90	830	1
60344041	024189	41	44	60,0	57	92	935	1

6090 3/4" METRIC SOCKET WRENCH SET

▪ Set in watertight plastic case with 6-point impact sockets from 22 to 36 mm.

▪ 10 tools.

3/4"

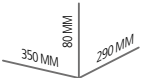

5704196 025766 4,4 KG

CONTENT:

QTY.	DESCRIPTION	SIZE
10	6-point impact sockets	6034 3/4" 22 - 24 - 27 - 28 - 29 - 30 - 32 - 33 - 34 - 36 mm

10
TOOLS



POLAR® IMPACT SOCKETS AND ACCESSORIES



6034 LT 3/4" 6-POINT LONG METRIC IMPACT SOCKETS

- Model with thin walls for wheel nuts.
- Surface: Phosphatised finish. Material: Chrome-molybdenun steel.

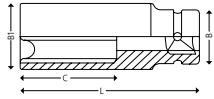

ITEM NO.	5704196+	SIZE MM	B MM	B1 MM	C MM	L MM	G	
60344119	024240	19	44	29,0	41	90	550	1
60344122	024257	22	44	34,0	35	90	585	1
60344124	024264	24	44	37,0	37	90	620	1
60344127	024271	27	44	41,0	60	90	575	1
60344130	024288	30	44	44,0	56	90	575	1
60344132	024295	32	44	47,0	56	90	635	1
60344133	024301	33	44	48,0	56	90	655	1
60344136	024318	36	44	52,0	53	90	735	1

6634 A 3/4" ADAPTOR FROM 3/4" TO 1"

- Surface: Phosphatised finish. Material: Chrome-molybdenum steel.

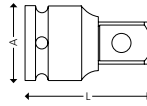

ITEM NO.	5704196+			A MM	L MM	G	
66343401	024677	3/4"	1"	44	63	430	1

6734 A 3/4" ADAPTOR FROM 3/4" TO 1/2"

- Surface: Phosphatised finish. Material: Chrome-molybdenum steel.

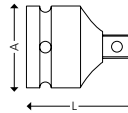

ITEM NO.	5704196+			A MM	L MM	G	
67343412	016412	3/4"	1/2"	44	56	305	1

6134 H 3/4" IMPACT SOCKET DRIVERS, HEX HEAD SCREWS

- Surface: Phosphatised finish.
- Material: Chrome-molybdenum steel.

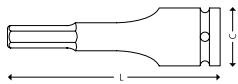

ITEM NO.	5704196+	SIZE MM	C MM	L MM	G	
61342017	029375	17	44	89	445	1
61342019	029382	19	44	89	506	1
61342020	029399	20	44	89	488	1
61342021	029405	21	44	89	534	1
61342022	029412	22	44	89	548	1
61342024	029429	24	44	89	586	1

6834 U 3/4" UNIVERSAL JOINT

- Surface: Phosphatised finish. Material: Chrome-molybdenum steel.

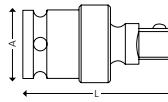

ITEM NO.	5704196+	L MM	A MM	G	
68340034	024233	90	44	650	1

6234 EX 3/4" EXTENSIONS

- Surface: Phosphatised finish. Material: Chrome-molybdenum steel.

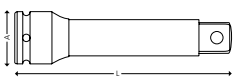

ITEM NO.	5704196+	L MM	A MM	G	
62340100	024196	100	44	560	1
62340250	024202	250	44	1110	1

6034 SR 3/4" SAFETY SET

- Includes safety ring and pin.



ITEM NO.	5704196+	SIZE	G	
60349301	030227	6034 3/4" 17 - 49 mm	7	1
60349302	030234	6034 3/4" 50 - 70 mm	9	1



POLAR® IMPACT SOCKETS AND ACCESSORIES

1" IMPACT SOCKETS AND ACCESSORIES

6001 1" 6-POINT METRIC IMPACT SOCKETS

ISO 2725-2, DIN 3129

- Surface: Phosphatised finish.
- Material: Chrome-molybdenum steel.

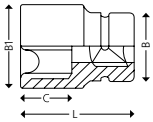

ITEM NO.	5704196+	SIZE MM	B MM	B1 MM	C MM	L MM	G	
60010024	024325	24	54	42,0	16	58	555	1
60010027	024332	27	54	45,0	16	58	575	1
60010028	028156	28	54	47,0	16	58	590	1
60010030	024349	30	54	49,0	19	60	627	1
60010032	024356	32	54	52,0	19	60	660	1
60010033	024363	33	54	52,0	19	61	675	1
60010034	028163	34	54	54,0	22	61	692	1
60010035	028170	35	54	56,0	25	61	725	1
60010036	024387	36	54	57,0	27	65	740	1
60010038	028187	38	54	60,0	27	65	775	1
60010041	024394	41	54	63,0	27	65	835	1
60010046	024400	46	54	69,0	32	74	1090	1
60010050	024417	50	54	74,0	32	74	1215	1
60010055	024424	55	54	80,0	42	85	1530	1
60010060	024431	60	54	87,0	46	90	1810	1
60010065	024448	65	54	93,0	46	93	2065	1
60010070	024455	70	54	100,0	52	98	2320	1

6001 L 1" 6-POINT LONG METRIC IMPACT SOCKETS

- Surface: Phosphatised finish. Material: Chrome-molybdenum steel.

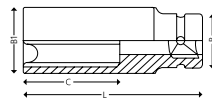

ITEM NO.	5704196+	SIZE MM	B MM	B1 MM	C MM	L MM	G	
60014024	024462	24	54	42,0	38	90	880	1
60014027	024479	27	54	45,0	40	90	905	1
60014030	024486	30	54	50,0	42	90	955	1
60014032	024493	32	54	52,0	43	90	975	1
60014033	024509	33	54	53,0	41	90	1000	1
60014036	024523	36	54	57,0	53	90	1010	1
60014041	024530	41	54	63,0	50	90	1170	1
60014046	024547	46	54	69,0	64	100	1485	1
60014050	024554	50	54	74,0	57	100	1645	1
60014055	024561	55	54	81,0	48	100	1800	1
60014060	024578	60	54	87,0	75	120	2450	1
60014065	024585	65	54	93,0	78	120	2500	1
60014070	024592	70	54	98,0	81	125	3050	1

6001 LT 1" 6-POINT LONG METRIC IMPACT SOCKETS

- Model with thin walls for wheel nuts.
- Surface: Phosphatised finish. Material: Chrome-molybdenum steel.

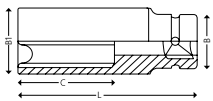

ITEM NO.	5704196+	SIZE MM	B MM	B1 MM	C MM	L MM	G	
60014127	024608	27	54	42,0	42	90	830	1
60014130	024615	30	54	45,0	49	90	810	1
60014132	024622	32	54	47,0	41	90	850	1
60014133	024639	33	54	49,0	42	90	895	1
60014136	024646	36	54	52,0	52	90	820	1

6001 SR 1" SAFETY SET

- Includes safety ring and pin.



ITEM NO.	5704196+	SIZE	G	
60019301	030241	6001 1" 17 - 70 mm	15	1

6090 1" METRIC SOCKET WRENCH SET

- Set in watertight plastic case with 6-point impact sockets from 24 to 46 mm.
- 8 tools.



CONTENT:

QTY.	DESCRIPTION	SIZE
8	6-point impact sockets	6001 1" 24 - 27 - 30 - 32 - 33 - 36 - 41 - 46 mm

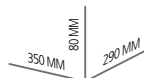

6,6 KG

5704196 028057



POLAR® IMPACT SOCKETS AND ACCESSORIES



1 1/2" IMPACT SOCKETS AND ACCESSORIES

6201 EX 1" EXTENSIONS

▪ Surface: Phosphatised finish. Material: Chrome-molybdenum steel.



ITEM NO.	5704196+	L MM	A MM	G	1
62010175	024653	175	54	1410	1
62010325	024660	325	54	2400	1

6701 A 1" ADAPTOR FROM 1" TO 3/4"

▪ Surface: Phosphatised finish. Material: Chrome-molybdenum steel.



ITEM NO.	5704196+	1"	3/4"	A MM	L MM	G	1
67010134	024226	1"	3/4"	54	72	610	1

6601 A 1" ADAPTOR FROM 1" TO 1 1/2"

▪ Surface: Phosphatised finish. Material: Chrome-molybdenum steel.



ITEM NO.	5704196+	1"	1 1/2"	A MM	L MM	G	1
66010115	024868	1"	1 1/2"	54	90	1065	1

6801 U 1" UNIVERSAL JOINT

▪ Surface: Phosphatised finish. Material: Chrome-molybdenum steel.



ITEM NO.	5704196+	L MM	A MM	G	1
68010001	024691	110	54	1320	1

6015 1 1/2" 6-POINT METRIC IMPACT SOCKETS

ISO 2725-2, DIN 3129

▪ Surface: Phosphatised finish. Material: Chrome-molybdenum steel.



ITEM NO.	5704196+	SIZE MM	B MM	B1 MM	C MM	L MM	G	1
60150046	024707	46	86	74,0	29	84	2200	1
60150050	024714	50	86	79,0	35	84	2150	1
60150055	024721	55	86	86,0	35	90	2500	1
60150060	024738	60	86	92,0	43	90	2550	1
60150065	024745	65	86	98,0	45	95	2900	1
60150070	024752	70	86	104,0	47	100	3250	1
60150075	024769	75	86	110,0	48	110	4050	1
60150080	024776	80	86	116,0	54	110	4100	1
60150085	024783	85	86	122,0	54	110	4400	1
60150090	024790	90	86	130,0	57	112	4950	1
60150095	024806	95	95	135,0	62	112	5150	1
60150100	024813	100	95	140,0	58	115	5800	1
60150105	024820	105	95	148,0	65	120	6350	1
60150110	024837	110	95	154,0	70	125	7300	1
60150115	024844	115	95	160,0	65	130	7800	1
60150120	024851	120	127	165,0	67	135	11950	1

6715 A 1 1/2" ADAPTOR FROM 1 1/2" TO 1"

▪ Surface: Phosphatised finish. Material: Chrome-molybdenum steel.



ITEM NO.	5704196+	1 1/2"	1"	A MM	L MM	G	1
67151501	024684	1 1/2"	1"	86	100	1865	1

6015 SR 1 1/2" SAFETY SET

▪ Includes safety ring and pin.

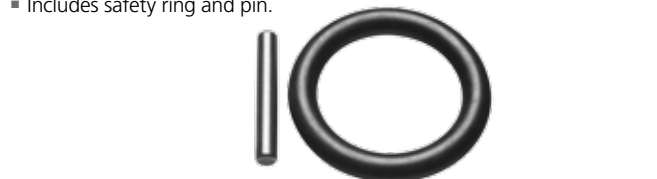

ITEM NO.	5704196+	SIZE	G	1
60159301	030265	6015 1 1/2" 30 - 90 mm	37	1
60159302	030395	6015 1 1/2" 95 - 115 mm	37	1
60159303	030401	6015 1 1/2" 120 - 155 mm	48	1



POLAR® STRIKING TOOLS



Precision heat
treatment



HAMMERS

POLAR® offers a wide range of striking tools made of carbon steel and high grade chrome-molybdenum steel. Precision heat treatment and the carefully machined parts are made for optimum performance and to enhance your safety.

- Ball pein hammers
- Claw hammers
- Mechanics hammers
- Sledge hammers
- Dead-blow hammers
- Engineers sledge hammers
- Pin punches
- Taper punches
- Center punches
- Cape chisels
- Flat chisels
- Wood chisels





8010 BALL PEIN HAMMERS

ISO 15601

- Model with round flat head and ball shaped pein. Hickory handle.
- Surface: Polished and enamelled. Material: Forged carbon steel head.



ITEM NO.	5704196+	GRAMS	OZ	A MM	B MM	C MM	L MM	G	IMPA CODE
80100230	009094	225	8	27	24	82	295	355	6 612502
80100340	009100	340	12	31	25	94	297	495	6 612503
80100450	009117	450	16	33	30	104	344	645	6 612504
80100680	009124	675	24	36	31	121	397	940	6 612506
80100900	009131	900	32	40	34	127	397	1280	6 612507

8020 F CLAW HAMMER

- Model with round flat head and curved claw.
- Fiberglass shaft with rubber handle.
- Surface: Polished and enamelled. Material: Forged carbon steel head.



ITEM NO.	5704196+	GRAMS	OZ	A MM	B MM	L MM	G
80202450	009087	450	16	30	127	337	760 6

8020 T CLAW HAMMER

- Round flat head and curved claw. Tubular steel shaft with rubber handle.
- Surface: Polished and enamelled. Material: Forged carbon steel head.

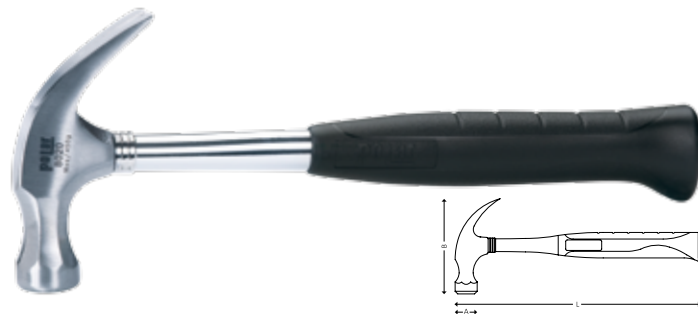

ITEM NO.	5704196+	GRAMS	OZ	A MM	B MM	L MM	G	IMPA CODE
80200450	009063	450	16	30	127	325	765 6	612607

8030 MECHANICS HAMMERS

ISO 15601, DIN 1041

- Model with Hickory handle and steel protection.
- Surface: Polished and enamelled. Material: Forged carbon steel head.



ITEM NO.	5704196+	GRAMS	A MM	B MM	L MM	G
80300100	009162	100	15	82	260	173 10
80300200	012964	200	19	95	280	271 10
80300300	009148	300	23	105	300	448 10
80300500	009155	500	27	118	320	652 10
80300800	012971	800	33	130	350	1054 10
80301000	012988	1000	34	134	360	1228 4
80301500	012995	1500	43	147	380	1847 4
80302000	013008	2000	45	155	400	2112 1

8020 S CLAW HAMMER

- Model with round flat head and curved claw.
- "One Piece" steel shaft with rubber handle.
- Surface: Polished and enamelled. Material: Forged carbon steel head and shaft.



ITEM NO.	5704196+	GRAMS	OZ	A MM	B MM	L MM	G	IMPA CODE
80201450	009070	450	16	30	127	330	760 6	





POLAR®

8040 SLEDGE HAMMERS

ISO 15601, DIN 6475

- Model with Hickory handle and steel protection.
- Surface: Polished and enamelled. Material: Forged carbon steel head.

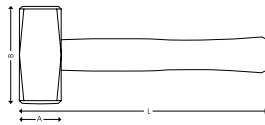

ITEM NO.	5704196+	GRAMS	A MM	B MM	L MM	G G	IMPA CODE
80401000	009001	1000	40	95	260	1233	6 612521
80401250	009018	1250	43	100	260	1375	6 612522
80401500	009025	1500	45	110	275	1642	4 612523
80402000	009032	2000	50	120	300	2327	4 612524

8060 DEAD-BLOW HAMMERS

- Model with head and shaft covered by urethane.
- Dead-blow hammer filled with steelshots. PVC handgrip.

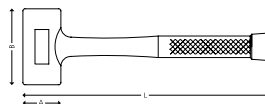

ITEM NO.	5704196+	A MM	B MM	L MM	G G	IMPA CODE
80600030	009179	35	90	280	400	12
80600040	009186	45	90	300	580	6
80600050	009193	55	110	355	1050	6

8070 ENGINEERS SLEDGE HAMMERS

- Surface: Polished and enamelled. Material: Forged carbon steel head.



ITEM NO.	5704196+	GRAMS	A MM	B MM	L MM	G G	IMPA CODE
80703000	013015	3000	55	160	600	3500	4 612565
80704000	013022	4000	65	170	700	4500	4 612566
80705000	013039	5000	70	180	800	5700	2 612568





PUNCHES & CHISELS

POLAR® Chisels are manufactured of high grade chrome-molybdenum steel and differentially heat treated for optimum performance. The hardness of the striking head is reduced to help toughness.

Differentially heat treated for optimum performance

Chrome-molybdenum steel

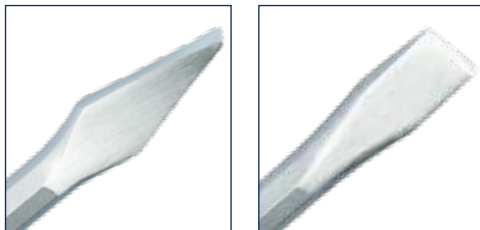

PUNCHES AND CHISELS

8200 PIN PUNCHES

DIN 6450

■ Surface: Chrome plated finish. Material: Chrome-molybdenum steel.

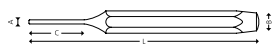

ITEM NO.	5704196+	A MM	B MM	C MM	L MM	G G	IMPA CODE
82000002	009209	2	8	23	115	34	25 613070
82000003	009216	3	8	32	125	35	25 613071
82000004	009223	4	10	35	150	64	25 613072
82000005	009230	5	10	43	165	72	25 613073
82000006	009247	6	13	47	180	136	25 613074
82000008	009254	8	13	50	180	146	25 613076

8290 PP/6 ASSORTMENT WITH 6 PIN PUNCHES

■ Supplied in nylon bag.

6 TOOLS



ITEM NO.	5704196+	QTY.	SIZE MM	G	IMPA CODE
82900006	000886	6	2-3-4-5-6-8 mm	545	1 613080
P82900006	017075	1	Empty pouch for 8290-0006	52	1



POLAR® STRIKING TOOLS

8205 TAPER PUNCHES

DIN 6458

- Surface: Chrome plated finish. Material: Chrome-molybdenum steel.

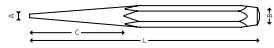

ITEM NO.	5704196+	A MM	B MM	C MM	L MM	⚖️ G	📦
82050002	009278	2	10	48	120	52	25
82050003	009285	3	10	48	120	53	25
82050004	009292	4	10	48	120	55	25
82050005	009308	5	10	48	120	58	25
82050006	009315	6	10	48	120	59	25

8215 CAPE CHISELS

DIN 6451

- Surface: Chrome plated finish. Material: Chrome-molybdenum steel.

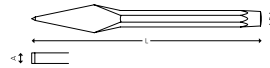

ITEM NO.	5704196+	A MM	B MM	L MM	⚖️ G	📦	IMPA CODE
82150005	009346	5	10	130	63	25	612912
82150007	009353	7	13	165	147	25	612914

8290 TP/5 ASSORTMENT WITH 5 TAPER PUNCHES

- Supplied in nylon bag.

5
TOOLS



ITEM NO.	5704196+	QTY.	SIZE MM	⚖️ G	📦
82900005	000893	5	2 - 3 - 4 - 5 - 6 mm	315	1
P82900005	017068	1	Empty pouch for 8290-0005	47	1

8220 FLAT CHISELS

DIN 6453

- Surface: Chrome plated finish. Material: Chrome-molybdenum steel.

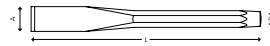

ITEM NO.	5704196+	A MM	B MM	L MM	⚖️ G	📦	IMPA CODE
82200012	009360	12	10	130	68	25	612903
82200018	009384	18	13	165	158	10	612905

8290 S/17 ASSORTMENT WITH 17 TOOLS

- Supplied with metal holder.
- Content:
 - 2 Center punches: 3 - 4 mm
 - 5 Taper punches: 2 - 3 - 4 - 5 - 6 mm
 - 6 Pin punches: 2 - 3 - 4 - 5 - 6 - 8 mm
 - 2 Flat chisels: 12 - 18 mm
 - 2 Cape chisels: 5 - 7 mm



17
TOOLS



8210 CENTER PUNCHES

DIN 7250

- Surface: Chrome plated finish. Material: Chrome-molybdenum steel.



ITEM NO.	5704196+	A MM	B MM	C MM	L MM	⚖️ G	📦	IMPA CODE
82100001	009322	3	8	40	100	32	10	613060
82100002	009339	4	10	50	120	54	10	613061

ITEM NO.	5704196+	KG	📦	IMPA CODE
82900017	000916	1,6	1	613089



8290 S/5 ASSORTMENT WITH 5 TOOLS

- Supplied in nylon bag.
- Content:
 - 1 Taper punch: 3 x 120 mm
 - 1 Center punch: 2 x 120 mm
 - 1 Cape chisel: 5 x 130 mm
 - 1 Flat chisel: 12 x 130 mm
 - 1 Pin punch: 4 x 150 mm



ITEM NO. 5704196+

82901005 000909

P82901005 017082 Empty pouch for 8290-1005

G 350 1 613088
53 1

WOOD CHISELS

8300 WOOD CHISEL

- Allround wood chisel with good durability.
- Precisioncut blade for maximum sharpness.
- Hardened for high strength and long usage.
- Softgrip handle with steel cap.
- Surface: Chrome plated finish. Material: Chrome-molybdenum steel.

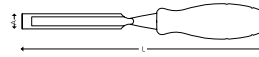

ITEM NO.	5704196+	L MM	A MM	G	IMPA CODE
83000010	009407	285	10	205	6 613612
83000013	009414	285	13	215	6 613613
83000016	009421	285	16	225	6 613614
83000019	009438	285	19	240	6 613615
83000022	209445	290	22	250	6
83000025	009452	290	25	260	6 613616
83000032	009469	320	32	315	6 613617



8390 WOOD CHISEL SET

- Supplied in plastic holder.



ITEM NO.	5704196+	QTY.	SIZE MM	G	IMPA CODE
83900003	013091	3	13 - 19 - 25 mm	775	1

MISCELLANEOUS PRODUCTS

POLAR® offers a variety of products, including measuring tools, knives, saws, vices, pullers, cable ties and lamps.

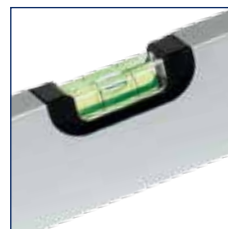
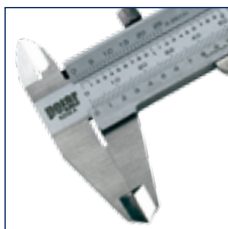

POLAR® MISCELLANEOUS PRODUCTS



8305 SCRAPER, STRAIGHT - 32 MM

- Straight model.
- Durable stainless steel blade. Ergonomic antislip bimaterial grip.
- Steel dome on the rear.

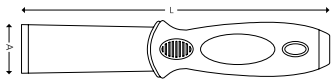

ITEM NO.	5704196+	A MM	L MM	G	
83050032	028095	32	203	114	1

8305 SCRAPER, STRAIGHT - 75 MM

- Straight model.
- Durable stainless steel blade. Ergonomic antislip bimaterial grip.
- Steel dome on the rear.

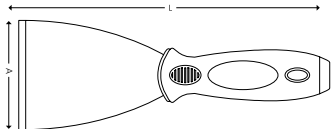

ITEM NO.	5704196+	A MM	L MM	G	
83050075	028118	75	217	157	1

8305 SCRAPER, BENT - 32 MM

- Bent model.
- Durable stainless steel blade. Ergonomic antislip bimaterial grip.
- Steel dome on the rear.

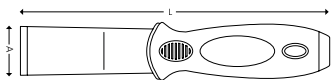

ITEM NO.	5704196+	A MM	L MM	G	
83051032	028101	32	201	114	1

8395 SET OF 3 SCRAPERS

- Supplied in nylon bag.
- Content: 1 scraper, straight (8305) 32 mm
1 scraper, straight (8305) 75 mm
1 scraper, bent (8305) 32 mm



3
TOOLS

ITEM NO.	5704196+	G	
83950003	028125	485	1

8610 OIL FILTER STRAP WRENCHES

- Material: Chrome-vanadium steel.

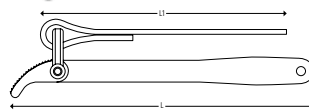

ITEM NO.	5704196+	CAPACITY MM	L MM	L1 MM	G	
86100225	028422	25-160	225	585	375	10
86100300	028439	60-260	300	840	594	10
86101225	028446	Strap (225 mm)			108	1
86101300	028453	Strap (300 mm)			129	1

POLAR® MISCELLANEOUS PRODUCTS

8400 BENCH VISES

- Model made of cast carbon steel with anvil.
- Equipped with pipe jaws. Replacable top jaws.
- Surface: Black hammer paint.
- Model 8400-0075 is supplied with swivel base.

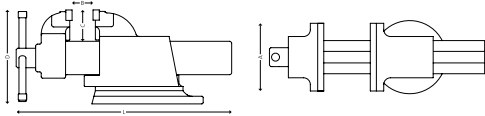

ITEM NO.	5704196+	A	B	C	D	L	KG	IMPA
		MM	MM	MM	MM	MM		CODE
84000075	009940	75	95	50	135	280	4,5	613786
84000100	009476	100	95	70	125	315	7,3	613774
84000125	009483	125	145	80	150	410	10,7	613776
84000150	009490	150	167	100	175	465	17,0	613777
84000175	020037	175	215	117	210	530	25,0	613778

8400 360° SWIVEL BASE FOR BENCH VISE

- Surface: Black hammer paint.



ITEM NO.	5704196+	KG	IMPA
84001100	020044	0,8	1
84001125	020051	1,0	1
84001150	020068	1,6	1
84001175	020075	1,9	1

8450 UNIVERSAL PULLERS

- Internal and external model with fixture for use with 2 or 3 legs.
- Spindle made of carbon steel.
- Surface: Chrome plated finish.
- Material: Chrome-vanadium steel.

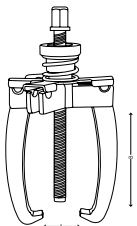

ITEM NO.	5704196+	A	B	C	D	MAX. TORQUE	KG
		MM	MM	MM	MM	NM	
84500102	017365	102	106	15	210	17 mm	90 Nm
84500178	017372	175	220	22	300	19 mm	210 Nm



POLAR® MISCELLANEOUS PRODUCTS



9000 MAGNETIC TELESCOPIC PICK-UP TOOLS

- Perfect for retrieval of ferrous objects, which are difficult to reach. Pocket clip.
- Surface: Chrome plated finish.

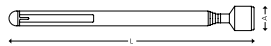

ITEM NO.	5704196+	MAX. CAPACITY KG	A MM	L MM	G	
90000016	007564	1,6	11	130-645	35	25
90000022	007571	2,2	13	135-650	40	25

9000 MAGNETIC PICK-UP TOOL - ANTI-MAGNETIC HEAD

- Perfect for retrieval of ferrous objects, which are difficult to reach.
- With pocket clip.
- Surface: Chrome plated finish.

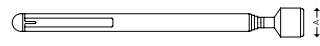

5704196+	MAX. CAPACITY KG	A MM	L MM	G	
028521	1	6,5	170 - 835	56	24
028538	2	10	175 - 835	62	24
028545	3	12	175 - 760	62	24
028552	5	13	175 - 760	64	24



9003 INSPECTION KIT

- Inspection set in protective case.
- Incl. 3 batteries
- 5 tools.

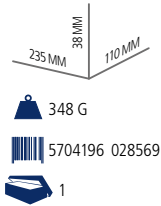

CONTENT:

QTY.	DESCRIPTION	DETAILS
1	Telescopic handle	180 - 660 mm
1	Magnet	Capacity 3,5 kg
1	LED light	White
1	Mirror, round	Ø 60 mm
1	Mirror, rektangular	42 x 64 mm



5
TOOLS



POLAR® MISCELLANEOUS PRODUCTS

9001 FLEXIBLE MAGNETIC PICK-UP TOOLS

- 500 mm aluminum shaft can be easily bent at any angle to retrieve dropped metal objects in hard to reach areas.
- Surface: Chrome plated finish.

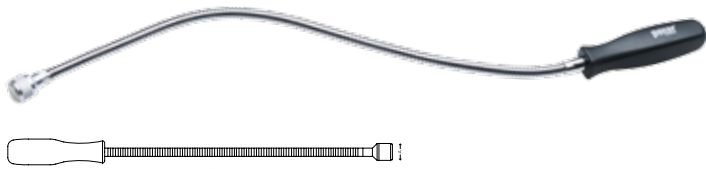

ITEM NO.	5704196+	MAX. CAPACITY KG	A MM	L MM	G	
90010001	027388	1	13	500	144	1
90010003	027395	3	17	500	154	1

9008 CLAW PICK-UP TOOL

- Claws expands to 32 mm to easily grasp the desired object.
- The 500 mm flexible shaft easily maneuvers through tight spots.
- Retractable three-clawed pincers with push-button control.
- Surface: Chrome plated finish.

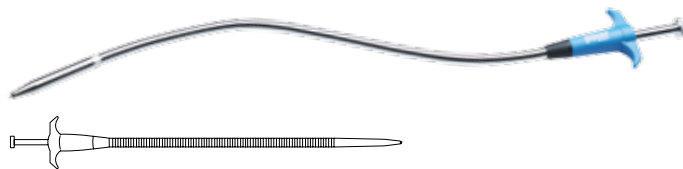

ITEM NO.	5704196+	L MM	G	
90080500	027432	500	144	1

9005 INSPECTION MIRROR

- 24 mm diameter with 5 x magnifying mirror.
- Insulated handle.
- Surface: Chrome plated finish.

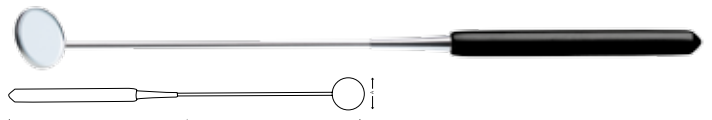

ITEM NO.	5704196+	A MM	L MM	G	
90050024	027401	24	265	26	1

9006 INSPECTION MIRROR WITH MAGNETIC PICK-UP TOOL

- 50 mm mirror diameter.
- Magnet end lifts 0.45 kg (1 lb).
- The handle extends up to 560 mm.
- Dual ball adjustment provides infinite positioning.
- With pocket clip.
- Surface: Chrome plated finish.

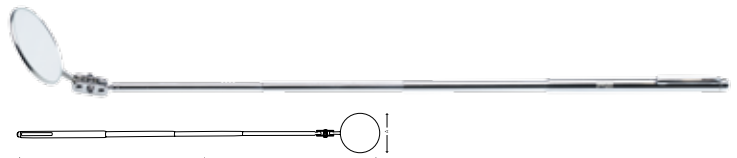

ITEM NO.	5704196+	A MM	L MM	G	
90060050	027418	50	210-560	48	1

9007 LED TELESCOPIC INSPECTION MIRROR

- 30 mm round mirror equipped with bright LED.
- The handle extends up to 665 mm.
- Dual ball adjustment provides infinite positioning.
- With pocket clip.
- Incl. 3 batteries (LR41).
- Surface: Chrome plated finish.

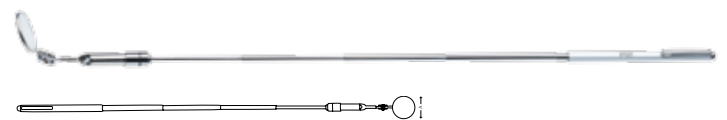



ITEM NO.	5704196+	A MM	L MM	G	
90070030	027425	30	240-665	52	1



9010 A **MAGNETIC PARTS TRAY, ROUND**

- Round stainless steel tray features powerful mounting magnet.
- Securely holds small parts and tools.
- The magnet is covered with protective rubber.
- Surface: Chrome plated finish.





ITEM NO.		Ø	H		
90100001	5704196+ 027449	MM 147	MM 25	G 328	1

9010 B **MAGNETIC PARTS TRAY, RECTANGULAR**

- Rectangular magnetic tray holds metal parts and small tools.
- Magnetically attaches to any flat iron or steel surface.
- The magnet is covered with protective rubber.
- Surface: Chrome plated finish.



ITEM NO.		SIZE	H		
90100002	5704196+ 027456	MM 240 x 140	MM 25	G 620	1



POLAR® MISCELLANEOUS PRODUCTS

KNIVES

9101 UTILITY KNIFE - 9 MM

- Professional model with 9 mm snap-off blades.
- Steel blade guide with automatic insert of new blades.
- 4 spare blades inside the handle.
- Comfortable rubber grip.



ITEM NO.	5704196+	L MM	G	IMPA CODE
91010009	008288	140	114	12 471011

9115 UTILITY KNIFE

- Model with standard blades.
- Quick change mechanism allows for easy blade removal and blade insert without opening the knife.
- Three different blade positions.
- Includes 5 extra blades inside the handle.
- Comfortable rubber grip.



ITEM NO.	5704196+	L MM	G	IMPA CODE
91150010	008332	170	215	12

9101 SB 9 MM SPARE BLADES (10 PCS.)



ITEM NO.	5704196+	SIZE MM	G	IMPA CODE
91010910	008295	9 mm	24	50 471014

9115 SB STANDARD SPARE BLADES (10 PCS.)



ITEM NO.	5704196+	SIZE MM	G	IMPA CODE
91150010	011622	60 x 19 x 0,6 mm	36	50

9105 UTILITY KNIFE - 18 MM

- Professional model with 18 mm snap-off blades.
- Steel blade guide with automatic insert of new blades.
- Adjustment screw to lock the blade.
- 4 spare blades inside the handle.
- Comfortable rubber grip.



ITEM NO.	5704196+	L MM	G	IMPA CODE
91050018	008301	170	228	12 471013

9105 SB 18 MM SPARE BLADES (10 PCS.)



ITEM NO.	5704196+	SIZE MM	G	IMPA CODE
91051810	008318	18 mm	50	36 471015



POLAR® MISCELLANEOUS PRODUCTS



SAWS

9200 M HANDSAW MAXCUT

- Professional handsaw for fine and medium thick materials and plastic tubes.
- TCT-teeth on thick blade for high precision and straight cutting with exceptionally good stability.
- Teflon coating for low-friction and rust protection.
- Ergonomic and shockabsorbing handle.
- Hardened teeth never need resharpening.
- Magnetic teeth protection.



ITEM NO.	5704196+	SIZE MM	SIZE "	TPI	G	1	IMPA CODE
92000550	008356	550	22"	11	460	1	613402

9210 J HACKSAW JUNIOR

DIN 6473

- Model for 150 mm blades with possibility of positioning the blade at 45° and 90°.
- Screw for regulating blade tension. 32 TPI steel blade. Ergonomic non-slip grip.
- Surface: Enamelled finish.



ITEM NO.	5704196+	BLADE MM	BLADE "	A MM	L MM	G	12	IMPA CODE
92100150	008370	150	6"	85	270	215	12	613424

9211 SPARE BLADE

- SK-5 steel model.



ITEM NO.	5704196+	TPI	L MM	L "	G	QTY. PCS.	1
92110001	018607	24	150	6"	6	1	1

9210 HACKSAW

DIN 6473.

- Model for 300 mm blades with possibility of positioning the blade at 45° and 90°.
- Screw for regulating blade tension. HHS bi-metal steel blade 24 TPI.
- Surface: Enamelled finish.

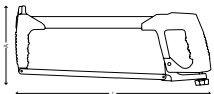

ITEM NO.	5704196+	BLADE MM	BLADE "	A MM	L MM	G	6	IMPA CODE
92100300	008363	300	12"	150	400	595	6	613428

9210 M HACKSAW

DIN 6473.

- Model for 300 mm blades with possibility of positioning the blade at 90°.
- Screw for regulating blade tension.
- HHS bi-metal steel blade 24 TPI.
- Surface: Enamelled finish.



ITEM NO.	5704196+	BLADE MM	BLADE "	A MM	L MM	G	12	IMPA CODE
92101300	018799	300	12"	130	430	380	12	613428

9210 E HACKSAW

DIN 6473.

- Model for 300 mm blades with possibility of positioning the blade at 45° and 90°.
- Blade tension regulator integrated in the handle.
- Steel body with antislip and shock resistant plastic coating.
- HHS BI-METAL steel blade 24 TPI.

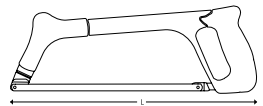

ITEM NO.	5704196+	BLADE MM	BLADE "	A MM	L MM	G	6	IMPA CODE
92102300	018805	300	12"	140	402	580	6	613428

9211 SPARE BLADES

- HSS BI-METAL steel model.



ITEM NO.	5704196+	TPI	L MM	L "	G	QTY. PCS.	1
92110002	008400	24	300	12"	17	2	1
92111010	024936	14	300	12"	17	10	1
92112010	024943	18	300	12"	17	10	1
92110010	008394	24	300	12"	17	10	1

POLAR® MISCELLANEOUS PRODUCTS

MEASURING TOOLS

9200 A VERNIER CALIPER

ISO 3599, DIN 862

- Accurate to 0.02 mm (1/50 mm). Inside, outside and depth measurements.
- Vernier with thumb positioning guide.
- Vernier screw lock. Supplied in plastic case.
- Surface: Matt chrome beam and vernier. Material: Stainless steel.

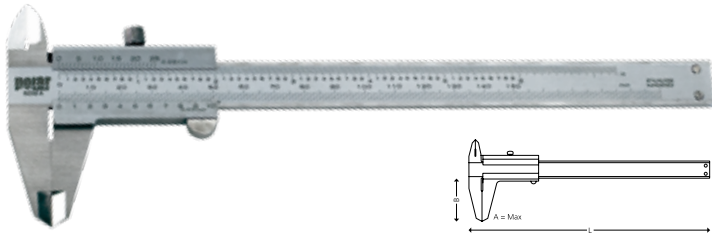

ITEM NO.	5704196+	PRECISION MM/INCH	A MM	B MM	L MM	G	IMPA CODE
92000150	009582	0.02 / 0.001	150	40	235	155	1 650511

9400 S TAPE RULES

- Precision class II. Casing in steel with rubbergrip and clip.
- Anti-reflex nylon coated tape of hardened steel.
- Corrosion-, wear- and scratching resistant. Two buttons for tape rewind.
- Rigid up to 2,4 m horizontal and 3,6 m vertical.
- Double graduation in black on yellow background.
- Decimals highlighted in red.



ITEM NO.	5704196+	L	SCALE	WIDTH MM	AxBxC MM	G	IMPA CODE
94000003	009506	3 m	mm	16	70 x 65 x 30	150	12 650821
94000005	009513	5 m	mm	25	80 x 75 x 38	300	12 650823
94000008	009520	8 m	mm	25	90 x 85 x 40	415	6

9400 P TAPE RULE

- Precision class II. Casing of shock resistant ABS with rubbergrip and stainless clip.
- Anti-reflex nylon coated tape of hardened steel.
- Corrosion-, wear- and scratching resistant. Button for tape rewind.
- Rigid up to 2,4 m horizontal and 3,6 m vertical.
- Double graduation in black on yellow background.
- Decimals highlighted in red.



ITEM NO.	5704196+	L	SCALE	WIDTH MM	AxBxC MM	G	IMPA CODE
94001005	011257	5 m	mm	25	93 x 70 x 40 mm	250	12

9400 C TAPE RULE

- Precision class II. Casing in steel with rubbergrip and clip.
- Stainless hook with two magnets. Anti-reflex nylon coated tape of hardened steel.
- Corrosion-, wear- and scratching resistant. Two buttons for tape rewind.
- Rigid up to 1,8 m horizontal and 2,6 m vertical.
- Double graduation in mm and inches, black on yellow background.
- Decimals highlighted in red.



ITEM NO.	5704196+	L	SCALE	WIDTH MM	AxBxC MM	G	IMPA CODE
94002003	017211	3 mtr/10 ft	mm/inches	16	70 x 65 x 30	135	6 650827

9410 P TAPE RULE

- Precision class II.
- Casing of shock resistant ABS with rubbergrip.
- Folding winder. Loop with retractable claw.
- Graduation in black on yellow background.
- Decimals highlighted in red.

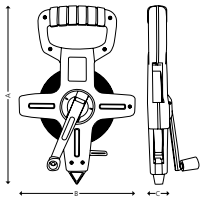

ITEM NO.	5704196+	L	SCALE	WIDTH MM	A x B x C MM	G	IMPA CODE
94100050	008387	50 m	mm / cm	12	295 x 190 x 40	965	1 650839

9500 ALUMINIUM LEVELS

- Precision $0.057^\circ = 1 \text{ mm/m}$
- Supplied with two vertical and one horizontal vial.



ITEM NO.	5704196+	L MM	A MM	B MM	G	IMPA CODE
95000400	009650	400	50	20	245	1
95000600	009667	600	50	20	338	1
95001200	009681	1200	50	20	632	1

9510 TORPEDO LEVEL WITH MAGNET

- Precision $0.057^\circ = 1 \text{ mm/m}$
- Supplied with one vertical, one horizontal and one 45° vial.

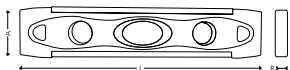

ITEM NO.	5704196+	L MM	A MM	B MM	G	IMPA CODE
95100225	009643	225	47	17	153	1



POLAR® MISCELLANEOUS PRODUCTS

CABLE TIES

9605 CABLE TIES (100 PCS.)

- UL Flame rating: 94V-2
- Material: Neutral 6/6 nylon
- Operating temperature: -40°C ~ 85°C.



ITEM NO.	5704196+	A x L MM	Ø MAX. MM	MIN. LOOP TENSILE STRENGTH KG	QTY PCS.	
96050005	017389	2,5 x 100	22	8,1	100	1
96050010	017402	2,5 x 150	36	8,1	100	1
96050015	017419	2,5 x 200	53	8,1	100	1
96050020	017426	3,6 x 140	33	18,2	100	1
96050025	017440	3,6 x 200	53	18,2	100	1
96050030	017457	3,6 x 300	76	18,2	100	1
96050035	017464	4,6 x 180	43	22,2	100	1
96050040	017488	4,8 x 200	50	22,2	100	1
96050045	017501	4,8 x 300	76	22,2	100	1
96050050	017525	4,8 x 370	102	22,2	100	1
96050053	026824	4,8 x 500	145	22,2	100	1
96050055	017532	7,6 x 250	67	54,4	100	1
96050060	017549	7,6 x 370	103	54,4	100	1
96050065	017556	7,6 x 540	159	54,4	100	1
96050070	017563	8,8 x 750	218	80,0	100	1
96050080	017587	12,4 x 650	195	114,0	100	1

9606 UV CABLE TIES (100 PCS.)

- UV weather resistant for outdoor application.
- UL Flame rating: 94V-2
- Material: Neutral 6/6 nylon
- Operating temperature: -40°C ~ 85°C.



ITEM NO.	5704196+	A x L MM	Ø MAX. MM	MIN. LOOP TENSILE STRENGTH KG	QTY PCS.		IMPA CODE
96060005	017594	2,5 x 100	22	8,1	100	1	794851
96060010	017617	2,5 x 150	36	8,1	100	1	
96060015	017624	2,5 x 200	53	8,1	100	1	
96060020	017631	3,6 x 140	33	18,2	100	1	784852
96060025	017655	3,6 x 200	53	18,2	100	1	
96060030	017662	3,6 x 300	76	18,2	100	1	
96060035	017679	4,6 x 180	43	22,2	100	1	
96060040	017693	4,8 x 200	50	22,2	100	1	794853
96060045	017716	4,8 x 300	76	22,2	100	1	794854
96060050	017730	4,8 x 370	102	22,2	100	1	794856
96060053	026831	4,8 x 500	145	22,2	100	1	
96060055	017747	7,6 x 250	67	54,4	100	1	
96060060	017754	7,6 x 370	103	54,4	100	1	
96060065	017761	7,6 x 540	159	54,4	100	1	
96060070	017778	8,8 x 750	218	80,0	100	1	
96060080	017396	12,4 x 650	195	114,0	100	1	
96060085	022000	12,4 x 1000	305	114,0	100	1	

9610 CABLE TIE MOUNTS (100 PCS.)

- Adhesive modell for cable ties up to 4,8 mm width.
- The two largest sizes can be mounted by screws.
- UL Flame rating: 94V-2
- Material: Neutral 6/6 nylon
- Operating temperature: -40°C ~ 85°C.

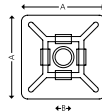

ITEM NO.	5704196+	A MM	B MM	Ø HOLE MM	QTY PCS.	
96100010	017808	19,0 x 19,0	4,0	3,6	100	1
96100015	017815	28,0 x 28,0	5,3	5,5	100	1

9611 UV CABLE TIE MOUNTS (100 PCS.)

- Adhesive modell for cable ties up to 4,8 mm width.
- The two largest sizes can be mounted by screws.
- UV weather resistant for outdoor application.
- UL Flame rating: 94V-2
- Material: Neutral 6/6 nylon
- Operating temperature: -40°C ~ 85°C.

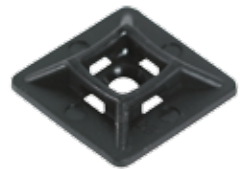
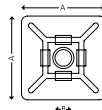

ITEM NO.	5704196+	A MM	B MM	Ø HOLE MM	QTY PCS.	
96110005	017822	12,7 x 12,7	3,2	—	100	1
96110010	017839	19,0 x 19,0	4,0	3,6	100	1
96110015	017846	28,0 x 28,0	5,3	5,5	100	1

9620 STAINLESS CABLE TIES, TYPE 316 STEEL

- Self locking ball bearing mechanism.
- Material: Stainless steel, type 316.

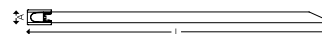

ITEM NO.	5704196+	A x L MM	Ø MAX. MM	MIN. LOOP TENSILE STRENGTH KG	QTY PCS.	
96200005	017853	4,6 x 200	62	90	100	1
96200010	017860	4,6 x 290	90	90	100	1
96200015	017877	4,6 x 360	113	90	100	1
96200020	017884	4,6 x 520	164	90	50	1
96200025	017891	4,6 x 680	215	90	50	1
96200030	017907	4,6 x 840	266	90	50	1

POLAR® MISCELLANEOUS PRODUCTS



9705 RECHARGEABLE COB LED WORK LAMP

ITEM NO. 97050001

 205 G

 5704196 016467

 1

- Powerful 270 lumen illumination.
- Strong ABS housing with IP 64 protection.
- The COB LED provides strong and smooth luminous for large area lighting.
- The torch provides intensive and focus luminous for narrow space and long distance lighting.
- Emergency function: Lamp automatically turns on if charging power is interrupted.
- Double switches to control COB and Torch luminous.
- Belt clip, Built-in Magnet and hook for easy carrying and positioning.
- Fast charging, 2.5 hrs.
- Light output: COB = 270 Lm/Torch 2500 LUX (at 0.5 m distance)
- Li-Ion Battery: 3.7V 1900 mAh
- Operating time: COB=100 min. / Torch=180 min
- Charger voltage: 180-240V AC/50-60 Hz
- Charger output: 5 V / 1A



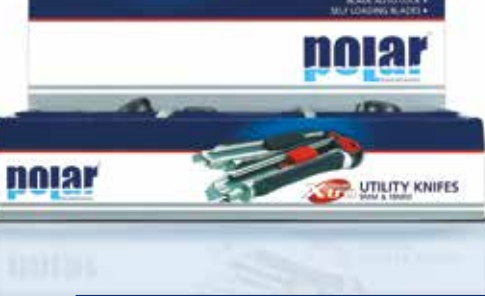

POLAR® SALES DISPLAYS

1900 D DISPLAY STAND

- Supplied with assortment of hooks and logo sign.
- Surface: Black and grey powder coating. Material: 1,2 mm sheet steel casing.



ITEM NO.	5704196+	H MM	W MM	D MM	KG	1
19000100	018645	2100	950	500	40,5	1

1905 S SHELF

- Shelf capacity: 110 kg.
- Surface: Grey powder coating. Material: 1,2 mm sheet steel casing.



ITEM NO.	5704196+	H MM	W MM	D MM	KG	1
19050101	016016	30	910	270	3,5	1

1905 F SHELF FRONT

- Material: Plexiglass



ITEM NO.	5704196+	H MM	W MM	D MM	KG	1
19050102	015484	40	905	3	0,11	1

1905 L LOGO STREAMER FOR SHELF

- For 1905 S.



ITEM NO.	5704196+	H MM	W MM	D MM	KG	1
19050103	015491	25	905	1	0,01	1

1905 L LIGHTNING

- Voltage: 220V/50Hz
- Supplied with 1,5 mtr. cable and fluorescent tube.
- Surface: Black powder coating. Material: 0,8 mm sheet steel casing.



ITEM NO.	5704196+	H MM	W MM	D MM	KG	1
19050100	015477	215	915	275	8,0	1

1910 H HOOKS

- Surface: Zinc-coated. Material: Steel



ITEM NO.	5704196+	ØxL MM	G	1
19100050	015507	3 x 50	14	1
19100100	015514	3 x 100	20	1
19100150	015521	3 x 150	25	1

1902 DISPLAY FOR AIR TOOL

- Material: Plexiglass. Supplied with fittings.

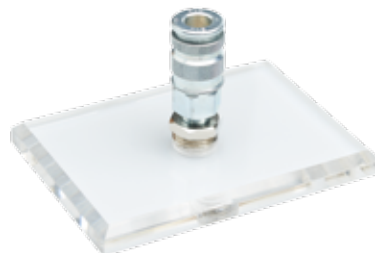

ITEM NO.	5704196+	SIZE "	G	1
19020014	027074	1/4"	310	1
19020038	027081	3/8"	310	1



1900 F DISPLAY FOR TOOL SETS

- Supplied with three hooks and logo sign.
- Surface: Black powder coating. Material: Steel structure.

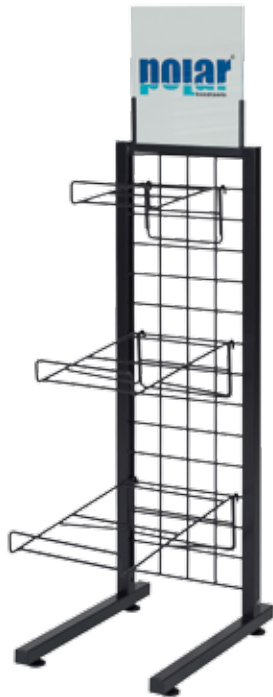

ITEM NO.	5704196+	H	W	D	KG	
		MM	MM	MM		
19000500	016009	1350	330	470	8,5	1

4590 SB/20 BITS SET

- Supplied in sales display.
- Content: 20 Bits sets, 4590 EC 1/4"



ITEM NO.	5704196+	DIMENSIONS	KG
		MM	
45902024	014876	350 x 410 x 110 mm	8,9

5090 S/20 METRIC SOCKET WRENCH SET

- Supplied in sales display.
- Content: 20 Metric socket wrench sets, 5090 1/4" HC



ITEM NO.	5704196+	DIMENSIONS	KG
		MM	
50902023	014890	350 x 410 x 110	10,1

4590 SA/20 BITS SET

- Supplied in sales display.
- Content: 20 Bits sets, 4590 A 1/4"



ITEM NO.	5704196+	DIMENSIONS	KG
		MM	
45902031	011202	345 x 255 x 105 mm	5,5



POLAR® SALES DISPLAYS

4090 S/50 SCREWDRIVER SET

ITEM NO. 40900050

- Supplied with plexiglas display.

CONTENT:

QTY.	DESCRIPTION	SIZE
5	Screwdrivers for slotted head screws	4000 3 x 75 mm
5	Screwdrivers for slotted head screws	4000 4 x 100 mm
5	Screwdrivers for slotted head screws	4000 5,5 x 125 mm
5	Screwdrivers for slotted head screws	4000 6,5 x 150 mm
5	Screwdrivers for slotted head screws	4000 8 x 175 mm
5	Screwdrivers for Phillips® head screws	4010 PH 0
5	Screwdrivers for Phillips® head screws	4010 PH 1
5	Screwdrivers for Phillips® head screws	4010 PH 2
5	Screwdrivers for Pozidriv® head screws	4020 PZ 1
5	Screwdrivers for Pozidriv® head screws	4020 PZ 2

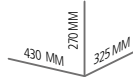

5,6 KG

5704196 013923

1



9190 S/39 UTILITY KNIVES SET

- Supplied in sales display.
- Content:
 - 27 Utility knives, 9 mm (item no. 9101)
 - 12 Utility knives, 18 mm (item no. 9105)



9490 S/24 TAPE RULES SET

- Supplied in sales display.
- Content:
 - 8 Tape Rules, 3 mtr. (item no. 9400)
 - 8 Tape Rules, 5 mtr. (item no. 9400)
 - 8 Tape Rules, 8 mtr. (item no. 9400)



ITEM NO. 5704196+

DIMENSIONS
MM

KG



91900030 027623 280 x 330 x 55 mm

6,2 1

ITEM NO. 5704196+

DIMENSIONS
MM

KG



94900024 027630 290 x 395 x 95 mm

7,4 1



POLAR COLLECTION

The POLAR® Collection covers a range of promotional products and merchandise.
We do not compromise with quality – you will always get our well known quality, also for gear and merchandise.

1005 R KNEELING MAT

- Oilproof EVA/PE foam.



ITEM NO.	5704196+	H	W	D	G	
R10051000	021911	MM	MM	MM	G	
		30	435	230	146	1

4020 POLAR MUG

- Dishwasher safe.



ITEM NO.	5704196+	G	
R40200001	026978	G	
		326	1

4000 POLAR PEN

- With pocket clip.



ITEM NO.	5704196+	G	
R40000100	026886	G	
		10	100

4000 LETTER OPENER



ITEM NO.	5704196+	G	
R40000000	026862	G	
		72	1

4000 PAPER BLOCK

- Squared paper.
- Size: 105 x 148 mm



ITEM NO.	5704196+	G	
R40000200	026893	G	
		68	5

1000 POLAR MENTOS

- Classic Mint.



ITEM NO.	5704196+	G	
R10000010	026855	G	
		2	100

POLAR® POLAR COLLECTION



4000 PLASTIC BAG



ITEM NO. 5704196+
R40000050 026879

G 18
 500

4010 POSTER

■ Including hanging rails.



ITEM NO. 5704196+
R40100005 026947

SIZE
CM
50 x 70

KG 0,5
 1

4002 STICKERS

■ Vinyl quality.



ITEM NO. 5704196+
R40020001 026909
R40020002 026916
R40020003 026923

SIZE
MM
80 x 40
50 x 120
80 x 180

G 0,7
 10
1,4 10
3,4 10

4010 ROLL UP

■ Supplied in a carrying bag.



ITEM NO. 5704196+
R40100010 026954

SIZE
CM
85 x 200

KG 4
 1

4002 FACE ADHESIVE STICKER

■ For shop windows (glue on printside for inside use)
■ Vinyl quality.



ITEM NO. 5704196+
R40020010 026930

SIZE
MM
310 x 130 mm

G 7
 1

POLAR® POLAR COLLECTION



4010 BANNER

- Outdoor PVC banner with reinforced edges.



ITEM NO.	5704196+	SIZE CM	KG	
R40100030	026961	100 x 200	5	1

4030 POLAR EXHIBITION COUNTER

- Folding exhibition counter in aluminum.
- Supplied in a carrying bag.

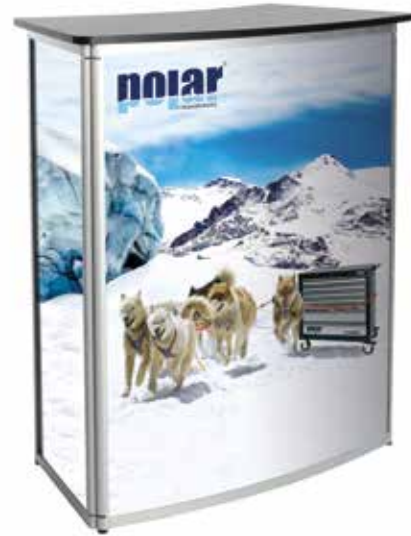

ITEM NO.	5704196+	H CM	W CM	D CM	KG	
R40300010	027005	90	80	42	10	1

4025 BEACH FLAG

- Beach flag including bag and base plate.



ITEM NO.	5704196+	SIZE CM	KG	
R40250001	026985	88 x 200	5	1

4030 POLAR TABLE DISPLAY



ITEM NO.	5704196+	SIZE MM	G	
R40300005	026992	210 x 297 (A4)	300	1



POLAR® INFORMATION



POLAR TOOLS A/S

SYMBOLS



Weight



Packaging (inner carton)



EAN code



Go-through blade



ACR profile



VDE tested, voltage with stand
strenght up to 1000 volt



Slotted



6-Point (Sockets)



Phillips®



12-Point (Sockets)



Pozidriv®



Torx® (Sockets)



Torx®



Hexagon (Bit sockets)



Tamper Resistant Torx®



Dimensions (L x H x W)



Hexagon



Square



Tools with added value

HEAD OFFICE - DENMARK

Polar Tools A/S
Soldalen 9 . 7100 Vejle . Denmark
Phone: +45 7584 1122
Mail: info@polartools.com

CUSTOMER SERVICE

Phone: +45 7584 1122
Mail: sales@polartools.com

WAREHOUSE

Polar Tools A/S
Bødkervej 2 . 7100 Vejle . Denmark
Phone: +45 7584 1122
Mail: info@polartools.com

GENERAL INFORMATION

This POLAR® catalogue cancels all previous catalogues. We reserve the right to make changes in design or construction at any time without incurring any obligation in incorporating such changes in tools or equipment previously sold. We also reserve the right to discontinue the manufacture or offering for sale through POLAR® dealers of any tools or equipment at such time as we consider necessary.

Dimensions shown in this catalogue have been rounded to the nearest fractional size or nearest tenth millimeter and are not exact product specifications. Ask your local POLAR® representative or POLAR® customer service for product specifications if required.

We cannot accept the responsibility for the results of using tools which have been abused or badly worn, such as punches and chisels mushroomed by hammer blows, or the incorrect use of tools, or tools repaired by others. The catalogue is distributed by POLAR® and all items may be available in each country. For detailed information about the availability and pricing, please contact your local POLAR® representative or POLAR® customer service.

Copyright: All text, photos and illustrations are protected by copyright. No part of this material may be reproduced without written permission from Polar Tools A/S.



POLAR® NUMERICAL CONTENT



ARTICLE PAGE

1000	29-35, 92
1005	36-38
1010	39
1011	40-41
1020	36
1025	36
1050	36-37
1055	37
1090	39
1091	47-59
1092	23-24, 46
1093	25
1100	88
1110	88
1120	89-90
1125	90
1200	92-93
1202	93
1300	91
1340	91
1345	91
1355	92
1800	60
1801	60
1802	60
1804	61
1805	61
1807	62
1808	62
1809	62
1810	63
1811	63
1812	63
1813	64
1814	64
1815	65
1816	65
1817	65
1818	65
1819	66
1820	66
1821	66
1822	66
1823	67
1824	67
1825	67
1826	67
1827	68
1828	68
1829	68-69
1830	69-70
1831	70
1832	71
1833	71
1834	71
1835	72
1836	72
1837	72
1838	72
1839	73
1840	73
1841	73
1842	74
1843	74
1844	75
1845	75

ARTICLE PAGE

1846	75
1847	75
1848	76
1849	76
1875	77-87
1900	216-217
1902	216
1905	216
1910	216
2000	95-96
2005	97
2010	97
2070	98
2090	95-96
2091	97-98
2095	97-98
2100	98
2110	99
2195	99
2200	100
2290	100
2400	100
2405	101
2490	100
2495	101
2600	102
2602	102
2610	102
2690	102
3001	113, 116
3002	113, 116
3004	113, 116
3005	113, 116
3006	113, 116
3009	113, 116
3010	117
3011	117
3020	114, 117
3024	114
3025	114
3050	114
3060	115
3061	115
3090	115
3091	117
3100	118
3105	118
3110	118
3115	118
3190	118
3200	119
3202	119
3203	119
3205	119
3210	119
3215	119
3220	120
3400	120
3500	120
3900	121
3901	121
3902	121
3903	121
3904	121
3990	121
4000	124

ARTICLE PAGE

4001	124
4002	124
4003	124
4005	124
4010	125
4011	125
4013	125
4015	124
4020	126
4021	126
4023	126
4030	130
4031	129
4035	130
4042	130
4043	130
4045	133
4090	126-130, 218
4091	127-129
4100	135
4105	135-136
4107	138
4108	138
4131	136
4137	139
4142	139
4190	136-137
4195	136-137
4197	138-139
4200	131
4202	131
4210	131
4220	131
4290	132
4400	133
4410	133
4430	133
4431	133
4490	134
4514	140-143
4516	148-149
4590	143-146, 217
4614	147
4712	149, 166
4714	148, 153
4790	149
4814	148
5001	171
5012	159-161, 166
5014	152
5034	170
5038	156-157
5090	8-19, 161, 217
5112	162-165
5114	153
5190	162-165
5191	20-22, 163-165
5192	156, 159-160, 166
5201	171
5212	166-167
5214	154
5234	170
5238	157, 167
5290	157, 167
5301	171
5312	169

ARTICLE PAGE

5314	155
5334	170
5338	158
5401	171
5412	169
5414	154
5434	170
5438	158
5512	169
5514	155
5612	167
5614	154
5634	171
5638	158
5701	171
5712	167
5734	170
5738	158
5812	169
5814	154
5838	158
5901	171
5912	169
5934	170
6001	196
6012	188-189, 197
6015	197
6034	194-195
6038	186
6090	188-189, 194, 196
6100	174-176, 184
6105	177
6110	178-179
6112	190-192
6113	181
6115	181
6120	180
6125	180
6127	180
6130	183
6134	195
6135	182
6137	183
6138	186
6145	181
6160	184
6190	186, 190, 192
6201	197
6212	193
6234	195
6238	187
6601	171
6612	193
6614	187
6634	195
6638	187
6701	197
6712	193
6715	197
6734	195
6801	197
6812	193
6834	195
6838	187
6910	184
6909	184

ARTICLE PAGE

6915	184
6920	184
6921	184
7100	104
7200	105
7300	106
7400	107
7514	109
7614	107
7638	107
7690	107
7700	109-110
7800	110-111
7801	110
7802	111
7803	110
8010	199
8020	199
8030	199
8040	200
8060	200
8070	200
8200	201
8205	202
8210	202
8215	202
8220	202
8290	201-203
8300	203
8305	205
8390	203
8395	205
8400	206
8450	206
8610	205
9000	207
9001	208
9003	207
9005	208
9006	208
9007	208
9008	208
9010	209
9101	210
9105	210
9115	210
9190	218
9200	211-212
9210	211
9211	211
9400	212
9410	212
9490	218
9500	212
9510	212
9605	214
9606	214
9610	214
9611	214
9620	214
9705	215
P1000	42-43
P1005	43

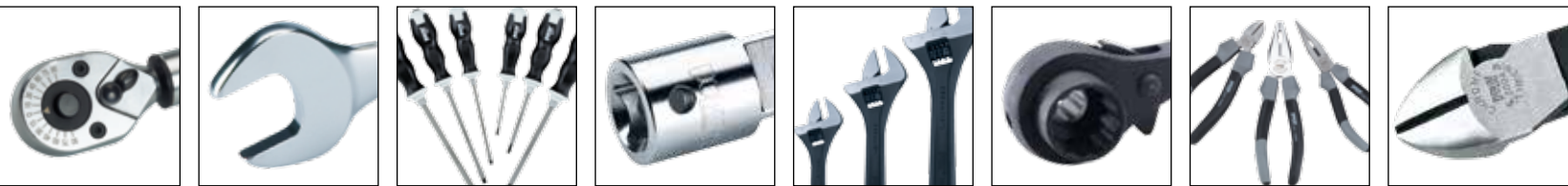

SHIP SUPPLY